

OPTO 22 NETWORK LED DIMMER USER'S GUIDE

Form 2038-150619—June 2015

OPTO 22
Automation made simple.

43044 Business Park Drive • Temecula • CA 92590-3614
Phone: 800-321-OPTO (6786) or 951-695-3000
Fax: 800-832-OPTO (6786) or 951-695-2712
www.opto22.com

Product Support Services

800-TEK-OPTO (835-6786) or 951-695-3080
Fax: 951-695-3017
Email: support@opto22.com
Web: support.opto22.com

Opto 22 Network LED Dimmer User's Guide
Form 2038-150619—June 2015

Copyright © 2012–2015 Opto 22.

All rights reserved.

Printed in the United States of America.

The information in this manual has been checked carefully and is believed to be accurate; however, Opto 22 assumes no responsibility for possible inaccuracies or omissions. Specifications are subject to change without notice.

Opto 22 warrants all of its products to be free from defects in material or workmanship for 30 months from the manufacturing date code. This warranty is limited to the original cost of the unit only and does not cover installation, labor, or any other contingent costs. Opto 22 I/O modules and solid-state relays with date codes of 1/96 or newer are guaranteed for life. This lifetime warranty excludes reed relay, SNAP serial communication modules, SNAP PID modules, and modules that contain mechanical contacts or switches. Opto 22 does not warrant any product, components, or parts not manufactured by Opto 22; for these items, the warranty from the original manufacturer applies. These products include, but are not limited to, OptoTerminal-G70, OptoTerminal-G75, and Sony Ericsson GT-48; see the product data sheet for specific warranty information. Refer to Opto 22 form number 1042 for complete warranty information.

Wired+Wireless controllers and brains are licensed under one or more of the following patents: U.S. Patent No(s). 5282222, RE37802, 6963617; Canadian Patent No. 2064975; European Patent No. 1142245; French Patent No. 1142245; British Patent No. 1142245; Japanese Patent No. 2002535925A; German Patent No. 60011224.

Opto 22 FactoryFloor, *groov*, Optomux, and Pamux are registered trademarks of Opto 22. Generation 4, *groov* Server, ioControl, ioDisplay, ioManager, ioProject, ioUtilities, *mistic*, Nvio, Nvio.net Web Portal, OptoConnect, OptoControl, OptoDataLink, OptoDisplay, OptoEMU, OptoEMU Sensor, OptoEMU Server, OptoOPCServer, OptoScript, OptoServer, OptoTerminal, OptoUtilities, PAC Control, PAC Display, PAC Manager, PAC Project, SNAP Ethernet I/O, SNAP I/O, SNAP OEM I/O, SNAP PAC System, SNAP Simple I/O, SNAP Ultimate I/O, and Wired+Wireless are trademarks of Opto 22.

ActiveX, JScript, Microsoft, MS-DOS, VBScript, Visual Basic, Visual C++, Windows, and Windows Vista are either registered trademarks or trademarks of Microsoft Corporation in the United States and other countries. Linux is a registered trademark of Linus Torvalds. Unicenter is a registered trademark of Computer Associates International, Inc. ARCNET is a registered trademark of Datapoint Corporation. Modbus is a registered trademark of Schneider Electric, licensed to the Modbus Organization, Inc. Wiegand is a registered trademark of Sensor Engineering Corporation. Nokia, Nokia M2M Platform, Nokia M2M Gateway Software, and Nokia 31 GSM Connectivity Terminal are trademarks or registered trademarks of Nokia Corporation. Sony is a trademark of Sony Corporation. Ericsson is a trademark of Telefonaktiebolaget LM Ericsson. CompactLogix, MicroLogix, SLC, and RSLogix are trademarks of Rockwell Automation. Allen-Bradley and ControlLogix are registered trademarks of Rockwell Automation. CIP and EtherNet/IP are trademarks of ODVA.

groov includes software developed by the OpenSSL Project for use in the OpenSSL Toolkit. (<http://www.openssl.org>)

All other brand or product names are trademarks or registered trademarks of their respective companies or organizations.

Opto 22
Automation Made Simple.

Table of Contents

Installation and Use	1
Introduction	1
Manual and System Control	1
For Help	2
Configuring the Network LED Dimmer	2
Setting DIP Switches	3
For DMX	3
For Modbus/ASCII and Optomux	3
For Modbus/ASCII	3
Installing and Wiring the Network LED Dimmer.....	4
Wiring the Serial Network	4
Wiring Loads and Power	5
Testing	6
Controlling LEDs Manually.....	6
Controlling LEDs through a Serial Network	6
Using the DMX Protocol	6
Functions Available in Modbus/ASCII and Optomux	7
Determining Brightness Value	7
Writing and Reading Brightness Values	8
Determining Ramp Time Value	9
Using the Modbus/ASCII Protocol	10
Supported Function Codes	10
Register Map	10
Using the Optomux Protocol	11
Troubleshooting	12
Test power and field wiring	12
Check serial network wiring	13
Check DIP switches	13
If you're using Modbus... ..	13
If you're using Optomux... ..	13
Specifications.....	14
Connectors and Indicators	15
Recommended Cables	15
Dimensional Drawings	16

Address Charts	17
Introduction	17
Modbus/ASCII Addresses	18
Optomux Addresses	19
DMX Addresses	21

Installation and Use

OPTO 22

Introduction

The Opto 22 Network LED Dimmer is a constant voltage PWM (pulse width modulation) dimmer that controls light-emitting diodes (LEDs).

The Network LED Dimmer is suitable for 12/24 VDC constant voltage LED assemblies: lamps, bulbs, strips, bars, and rope. It can also be used for other resistive-type loads.

Pulse width modulation provides linear dimming with minimal color shift and no flicker. The Network LED Dimmer acts by controlling the amount of power sent to the LEDs, rapidly changing the state from on to off. This high switching frequency makes dimming efficient and effective for LEDs.

The Network LED Dimmer includes a serial communications port, a test pushbutton, and two external indicator lights.

Manual and System Control

With the Network LED Dimmer, you can control LEDs either manually or through a serial network, to incorporate LED control into existing building, automation, and lighting control systems.

- For manual control, use a momentary pushbutton wired to the dimmer. A test pushbutton is also built into the unit.
- For system control, use one of these standard serial protocols: DMX512-A, Modbus/ASCII, or Optomux.

The Network LED Dimmer uses an RS-485 serial network, and up to 128 dimmers can be on the same serial link (total for all protocols).



For Help

If you have difficulty using the Network LED Dimmer and cannot find the help you need in this user's guide, contact Opto 22 Product Support:

Phone: 800-TEK-OPTO (800-835-6786)
951-695-3080
(Hours are Monday through Friday,
7 a.m. to 5 p.m. Pacific Time)

NOTE: Email messages and phone calls to Opto 22 Product Support are grouped together and answered in the order received.

Fax: 951-695-3017

Email: support@opto22.com

Opto 22 website: www.opto22.com

Configuring the Network LED Dimmer

NOTE: If you are using the Network LED Dimmer for manual control only, skip this section. Go to [page 4](#).

Before you install the Network LED Dimmer for use on a serial network, you'll need to know:

- Protocol you'll be using: DMX, Modbus/ASCII, or Optomux
- Address for the dimmer on the serial network
- Position of the dimmer on the network: is it the last physical device on the link?
- For Modbus, parity and baud rate
- For Optomux, baud rate

1. Hold the dimmer with the screw wiring connectors at the top and the serial connector at the bottom, as shown.
2. Open the Network LED Dimmer's case by squeezing the sides and lifting off the cover. Avoid touching the circuit board.
3. Use the two red blocks of white DIP switches to set protocol, address, termination, and parity and baud rate (if applicable).

IMPORTANT: Ignore on/off indications on the DIP switches. Hold the Dimmer as shown and follow diagrams to set the switches.

4. To determine the correct switch settings, use one of the following:
 - If you have a smart phone or tablet, scan the QR code that's on the inside of the Dimmer's cover and follow the link. Tap Configuring > Set Configuration.
 - Or go to op22.co/LED-SPCV-LV100W and choose Configuring > Set Configuration.
 - Or use the DIP switch diagrams on the following page and in the appendix.



- When you have finished setting DIP switches, continue with "Installing and Wiring the Network LED Dimmer" on page 4.

Setting DIP Switches



IMPORTANT: Make sure you hold the Network LED Dimmer with the screw wiring connectors at the top and the serial connector at the bottom. Ignore on/off indications on the switches and follow diagrams below.

S2 switches determine baud rate, protocol, and termination. See details below.



This switch must be up in all cases.

Key

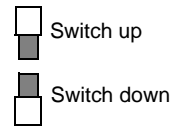

For Modbus/ASCII and Optomux

Baud rate switches

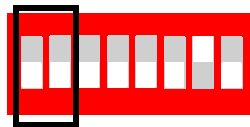

		9600
		19,200
		115,200
		230.400

Protocol switches

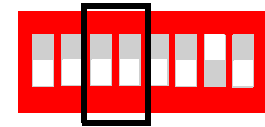

		Optomux
		Modbus
		DMX
		Reserved



S1 switches determine address and parity.

Parity applies to Modbus/ASCII only. For addresses, see [page 17](#).

For Modbus/ASCII

Parity switch

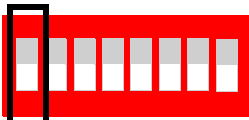

	Even Parity
	No parity

Termination switch

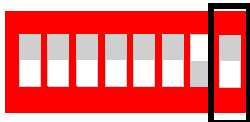

	End of link (Terminated)
	Middle of link

For DMX

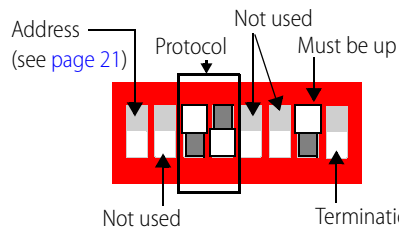

Not used
Termination:
Up = End of link (Terminated)
Down = Middle of link

Installing and Wiring the Network LED Dimmer

1. Determine where you want to mount the dimmer.

NOTE: In order to meet maximum output power specs, the dimmer must be mounted on a flat, thermally conductive surface (for example, steel or aluminum).

2. Using two #8 or #10 screws suited to the mounting surface's construction, install the dimmer through the screw holes on each end (see dimensional diagram on [page 16](#)).

Wiring the Serial Network

1. For all serial networks (DMX, Modbus/ASCII, and Optomux), use one set of three terminals on the serial connector as shown in the "Network Connections" diagram, below. If the dimmer is in the middle of the serial link, use the other set of three terminals for daisy chaining to the next device. If you are using DMX, use connector adapters as necessary to connect the dimmer to a DMX cable.

See "Recommended Cables" on [page 15](#).

2. Terminate the devices at both ends of the RS-485 link, typically at the light controller (the master) and at the last dimmer. If a Network LED Dimmer is at an end, set its termination DIP switch as shown in "Setting DIP Switches" on [page 3](#).
3. Bias the network at one location only (typically the master).

Network Connections

NOTE: Controller (master) must provide bias.

End of link.
Set termination.

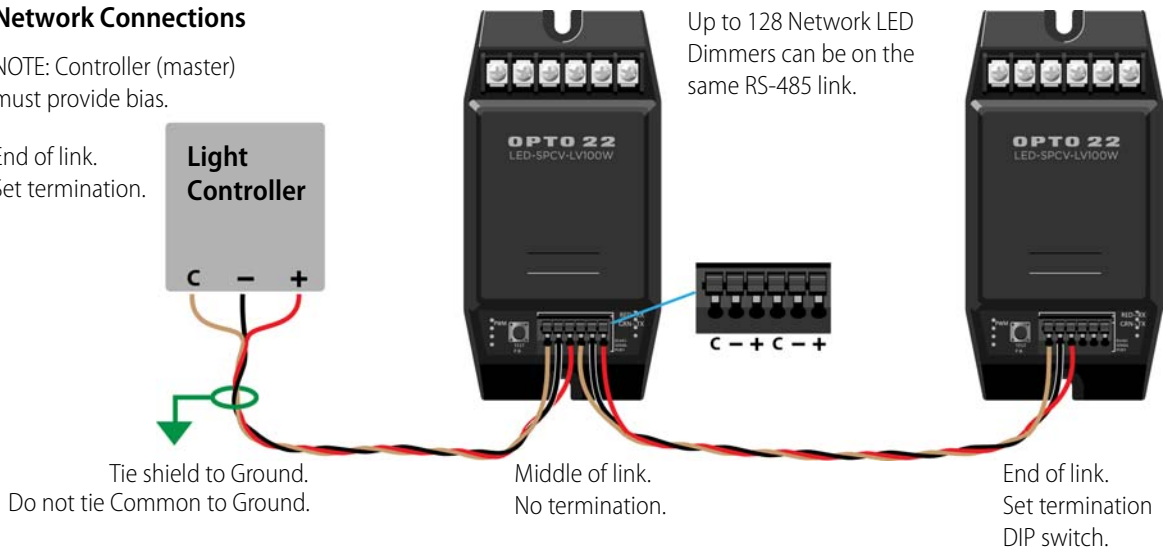

	Terminal	Master	Dimmer	Last Dimmer
Data +	+	+ ——— + ——— +		
Data -	-	- ——— - ——— -		
Signal common	C	C ——— C ——— C		
Cable shield	n/a	Tie to ground at one location only		

Connection to DMX Cable

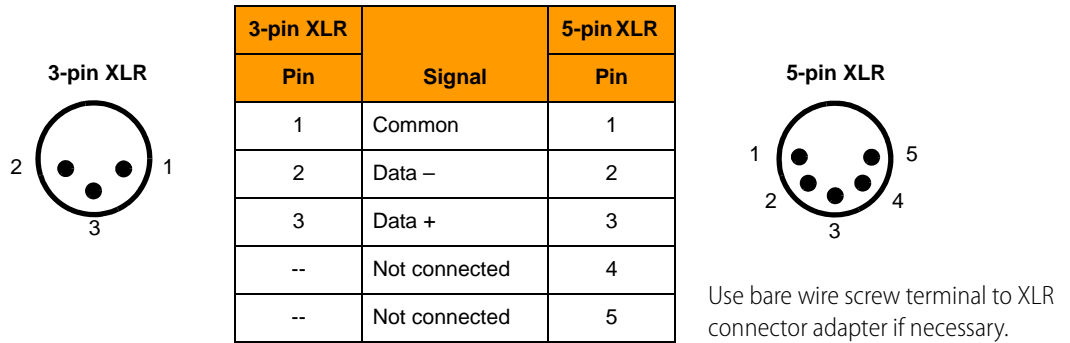

Wiring Loads and Power

1. Wire the middle two screw connectors to the LED load as shown in the diagram below.
2. If you are using a separate momentary pushbutton (typically a doorbell or other simple normally open pushbutton), wire it to the two screw connectors as shown.
3. Wire a 12 or 24 VDC power supply to the other two screw connectors.

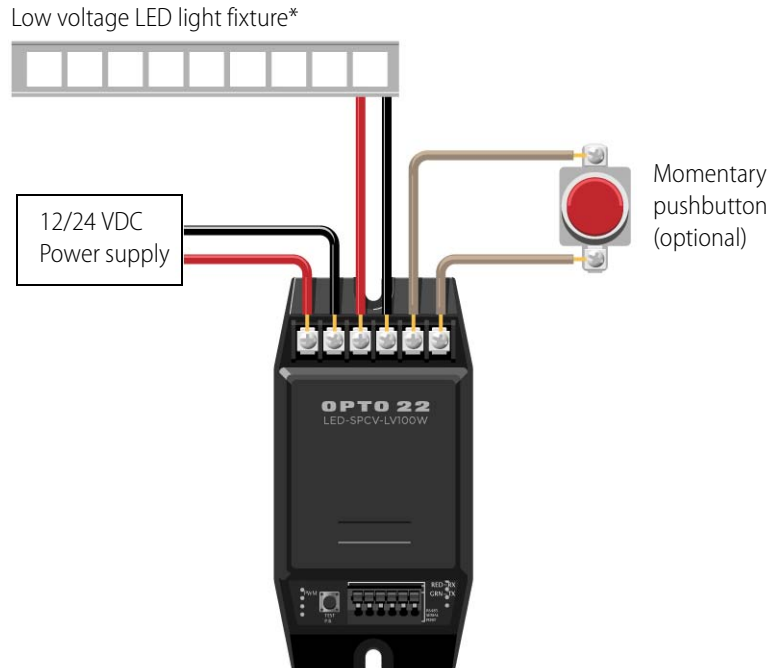

* NOTE: Pre-manufactured LED light fixtures have a resistor built in. If you are building your own assembly from LED components, you must include an appropriate resistor.

Testing

1. Test the unit by pressing the built-in test pushbutton:

To turn on or off:	Push briefly
To ramp up or down:	Push and hold; let go at the level of brightness you want

Once you have ramped to the level you want, you can push briefly to turn LEDs off. When you push again to turn them back on, the setting is retained and they will be at the same level of brightness you set before.

2. When you have finished wiring and testing, carefully set the dimmer's cover back in place and snap it closed.

Controlling LEDs Manually

The built-in pushbutton on the Network LED Dimmer provides manual control for testing connections.

For manual control beyond testing, you can wire your own momentary, normally open pushbutton to the dimmer. Typical pushbuttons that work with the Network LED Dimmer are doorbells or similar simple pushbuttons. See [“Wiring Loads and Power” on page 5](#) for a wiring diagram.

Controlling LEDs through a Serial Network

You can control LEDs with the Network LED Dimmer using any of three serial protocols:

- DMX—See [page 6](#).
- Modbus/ASCII—See [page 10](#).
- Optomux—See [page 11](#).

Using the DMX Protocol

The Network LED Dimmer supports the DMX512-A protocol over serial.

IMPORTANT: *The Opto 22 Network LED Dimmer is a single-channel dimmer, so it occupies just one slot. (A slot is any one of the data bytes within the DMX packet.)*

For details on the DMX protocol, visit <http://www.opendmx.net/index.php/DMX512-A>. The *Protocol* and *Timings* sections may be especially useful.

Functions Available in Modbus/ASCII and Optomux

If you're using Modbus or Optomux protocols with the Network LED Dimmer, you have five functions available:

Function	Modbus parameter	Optomux command	Method
Set LED brightness to a specific percentage between zero and 100% (no ramping)	Brightness (Read/Write)	Set/Read Brightness	Uses a logarithmic table* in the Network LED Dimmer
Ramp LEDs up or down to a specific percentage of brightness	Ramp to Brightness	Ramping	Uses a logarithmic table* in the Network LED Dimmer
Ramp LEDs up or down over a specified length of time	Ramp Time	Ramping	Uses a logarithmic table* in the Network LED Dimmer
Set LED level using the PWM duty cycle	Duty Cycle (Read/Write)	Set/Read Duty	Uses linear values*
Toggle on/off	Toggle	Toggle	Uses a logarithmic table in the Network LED Dimmer or equivalent linear values.

*The human eye sees light logarithmically, so the logarithmic table is designed to produce the effect the human eye expects. For example, if brightness is set at 50%, the human eye will perceive LEDs to be halfway to full brightness. The PWM duty cycle uses linear values, however; a 50% duty cycle will not necessarily appear to the eye as halfway to full brightness.

The logarithmic table for Brightness goes from 0 to 255. Zero represents no brightness (LEDs off) and 255 represents full brightness (LEDs fully lit). A value of 127 represents 50% brightness.

Linear values in the PWM duty cycle go from 0 to 32,767 (essentially, they are counts). A value of 16,383 represents a 50% duty cycle (which is not the same as 50% brightness).

Most applications will use the logarithmic table, but the duty cycle is available if you need this low-level control.

Determining Brightness Value

IMPORTANT: Brightness values are 16-bit values with the lower 8 bit (the least significant byte) set to 0. The Dimmer ignores the lower 8 bits; that is, it treats them like zeros.

The reason values are in the most significant instead of the least significant byte is for future development. We'll be able to offer greater resolution in the future and still keep existing code working correctly.

Brightness values range from 0–255. A value of 0 means LEDs are off. A value of 255 means LEDs are fully on. To determine the brightness value to use:

$$\frac{\text{Target\%} * 255 * 256}{100} = \text{Brightness value}$$

Example: Suppose you want to set LEDs to 35% brightness:

$$\frac{35 * 255 * 256}{100} = 22848 \text{ (dec)} = 5940 \text{ (hex)}$$

Because the Dimmer ignores the lower 8 bits, it will use a hex value of 5900.

See the following page for values to use.

Writing and Reading Brightness Values

The following table shows the values to use when writing or reading brightness.

Target Percent	16-bit Brightness Value (dec)	16-bit Brightness Value (hex)
0	0	0000
1	768	0300
2	1280	0500
3	2048	0800
4	2560	0A00
5	3328	0D00
6	3840	0F00
7	4608	1200
8	5120	1400
9	5888	1700
10	6656	1A00
11	7168	1C00
12	7936	1F00
13	8448	2100
14	9216	2400
15	9728	2600
16	10496	2900
17	11008	2B00
18	11776	2E00
19	12288	3000
20	13056	3300
21	13824	3600
22	14336	3800
23	15104	3B00
24	15616	3D00
25	16384	4000
26	16896	4200
27	17664	4500
28	18176	4700
29	18944	4A00
30	19712	4D00

Target Percent	16-bit Brightness Value (dec)	16-bit Brightness Value (hex)
31	20224	4F00
32	20992	5200
33	21504	5400
34	22272	5700
35	22784	5900
36	23552	5C00
37	24064	5E00
38	24832	6100
39	25344	6300
40	26112	6600
41	26880	6900
42	27392	6B00
43	28160	6E00
44	28672	7000
45	29440	7300
46	29952	7500
47	30720	7800
48	31232	7A00
49	32000	7D00
50	32768	8000
51	33280	8200
52	34048	8500
53	34560	8700
54	35328	8A00
55	35840	8C00
56	36608	8F00
57	37120	9100
58	37888	9400
59	38400	9600
60	39168	9900
61	39936	9C00

Target Percent	16-bit Brightness Value (dec)	16-bit Brightness Value (hex)
62	40448	9E00
63	41216	A100
64	41728	A300
65	42496	A600
66	43008	A800
67	43776	AB00
68	44288	AD00
69	45056	B000
70	45824	B300
71	46336	B500
72	47104	B800
73	47616	BA00
74	48384	BD00
75	48896	BF00
76	49664	C200
77	50176	C400
78	50944	C700
79	51456	C900
80	52224	CC00
81	52992	CF00

Target Percent	16-bit Brightness Value (dec)	16-bit Brightness Value (hex)
82	53504	D100
83	54272	D400
84	54784	D600
85	55552	D900
86	56064	DB00
87	56832	DE00
88	57344	E000
89	58112	E300
90	58880	E600
91	59392	E800
92	60160	EB00
93	60672	ED00
94	61440	F000
95	61952	F200
96	62720	F500
97	63232	F700
98	64000	FA00
99	64512	FC00
100	65280	FF00

Determining Ramp Time Value

Ramp Time values range from 0–255, equivalent to 0.262 - 66.8 seconds. By default, Ramp Time is set to 12 decimal (0x0C).

- A value of 0 sets Ramp Time to the default.
- Values 1–255 set the (full-scale ramp time in milliseconds)/256. Regardless of the value, ramping logic will update LED brightness no more than once per PWM Period (4.2 ms).

$$\frac{1000 * \text{Duration in sec}}{(\text{High\%} - \text{Low\%})} * \frac{100}{256} = \text{Ramp Time value}$$

Example 1: Suppose you want to ramp LEDs up from 0% to 100% brightness in 10 seconds:

$$\frac{1000 * 10}{100} * \frac{100}{256} = \frac{10,000}{100} * \frac{100}{256} = 39 \text{ decimal (0x27)}$$

Example 2: Ramp LEDs down from 100% to 25% brightness in 30 seconds:

$$\frac{1000 * 30}{75} * \frac{100}{256} = \frac{30,000}{75} * \frac{100}{256} = 156 \text{ decimal (0x9C)}$$

Using the Modbus/ASCII Protocol

The Network LED Dimmer supports Modbus ASCII mode and acts as a slave on the Modbus network. For details on the Modbus protocol, see the *Modbus over Serial Line Specification and Implementation Guide* at <http://www.Modbus.org/>.

The bit sequence in Modbus ASCII mode is:

Bits (1=LSB):	1	2	3	4	5	6	7	8	9	10	
With Parity:	Start	1	2	3	4	5	6	7	Parity	Stop	= 7 data bits, 1 parity bit, 1 stop bit
Without Parity:	Start	1	2	3	4	5	6	7	Stop	Stop	= 7 data bits, no parity, 2 stop bits

Supported Function Codes

Function	Code		Description
	Hex	Dec.	
Read Holding Registers	0x03	3	Reads a contiguous block from 1 to 125 16-bit registers.
Write Single Register	0x06	6	Writes a single 16-bit register.
Write Multiple Registers	0x10	16	Writes a contiguous block from 1 to 123 16-bit registers.
Report Slave ID	0x11	17	Reports the following: [Slave ID]: A 1-byte slave I.D. of 0x51 [Run Indicator Status]: always 0xFF [Additional Data]: A 4-byte Hardware version date in format mmddyyyy. mm = month in hex; dd = day in hex; yyyy = year in hex (Ex: 0A0107DC = Oct 1, 2012) Followed by a 4-byte Firmware number and revision (Ex: 93010002 = number 9301, revision 2) Followed by four Reserved bytes that are zero-filled.

Register Map

NOTE: The Dimmer has only one channel. However, you can still read and write to register numbers 2–16, for example, in order to use Read Holding Registers (0x03) and Write Multiple Registers (0x10). If you are writing, the Dimmer ignores any data for the additional register numbers (2–16 in this example); if reading, 0x0000 is returned for each register except the first one.

Register Number	Register Address	Parameter	Access
1	0	Duty Cycle	Read/Write
17	16	Brightness	Read/Write
33	32	Ramp Time	Write
49	48	Ramp to Brightness	Write
65	64	Toggle*	Write
--	80–127	Reserved**	--

* Any write to this register causes a toggle. The value written doesn't matter.

** Register Addresses 80 - 127 are reserved. Reading or writing to these registers will result in an exception response (Illegal Data Address, code 0x02).

For details on using the Duty Cycle, Brightness, Ramp Step Time, and Ramp to Brightness parameters, see “[Functions Available in Modbus/ASCII and Optomux](#)” on page 7.

Using the Optomux Protocol

The Network LED Dimmer supports the Optomux protocol in ASCII mode.

NOTE: The Network LED Dimmer supports a 2-wire RS-485 link and 2-pass mode only. There are no options for 4-wire or 4-pass mode.

The bit sequence in Optomux ASCII mode is:

Bits (1=LSB):	1	2	3	4	5	6	7	8	9	10
No Parity:	Start	1	2	3	4	5	6	7	MSB (always 0)	Stop

For further details of the Optomux protocol, see the [Optomux Protocol Guide](#) (form 1572).

The Optomux commands shown in the following table can be used for the Network LED Dimmer. For PC-based drivers to communicate using the Optomux protocol from your Windows-based application, see the [OptoDriver Toolkit](#), a free developer toolkit available on our website.

- The **[positions]** field can vary depending on the command. Because the Network LED Dimmer has a single channel, the referenced position must be 0x0001.

NOTE: If you are using the Optomux driver, send 0 for [positions]. Since the Dimmer has only one channel, it is channel 0 in the driver.

- All examples assume a Network LED Dimmer address of 0x80.
- In examples, checksum is shown when known, or question marks (??) are used as placeholders.
- Values beginning with 0x indicate hex value: for example, 0x01 is hex 01.
- For details on using Duty, Brightness, and Ramping, see “[Functions Available in Modbus/ASCII and Optomux](#)” on page 7.

Command Name	ASCII Char	Format	Driver Command	Description	Example
Power Up Clear, PUC	A	A	0	Functions only if it is the first command sent after powerup or reset. A power-up clear expected error is returned if any other command is sent first.	>80AA9cr
Reset	B	B	1	Resets the Dimmer unit to powerup conditions.	>80BAAc
Identify Unit Type	F	F	5	Read Device Unit Type. Returns an 8-bit ASCII hex value of 0x51 for the dimmer.	Request: >80FAEc Response: A5166cr
Read Device Info	,	,	80	Note: This character is ASCII 96 decimal (0x60). Reads device information. Returns a 96-bit ASCII hex value composed of 32 bits ASCII hex for each field in the following order: Hardware Version Date Firmware Number and Revision Reserved	Request: >80 C8cr Response: Ammdyyyycccccvvrrrrrrrr??cr mmddyyyy is Hardware Version Date. mm = month in hex, dd = day in hex, yyyy = year in hex. Ex: 0A0107DC is Oct 1, 2012; cccccvvv is Firmware Version. cccc = part number (always 9301); vvvv = revision number. Ex1: 93010001 = Program 9301 revision 1. Ex2: 9301000A = Program 9301 revision 10. rrrrrrr is reserved and reads all zeros.
Toggle	J	J [positions]	9	Functionally equivalent to pressing the push button for a short time (a tap).	Request: >80J000173cr Response: Acr

Command Name	ASCII Char	Format	Driver Command	Description	Example
Set Brightness	W	W [positions] [data]	53	Set the brightness from the dimmer's logarithmic table. [positions] is 0001. [data] is a 16-bit ASCII hex value. The logarithmic table is indexed with an 8-bit value in the most significant byte of the 16-bit [data] field.	See “Determining Brightness Value” on page 7 and “Writing and Reading Brightness Values” on page 8 . Request: >80W00013F0059cr Dimmer is set to a value of 0x3F00, or quarter-scale brightness.
Read Brightness	c	c [positions]	60	Read 16-bit ASCII hex value of current logarithmic table index indicating brightness level for the dimmer. [positions] is 0001.	See “Writing and Reading Brightness Values” on page 8 Request: >80c00018Ccr Read dimmer brightness level. Response: Axyy??cr xx is 8-bit hex index of logarithmic table yy is 00
Set Duty Cycle	Y	Y [positions] [data]	56	Low-level write to PWM duty cycle register. [positions] is 0001. [data] is a 16-bit ASCII hex value with valid range from 0x0000 - 0x7FFF.	Request: >80Y0001199982cr Writes a value of 0x1999, or 20% duty cycle.
Read Duty Cycle	d	d [positions]	61	Low-level read access of PWM duty cycle register. [positions] is 0001.	Request: >80d00018Dcr Read 16-bit duty cycle. Response: Axyy??cr xx is most significant byte and yy least significant byte of register value.
Ramping	Z	Z [positions] [modifier] [data]	25	Ramp channels to specific brightness level from current brightness. [positions] is 0001. [modifier] is a 4-bit ASCII hex value. Send this command twice: first set the rate (H), then start the ramp (I). <ul style="list-style-type: none"> Set [modifier] to ASCII char 'H' to set Ramp Time. For Ramp Time: [data] is an 8-bit ASCII hex value. If [data] is 0, default ramp time of 12 (0x0C) is used; if [data] is greater than 0 the ramp time will increase or decrease accordingly. Set [modifier] to ASCII char 'I' (capital letter i) to set Ramp-to-Brightness value and start the ramp. For Ramp-to-Brightness: [data] is a 16-bit ASCII hex value. The logarithmic table is indexed with an 8-bit value in the most significant byte of the 16-bit [data] field. 	See “Determining Ramp Time Value” on page 9 . <i>Ramp Time:</i> Request: >80Z0001H1531cr Sets dimmer to a ramp time of 0x15 <i>Ramp-to-Brightness:</i> Request: >80Z0001I7F00A9cr Sets dimmer ramp-to brightness level to 0x7F00, or mid-scale brightness

Troubleshooting

If the Network LED Dimmer isn't responding in the way you expect, try these suggestions.

Test power and field wiring

Once you have wiring connected, test the unit using the built-in pushbutton. See [“Connectors and Indicators” on page 15](#) for the pushbutton's location.

- If your LEDs don't turn on when you press the pushbutton, check the voltage connected to the Dimmer and check wiring to the LEDs.
- If your LEDs do turn on, then you know that wiring is correct.

Check serial network wiring

Remember that:

- The light controller (master) must provide bias.
- The first and last devices on the serial link must be terminated.
- A maximum of 128 Opto 22 Network LED Dimmers can be on one serial link.

Check DIP switches

Verify that DIP switches are set correctly for the unit's address, position on link, and other communication settings. The easiest way to check settings is:

- If you have a smart phone or tablet, scan the QR code that's on the inside of the Dimmer's cover and follow the link. Tap Configuring > Get Current Configuration.
- Or go to op22.co/LED-SPCV-LV100W and choose Configuring > Get Current Configuration.

Set the switches so they look like yours, then click the button to verify configuration.

If you're using Modbus...

To find out if communication is successful, check for errors or Modbus exception responses.

Remember that Modbus register numbers are different from register addresses. Register numbers start with 1; the corresponding register addresses start with 0. If you suspect this might be the issue, try offsetting by one and see if that fixes it.

If you're using Optomux...

Since the Network LED Dimmer is a single-channel unit, the referenced position for the [positions] field must be 0x0001.

If you're using Opto 22's Optomux driver with the Dimmer, use a zero for position. The driver automatically puts the correct 0x0001 value into the string.

Specifications

Nominal Input Voltage	12 or 24 VDC (Full range: 9–30 VDC)
Operating Current	20 mA @ 12 V, 0% duty cycle 30 mA with pushbutton pressed
Max. Output Power*	100 W @ 12 V: 8 A @ 50 °C ambient 100 W @ 24 V: 4 A @ 50 °C ambient Derate to 0 A @ 70 °C ambient
On-board Fuse	10 A automotive mini fuse (red)
Torque Specs	Recommended for 6-position screw connector: 6 in.-lb. (0.678 N-m)
External Pushbutton Excitation	Open Circuit Voltage: 8 VDC Typical (P.B. open) Short Circuit Current: 4 mA Typical (P.B. closed)
Protocols	DMX512-A, Modbus ASCII, Optomux
Serial Communication Link	1 RS-485 (shielded twisted-pair, 2 pair: one pair for data, one for common) port with duplicate terminal positions for easy daisy chaining
Max. Turnaround Delay	12 microseconds (Modbus and Optomux only)
Max. Dimmers on Link	124 Opto 22 Network LED Dimmers
Max. Distance	1000 feet (304.8 m.) at 115,200; 500 feet (152.4 m.) at 250,000
Selectable Data Rates (Baud)	DMX: 250,000 Modbus: 9600; 19,200; 115,200; 230,400 Optomux: 9600; 19,200; 115,200; 230,400
Address Range	DMX: 1–512 Modbus: 1–127** Optomux: 1–255**
Termination and Biasing***	Set DIP switch (inside case) if Dimmer is at the physical end of the link. Biasing must be supplied by master for the RS-485 link.
LEDs	TX/RX: Green = TX; Red = RX PWM: Intensifies as LEDs are ramped up; fully lit at duty cycle of 100%
PWM Frequency	244 Hz
PWM Period	4.2 milliseconds
PWM Resolution	Brightness commands are 8-bit logarithmic curve; duty cycle commands are 15-bit resolution
Max. Number of Ramp Steps	256 using logarithmic brightness curve; 32,768 if writing linear duty cycle
Ramp Time Parameter	(Optomux and Modbus protocols only) User selectable with range from 0–255
Operating Temperature	-20 to +70 °C
Storage Temperature	-20 to +85 °C
Humidity	0–95% humidity, non-condensing
Agency Approvals	UL, CE, CSA (all pending); RoHS
Warranty	30 months

*For rated power, mount to a flat, thermally conductive surface (steel, aluminum).

**Do not use address 0; it is the broadcast address.

***Both ends of the physical link must be terminated. Master must supply bias.

Connectors and Indicators



LED	Indicates	Meaning
TX/RX	Serial communication	Green = TX Red = RX
PWM	Dimming activity	Intensifies as LEDs are ramped up (off when duty cycle is 0%; fully lit when duty cycle is 100%)

Recommended Cables

The following cables are recommended for RS-485 serial communications. Other cables may be used, but keep in mind that low capacitance (less than 15 pF/ft.) is important for high-speed digital communication links. The cables listed below are all 24-gauge, 7x32 stranded, with 100-ohm nominal impedance and a capacitance of 12.5 pF/ft.

Two-Pair:
Belden P/N 8102 (with overall shield)
Belden P/N 9729 (individually shielded)
Belden P/N 8162 (individually shielded with overall shield)
Manhattan P/N M3475 (individually shielded with overall shield)

Use one pair for data (+/-) and the other for signal common. Connect the shield to ground. *Do not* connect common to ground.

Dimensional Drawings

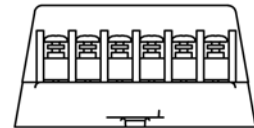
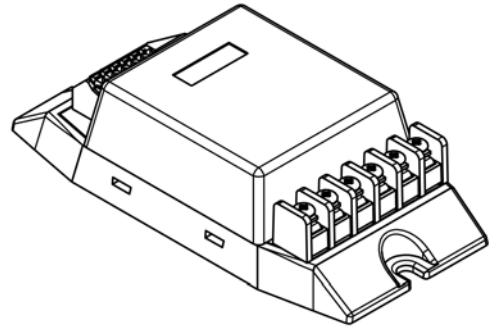
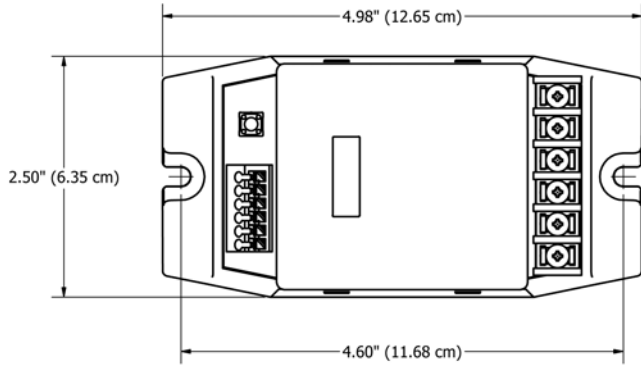

Address Charts

Introduction

This appendix shows how to set the serial network address of the Network LED Dimmer using its DIP switches. An even easier way to find out addresses is to use the online configurator:

- If you have a smartphone or tablet, scan the QR code that's on the inside of the Dimmer's cover and follow the link. Tap Configuring > Set Configuration.
- Or go to op22.co/LED-SPCV-LV100W and choose Configuring > Set Configuration.

IMPORTANT: Ignore on/off indications on the switches. Hold the Dimmer as shown and set switches up or down for the address you need.

See [page 3](#) for more about DIP switches. The number of switches used and the addresses that are available depend on the serial protocol you're using:

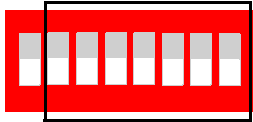
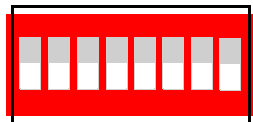
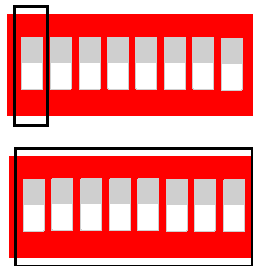
Protocol	Address range	Switches used	See diagrams on
Modbus/ASCII	1–127*	 S1	page 18
Optomux	1–255*	 S1	page 19
DMX	1–512	 S2 S1	page 21

* Do not use address 0; it is the broadcast address.

Modbus/ASCII Addresses

Modbus addresses use only seven of the DIP switches on S1. The last switch (on the far left, if you're looking at the dimmer with the screw wiring connectors at the top) is for parity (see [page 3](#)). Do not use address 0; it is the broadcast address.

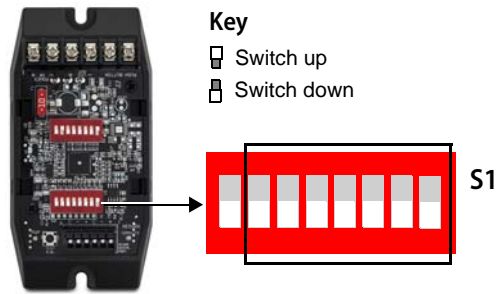

Addr	Switch Settings	Addr	Switch Settings	Addr	Switch Settings	Addr	Switch Settings
---	□□□□□□□	32	□□□□□□□	64	□□□□□□□	96	□□□□□□□
1	□□□□□□□	33	□□□□□□□	65	□□□□□□□	97	□□□□□□□
2	□□□□□□□	34	□□□□□□□	66	□□□□□□□	98	□□□□□□□
3	□□□□□□□	35	□□□□□□□	67	□□□□□□□	99	□□□□□□□
4	□□□□□□□	36	□□□□□□□	68	□□□□□□□	100	□□□□□□□
5	□□□□□□□	37	□□□□□□□	69	□□□□□□□	101	□□□□□□□
6	□□□□□□□	38	□□□□□□□	70	□□□□□□□	102	□□□□□□□
7	□□□□□□□	39	□□□□□□□	71	□□□□□□□	103	□□□□□□□
8	□□□□□□□	40	□□□□□□□	72	□□□□□□□	104	□□□□□□□
9	□□□□□□□	41	□□□□□□□	73	□□□□□□□	105	□□□□□□□
10	□□□□□□□	42	□□□□□□□	74	□□□□□□□	106	□□□□□□□
11	□□□□□□□	43	□□□□□□□	75	□□□□□□□	107	□□□□□□□
12	□□□□□□□	44	□□□□□□□	76	□□□□□□□	108	□□□□□□□
13	□□□□□□□	45	□□□□□□□	77	□□□□□□□	109	□□□□□□□
14	□□□□□□□	46	□□□□□□□	78	□□□□□□□	110	□□□□□□□
15	□□□□□□□	47	□□□□□□□	79	□□□□□□□	111	□□□□□□□
16	□□□□□□□	48	□□□□□□□	80	□□□□□□□	112	□□□□□□□
17	□□□□□□□	49	□□□□□□□	81	□□□□□□□	113	□□□□□□□
18	□□□□□□□	50	□□□□□□□	82	□□□□□□□	114	□□□□□□□
19	□□□□□□□	51	□□□□□□□	83	□□□□□□□	115	□□□□□□□
20	□□□□□□□	52	□□□□□□□	84	□□□□□□□	116	□□□□□□□
21	□□□□□□□	53	□□□□□□□	85	□□□□□□□	117	□□□□□□□
22	□□□□□□□	54	□□□□□□□	86	□□□□□□□	118	□□□□□□□
23	□□□□□□□	55	□□□□□□□	87	□□□□□□□	119	□□□□□□□
24	□□□□□□□	56	□□□□□□□	88	□□□□□□□	120	□□□□□□□
25	□□□□□□□	57	□□□□□□□	89	□□□□□□□	121	□□□□□□□
26	□□□□□□□	58	□□□□□□□	90	□□□□□□□	122	□□□□□□□
27	□□□□□□□	59	□□□□□□□	91	□□□□□□□	123	□□□□□□□
28	□□□□□□□	60	□□□□□□□	92	□□□□□□□	124	□□□□□□□
29	□□□□□□□	61	□□□□□□□	93	□□□□□□□	125	□□□□□□□
30	□□□□□□□	62	□□□□□□□	94	□□□□□□□	126	□□□□□□□
31	□□□□□□□	63	□□□□□□□	95	□□□□□□□	127	□□□□□□□

Optomux Addresses

Optomux addresses use all eight of the DIP switches on S1. S1 is the bottom bank of switches if you are looking at the dimmer with the screw wiring connectors at the top. Do not use address 0; it is the broadcast address.

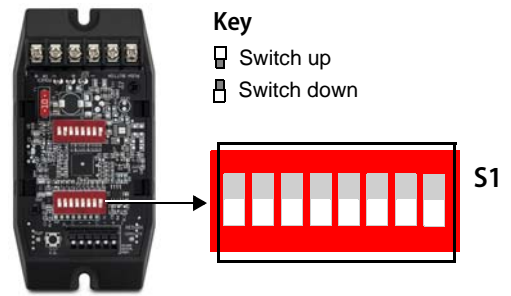

Addr	Switch Settings	Addr	Switch Settings	Addr	Switch Settings	Addr	Switch Settings	Addr	Switch Settings
---	<input type="checkbox"/> <input type="checkbox"/> <input type="checkbox"/> <input type="checkbox"/> <input type="checkbox"/> <input type="checkbox"/> <input type="checkbox"/> <input type="checkbox"/>	32	<input type="checkbox"/> <input type="checkbox"/> <input type="checkbox"/> <input type="checkbox"/> <input type="checkbox"/> <input type="checkbox"/> <input type="checkbox"/> <input type="checkbox"/>	64	<input type="checkbox"/> <input type="checkbox"/> <input type="checkbox"/> <input type="checkbox"/> <input type="checkbox"/> <input type="checkbox"/> <input type="checkbox"/> <input type="checkbox"/>	96	<input type="checkbox"/> <input type="checkbox"/> <input type="checkbox"/> <input type="checkbox"/> <input type="checkbox"/> <input type="checkbox"/> <input type="checkbox"/> <input type="checkbox"/>	128	<input type="checkbox"/> <input type="checkbox"/> <input type="checkbox"/> <input type="checkbox"/> <input type="checkbox"/> <input type="checkbox"/> <input type="checkbox"/> <input type="checkbox"/>
1	<input type="checkbox"/> <input type="checkbox"/> <input type="checkbox"/> <input type="checkbox"/> <input type="checkbox"/> <input type="checkbox"/> <input type="checkbox"/> <input type="checkbox"/>	33	<input type="checkbox"/> <input type="checkbox"/> <input type="checkbox"/> <input type="checkbox"/> <input type="checkbox"/> <input type="checkbox"/> <input type="checkbox"/> <input type="checkbox"/>	65	<input type="checkbox"/> <input type="checkbox"/> <input type="checkbox"/> <input type="checkbox"/> <input type="checkbox"/> <input type="checkbox"/> <input type="checkbox"/> <input type="checkbox"/>	97	<input type="checkbox"/> <input type="checkbox"/> <input type="checkbox"/> <input type="checkbox"/> <input type="checkbox"/> <input type="checkbox"/> <input type="checkbox"/> <input type="checkbox"/>	129	<input type="checkbox"/> <input type="checkbox"/> <input type="checkbox"/> <input type="checkbox"/> <input type="checkbox"/> <input type="checkbox"/> <input type="checkbox"/> <input type="checkbox"/>
2	<input type="checkbox"/> <input type="checkbox"/> <input type="checkbox"/> <input type="checkbox"/> <input type="checkbox"/> <input type="checkbox"/> <input type="checkbox"/> <input type="checkbox"/>	34	<input type="checkbox"/> <input type="checkbox"/> <input type="checkbox"/> <input type="checkbox"/> <input type="checkbox"/> <input type="checkbox"/> <input type="checkbox"/> <input type="checkbox"/>	66	<input type="checkbox"/> <input type="checkbox"/> <input type="checkbox"/> <input type="checkbox"/> <input type="checkbox"/> <input type="checkbox"/> <input type="checkbox"/> <input type="checkbox"/>	98	<input type="checkbox"/> <input type="checkbox"/> <input type="checkbox"/> <input type="checkbox"/> <input type="checkbox"/> <input type="checkbox"/> <input type="checkbox"/> <input type="checkbox"/>	130	<input type="checkbox"/> <input type="checkbox"/> <input type="checkbox"/> <input type="checkbox"/> <input type="checkbox"/> <input type="checkbox"/> <input type="checkbox"/> <input type="checkbox"/>
3	<input type="checkbox"/> <input type="checkbox"/> <input type="checkbox"/> <input type="checkbox"/> <input type="checkbox"/> <input type="checkbox"/> <input type="checkbox"/> <input type="checkbox"/>	35	<input type="checkbox"/> <input type="checkbox"/> <input type="checkbox"/> <input type="checkbox"/> <input type="checkbox"/> <input type="checkbox"/> <input type="checkbox"/> <input type="checkbox"/>	67	<input type="checkbox"/> <input type="checkbox"/> <input type="checkbox"/> <input type="checkbox"/> <input type="checkbox"/> <input type="checkbox"/> <input type="checkbox"/> <input type="checkbox"/>	99	<input type="checkbox"/> <input type="checkbox"/> <input type="checkbox"/> <input type="checkbox"/> <input type="checkbox"/> <input type="checkbox"/> <input type="checkbox"/> <input type="checkbox"/>	131	<input type="checkbox"/> <input type="checkbox"/> <input type="checkbox"/> <input type="checkbox"/> <input type="checkbox"/> <input type="checkbox"/> <input type="checkbox"/> <input type="checkbox"/>
4	<input type="checkbox"/> <input type="checkbox"/> <input type="checkbox"/> <input type="checkbox"/> <input type="checkbox"/> <input type="checkbox"/> <input type="checkbox"/> <input type="checkbox"/>	36	<input type="checkbox"/> <input type="checkbox"/> <input type="checkbox"/> <input type="checkbox"/> <input type="checkbox"/> <input type="checkbox"/> <input type="checkbox"/> <input type="checkbox"/>	68	<input type="checkbox"/> <input type="checkbox"/> <input type="checkbox"/> <input type="checkbox"/> <input type="checkbox"/> <input type="checkbox"/> <input type="checkbox"/> <input type="checkbox"/>	100	<input type="checkbox"/> <input type="checkbox"/> <input type="checkbox"/> <input type="checkbox"/> <input type="checkbox"/> <input type="checkbox"/> <input type="checkbox"/> <input type="checkbox"/>	132	<input type="checkbox"/> <input type="checkbox"/> <input type="checkbox"/> <input type="checkbox"/> <input type="checkbox"/> <input type="checkbox"/> <input type="checkbox"/> <input type="checkbox"/>
5	<input type="checkbox"/> <input type="checkbox"/> <input type="checkbox"/> <input type="checkbox"/> <input type="checkbox"/> <input type="checkbox"/> <input type="checkbox"/> <input type="checkbox"/>	37	<input type="checkbox"/> <input type="checkbox"/> <input type="checkbox"/> <input type="checkbox"/> <input type="checkbox"/> <input type="checkbox"/> <input type="checkbox"/> <input type="checkbox"/>	69	<input type="checkbox"/> <input type="checkbox"/> <input type="checkbox"/> <input type="checkbox"/> <input type="checkbox"/> <input type="checkbox"/> <input type="checkbox"/> <input type="checkbox"/>	101	<input type="checkbox"/> <input type="checkbox"/> <input type="checkbox"/> <input type="checkbox"/> <input type="checkbox"/> <input type="checkbox"/> <input type="checkbox"/> <input type="checkbox"/>	133	<input type="checkbox"/> <input type="checkbox"/> <input type="checkbox"/> <input type="checkbox"/> <input type="checkbox"/> <input type="checkbox"/> <input type="checkbox"/> <input type="checkbox"/>
6	<input type="checkbox"/> <input type="checkbox"/> <input type="checkbox"/> <input type="checkbox"/> <input type="checkbox"/> <input type="checkbox"/> <input type="checkbox"/> <input type="checkbox"/>	38	<input type="checkbox"/> <input type="checkbox"/> <input type="checkbox"/> <input type="checkbox"/> <input type="checkbox"/> <input type="checkbox"/> <input type="checkbox"/> <input type="checkbox"/>	70	<input type="checkbox"/> <input type="checkbox"/> <input type="checkbox"/> <input type="checkbox"/> <input type="checkbox"/> <input type="checkbox"/> <input type="checkbox"/> <input type="checkbox"/>	102	<input type="checkbox"/> <input type="checkbox"/> <input type="checkbox"/> <input type="checkbox"/> <input type="checkbox"/> <input type="checkbox"/> <input type="checkbox"/> <input type="checkbox"/>	134	<input type="checkbox"/> <input type="checkbox"/> <input type="checkbox"/> <input type="checkbox"/> <input type="checkbox"/> <input type="checkbox"/> <input type="checkbox"/> <input type="checkbox"/>
7	<input type="checkbox"/> <input type="checkbox"/> <input type="checkbox"/> <input type="checkbox"/> <input type="checkbox"/> <input type="checkbox"/> <input type="checkbox"/> <input type="checkbox"/>	39	<input type="checkbox"/> <input type="checkbox"/> <input type="checkbox"/> <input type="checkbox"/> <input type="checkbox"/> <input type="checkbox"/> <input type="checkbox"/> <input type="checkbox"/>	71	<input type="checkbox"/> <input type="checkbox"/> <input type="checkbox"/> <input type="checkbox"/> <input type="checkbox"/> <input type="checkbox"/> <input type="checkbox"/> <input type="checkbox"/>	103	<input type="checkbox"/> <input type="checkbox"/> <input type="checkbox"/> <input type="checkbox"/> <input type="checkbox"/> <input type="checkbox"/> <input type="checkbox"/> <input type="checkbox"/>	135	<input type="checkbox"/> <input type="checkbox"/> <input type="checkbox"/> <input type="checkbox"/> <input type="checkbox"/> <input type="checkbox"/> <input type="checkbox"/> <input type="checkbox"/>
8	<input type="checkbox"/> <input type="checkbox"/> <input type="checkbox"/> <input type="checkbox"/> <input type="checkbox"/> <input type="checkbox"/> <input type="checkbox"/> <input type="checkbox"/>	40	<input type="checkbox"/> <input type="checkbox"/> <input type="checkbox"/> <input type="checkbox"/> <input type="checkbox"/> <input type="checkbox"/> <input type="checkbox"/> <input type="checkbox"/>	72	<input type="checkbox"/> <input type="checkbox"/> <input type="checkbox"/> <input type="checkbox"/> <input type="checkbox"/> <input type="checkbox"/> <input type="checkbox"/> <input type="checkbox"/>	104	<input type="checkbox"/> <input type="checkbox"/> <input type="checkbox"/> <input type="checkbox"/> <input type="checkbox"/> <input type="checkbox"/> <input type="checkbox"/> <input type="checkbox"/>	136	<input type="checkbox"/> <input type="checkbox"/> <input type="checkbox"/> <input type="checkbox"/> <input type="checkbox"/> <input type="checkbox"/> <input type="checkbox"/> <input type="checkbox"/>
9	<input type="checkbox"/> <input type="checkbox"/> <input type="checkbox"/> <input type="checkbox"/> <input type="checkbox"/> <input type="checkbox"/> <input type="checkbox"/> <input type="checkbox"/>	41	<input type="checkbox"/> <input type="checkbox"/> <input type="checkbox"/> <input type="checkbox"/> <input type="checkbox"/> <input type="checkbox"/> <input type="checkbox"/> <input type="checkbox"/>	73	<input type="checkbox"/> <input type="checkbox"/> <input type="checkbox"/> <input type="checkbox"/> <input type="checkbox"/> <input type="checkbox"/> <input type="checkbox"/> <input type="checkbox"/>	105	<input type="checkbox"/> <input type="checkbox"/> <input type="checkbox"/> <input type="checkbox"/> <input type="checkbox"/> <input type="checkbox"/> <input type="checkbox"/> <input type="checkbox"/>	137	<input type="checkbox"/> <input type="checkbox"/> <input type="checkbox"/> <input type="checkbox"/> <input type="checkbox"/> <input type="checkbox"/> <input type="checkbox"/> <input type="checkbox"/>
10	<input type="checkbox"/> <input type="checkbox"/> <input type="checkbox"/> <input type="checkbox"/> <input type="checkbox"/> <input type="checkbox"/> <input type="checkbox"/> <input type="checkbox"/>	42	<input type="checkbox"/> <input type="checkbox"/> <input type="checkbox"/> <input type="checkbox"/> <input type="checkbox"/> <input type="checkbox"/> <input type="checkbox"/> <input type="checkbox"/>	74	<input type="checkbox"/> <input type="checkbox"/> <input type="checkbox"/> <input type="checkbox"/> <input type="checkbox"/> <input type="checkbox"/> <input type="checkbox"/> <input type="checkbox"/>	106	<input type="checkbox"/> <input type="checkbox"/> <input type="checkbox"/> <input type="checkbox"/> <input type="checkbox"/> <input type="checkbox"/> <input type="checkbox"/> <input type="checkbox"/>	138	<input type="checkbox"/> <input type="checkbox"/> <input type="checkbox"/> <input type="checkbox"/> <input type="checkbox"/> <input type="checkbox"/> <input type="checkbox"/> <input type="checkbox"/>
11	<input type="checkbox"/> <input type="checkbox"/> <input type="checkbox"/> <input type="checkbox"/> <input type="checkbox"/> <input type="checkbox"/> <input type="checkbox"/> <input type="checkbox"/>	43	<input type="checkbox"/> <input type="checkbox"/> <input type="checkbox"/> <input type="checkbox"/> <input type="checkbox"/> <input type="checkbox"/> <input type="checkbox"/> <input type="checkbox"/>	75	<input type="checkbox"/> <input type="checkbox"/> <input type="checkbox"/> <input type="checkbox"/> <input type="checkbox"/> <input type="checkbox"/> <input type="checkbox"/> <input type="checkbox"/>	107	<input type="checkbox"/> <input type="checkbox"/> <input type="checkbox"/> <input type="checkbox"/> <input type="checkbox"/> <input type="checkbox"/> <input type="checkbox"/> <input type="checkbox"/>	139	<input type="checkbox"/> <input type="checkbox"/> <input type="checkbox"/> <input type="checkbox"/> <input type="checkbox"/> <input type="checkbox"/> <input type="checkbox"/> <input type="checkbox"/>
12	<input type="checkbox"/> <input type="checkbox"/> <input type="checkbox"/> <input type="checkbox"/> <input type="checkbox"/> <input type="checkbox"/> <input type="checkbox"/> <input type="checkbox"/>	44	<input type="checkbox"/> <input type="checkbox"/> <input type="checkbox"/> <input type="checkbox"/> <input type="checkbox"/> <input type="checkbox"/> <input type="checkbox"/> <input type="checkbox"/>	76	<input type="checkbox"/> <input type="checkbox"/> <input type="checkbox"/> <input type="checkbox"/> <input type="checkbox"/> <input type="checkbox"/> <input type="checkbox"/> <input type="checkbox"/>	108	<input type="checkbox"/> <input type="checkbox"/> <input type="checkbox"/> <input type="checkbox"/> <input type="checkbox"/> <input type="checkbox"/> <input type="checkbox"/> <input type="checkbox"/>	140	<input type="checkbox"/> <input type="checkbox"/> <input type="checkbox"/> <input type="checkbox"/> <input type="checkbox"/> <input type="checkbox"/> <input type="checkbox"/> <input type="checkbox"/>
13	<input type="checkbox"/> <input type="checkbox"/> <input type="checkbox"/> <input type="checkbox"/> <input type="checkbox"/> <input type="checkbox"/> <input type="checkbox"/> <input type="checkbox"/>	45	<input type="checkbox"/> <input type="checkbox"/> <input type="checkbox"/> <input type="checkbox"/> <input type="checkbox"/> <input type="checkbox"/> <input type="checkbox"/> <input type="checkbox"/>	77	<input type="checkbox"/> <input type="checkbox"/> <input type="checkbox"/> <input type="checkbox"/> <input type="checkbox"/> <input type="checkbox"/> <input type="checkbox"/> <input type="checkbox"/>	109	<input type="checkbox"/> <input type="checkbox"/> <input type="checkbox"/> <input type="checkbox"/> <input type="checkbox"/> <input type="checkbox"/> <input type="checkbox"/> <input type="checkbox"/>	141	<input type="checkbox"/> <input type="checkbox"/> <input type="checkbox"/> <input type="checkbox"/> <input type="checkbox"/> <input type="checkbox"/> <input type="checkbox"/> <input type="checkbox"/>
14	<input type="checkbox"/> <input type="checkbox"/> <input type="checkbox"/> <input type="checkbox"/> <input type="checkbox"/> <input type="checkbox"/> <input type="checkbox"/> <input type="checkbox"/>	46	<input type="checkbox"/> <input type="checkbox"/> <input type="checkbox"/> <input type="checkbox"/> <input type="checkbox"/> <input type="checkbox"/> <input type="checkbox"/> <input type="checkbox"/>	78	<input type="checkbox"/> <input type="checkbox"/> <input type="checkbox"/> <input type="checkbox"/> <input type="checkbox"/> <input type="checkbox"/> <input type="checkbox"/> <input type="checkbox"/>	110	<input type="checkbox"/> <input type="checkbox"/> <input type="checkbox"/> <input type="checkbox"/> <input type="checkbox"/> <input type="checkbox"/> <input type="checkbox"/> <input type="checkbox"/>	142	<input type="checkbox"/> <input type="checkbox"/> <input type="checkbox"/> <input type="checkbox"/> <input type="checkbox"/> <input type="checkbox"/> <input type="checkbox"/> <input type="checkbox"/>
15	<input type="checkbox"/> <input type="checkbox"/> <input type="checkbox"/> <input type="checkbox"/> <input type="checkbox"/> <input type="checkbox"/> <input type="checkbox"/> <input type="checkbox"/>	47	<input type="checkbox"/> <input type="checkbox"/> <input type="checkbox"/> <input type="checkbox"/> <input type="checkbox"/> <input type="checkbox"/> <input type="checkbox"/> <input type="checkbox"/>	79	<input type="checkbox"/> <input type="checkbox"/> <input type="checkbox"/> <input type="checkbox"/> <input type="checkbox"/> <input type="checkbox"/> <input type="checkbox"/> <input type="checkbox"/>	111	<input type="checkbox"/> <input type="checkbox"/> <input type="checkbox"/> <input type="checkbox"/> <input type="checkbox"/> <input type="checkbox"/> <input type="checkbox"/> <input type="checkbox"/>	143	<input type="checkbox"/> <input type="checkbox"/> <input type="checkbox"/> <input type="checkbox"/> <input type="checkbox"/> <input type="checkbox"/> <input type="checkbox"/> <input type="checkbox"/>
16	<input type="checkbox"/> <input type="checkbox"/> <input type="checkbox"/> <input type="checkbox"/> <input type="checkbox"/> <input type="checkbox"/> <input type="checkbox"/> <input type="checkbox"/>	48	<input type="checkbox"/> <input type="checkbox"/> <input type="checkbox"/> <input type="checkbox"/> <input type="checkbox"/> <input type="checkbox"/> <input type="checkbox"/> <input type="checkbox"/>	80	<input type="checkbox"/> <input type="checkbox"/> <input type="checkbox"/> <input type="checkbox"/> <input type="checkbox"/> <input type="checkbox"/> <input type="checkbox"/> <input type="checkbox"/>	112	<input type="checkbox"/> <input type="checkbox"/> <input type="checkbox"/> <input type="checkbox"/> <input type="checkbox"/> <input type="checkbox"/> <input type="checkbox"/> <input type="checkbox"/>	144	<input type="checkbox"/> <input type="checkbox"/> <input type="checkbox"/> <input type="checkbox"/> <input type="checkbox"/> <input type="checkbox"/> <input type="checkbox"/> <input type="checkbox"/>
17	<input type="checkbox"/> <input type="checkbox"/> <input type="checkbox"/> <input type="checkbox"/> <input type="checkbox"/> <input type="checkbox"/> <input type="checkbox"/> <input type="checkbox"/>	49	<input type="checkbox"/> <input type="checkbox"/> <input type="checkbox"/> <input type="checkbox"/> <input type="checkbox"/> <input type="checkbox"/> <input type="checkbox"/> <input type="checkbox"/>	81	<input type="checkbox"/> <input type="checkbox"/> <input type="checkbox"/> <input type="checkbox"/> <input type="checkbox"/> <input type="checkbox"/> <input type="checkbox"/> <input type="checkbox"/>	113	<input type="checkbox"/> <input type="checkbox"/> <input type="checkbox"/> <input type="checkbox"/> <input type="checkbox"/> <input type="checkbox"/> <input type="checkbox"/> <input type="checkbox"/>	145	<input type="checkbox"/> <input type="checkbox"/> <input type="checkbox"/> <input type="checkbox"/> <input type="checkbox"/> <input type="checkbox"/> <input type="checkbox"/> <input type="checkbox"/>
18	<input type="checkbox"/> <input type="checkbox"/> <input type="checkbox"/> <input type="checkbox"/> <input type="checkbox"/> <input type="checkbox"/> <input type="checkbox"/> <input type="checkbox"/>	50	<input type="checkbox"/> <input type="checkbox"/> <input type="checkbox"/> <input type="checkbox"/> <input type="checkbox"/> <input type="checkbox"/> <input type="checkbox"/> <input type="checkbox"/>	82	<input type="checkbox"/> <input type="checkbox"/> <input type="checkbox"/> <input type="checkbox"/> <input type="checkbox"/> <input type="checkbox"/> <input type="checkbox"/> <input type="checkbox"/>	114	<input type="checkbox"/> <input type="checkbox"/> <input type="checkbox"/> <input type="checkbox"/> <input type="checkbox"/> <input type="checkbox"/> <input type="checkbox"/> <input type="checkbox"/>	146	<input type="checkbox"/> <input type="checkbox"/> <input type="checkbox"/> <input type="checkbox"/> <input type="checkbox"/> <input type="checkbox"/> <input type="checkbox"/> <input type="checkbox"/>
19	<input type="checkbox"/> <input type="checkbox"/> <input type="checkbox"/> <input type="checkbox"/> <input type="checkbox"/> <input type="checkbox"/> <input type="checkbox"/> <input type="checkbox"/>	51	<input type="checkbox"/> <input type="checkbox"/> <input type="checkbox"/> <input type="checkbox"/> <input type="checkbox"/> <input type="checkbox"/> <input type="checkbox"/> <input type="checkbox"/>	83	<input type="checkbox"/> <input type="checkbox"/> <input type="checkbox"/> <input type="checkbox"/> <input type="checkbox"/> <input type="checkbox"/> <input type="checkbox"/> <input type="checkbox"/>	115	<input type="checkbox"/> <input type="checkbox"/> <input type="checkbox"/> <input type="checkbox"/> <input type="checkbox"/> <input type="checkbox"/> <input type="checkbox"/> <input type="checkbox"/>	147	<input type="checkbox"/> <input type="checkbox"/> <input type="checkbox"/> <input type="checkbox"/> <input type="checkbox"/> <input type="checkbox"/> <input type="checkbox"/> <input type="checkbox"/>
20	<input type="checkbox"/> <input type="checkbox"/> <input type="checkbox"/> <input type="checkbox"/> <input type="checkbox"/> <input type="checkbox"/> <input type="checkbox"/> <input type="checkbox"/>	52	<input type="checkbox"/> <input type="checkbox"/> <input type="checkbox"/> <input type="checkbox"/> <input type="checkbox"/> <input type="checkbox"/> <input type="checkbox"/> <input type="checkbox"/>	84	<input type="checkbox"/> <input type="checkbox"/> <input type="checkbox"/> <input type="checkbox"/> <input type="checkbox"/> <input type="checkbox"/> <input type="checkbox"/> <input type="checkbox"/>	116	<input type="checkbox"/> <input type="checkbox"/> <input type="checkbox"/> <input type="checkbox"/> <input type="checkbox"/> <input type="checkbox"/> <input type="checkbox"/> <input type="checkbox"/>	148	<input type="checkbox"/> <input type="checkbox"/> <input type="checkbox"/> <input type="checkbox"/> <input type="checkbox"/> <input type="checkbox"/> <input type="checkbox"/> <input type="checkbox"/>
21	<input type="checkbox"/> <input type="checkbox"/> <input type="checkbox"/> <input type="checkbox"/> <input type="checkbox"/> <input type="checkbox"/> <input type="checkbox"/> <input type="checkbox"/>	53	<input type="checkbox"/> <input type="checkbox"/> <input type="checkbox"/> <input type="checkbox"/> <input type="checkbox"/> <input type="checkbox"/> <input type="checkbox"/> <input type="checkbox"/>	85	<input type="checkbox"/> <input type="checkbox"/> <input type="checkbox"/> <input type="checkbox"/> <input type="checkbox"/> <input type="checkbox"/> <input type="checkbox"/> <input type="checkbox"/>	117	<input type="checkbox"/> <input type="checkbox"/> <input type="checkbox"/> <input type="checkbox"/> <input type="checkbox"/> <input type="checkbox"/> <input type="checkbox"/> <input type="checkbox"/>	149	<input type="checkbox"/> <input type="checkbox"/> <input type="checkbox"/> <input type="checkbox"/> <input type="checkbox"/> <input type="checkbox"/> <input type="checkbox"/> <input type="checkbox"/>
22	<input type="checkbox"/> <input type="checkbox"/> <input type="checkbox"/> <input type="checkbox"/> <input type="checkbox"/> <input type="checkbox"/> <input type="checkbox"/> <input type="checkbox"/>	54	<input type="checkbox"/> <input type="checkbox"/> <input type="checkbox"/> <input type="checkbox"/> <input type="checkbox"/> <input type="checkbox"/> <input type="checkbox"/> <input type="checkbox"/>	86	<input type="checkbox"/> <input type="checkbox"/> <input type="checkbox"/> <input type="checkbox"/> <input type="checkbox"/> <input type="checkbox"/> <input type="checkbox"/> <input type="checkbox"/>	118	<input type="checkbox"/> <input type="checkbox"/> <input type="checkbox"/> <input type="checkbox"/> <input type="checkbox"/> <input type="checkbox"/> <input type="checkbox"/> <input type="checkbox"/>	150	<input type="checkbox"/> <input type="checkbox"/> <input type="checkbox"/> <input type="checkbox"/> <input type="checkbox"/> <input type="checkbox"/> <input type="checkbox"/> <input type="checkbox"/>
23	<input type="checkbox"/> <input type="checkbox"/> <input type="checkbox"/> <input type="checkbox"/> <input type="checkbox"/> <input type="checkbox"/> <input type="checkbox"/> <input type="checkbox"/>	55	<input type="checkbox"/> <input type="checkbox"/> <input type="checkbox"/> <input type="checkbox"/> <input type="checkbox"/> <input type="checkbox"/> <input type="checkbox"/> <input type="checkbox"/>	87	<input type="checkbox"/> <input type="checkbox"/> <input type="checkbox"/> <input type="checkbox"/> <input type="checkbox"/> <input type="checkbox"/> <input type="checkbox"/> <input type="checkbox"/>	119	<input type="checkbox"/> <input type="checkbox"/> <input type="checkbox"/> <input type="checkbox"/> <input type="checkbox"/> <input type="checkbox"/> <input type="checkbox"/> <input type="checkbox"/>	151	<input type="checkbox"/> <input type="checkbox"/> <input type="checkbox"/> <input type="checkbox"/> <input type="checkbox"/> <input type="checkbox"/> <input type="checkbox"/> <input type="checkbox"/>
24	<input type="checkbox"/> <input type="checkbox"/> <input type="checkbox"/> <input type="checkbox"/> <input type="checkbox"/> <input type="checkbox"/> <input type="checkbox"/> <input type="checkbox"/>	56	<input type="checkbox"/> <input type="checkbox"/> <input type="checkbox"/> <input type="checkbox"/> <input type="checkbox"/> <input type="checkbox"/> <input type="checkbox"/> <input type="checkbox"/>	88	<input type="checkbox"/> <input type="checkbox"/> <input type="checkbox"/> <input type="checkbox"/> <input type="checkbox"/> <input type="checkbox"/> <input type="checkbox"/> <input type="checkbox"/>	120	<input type="checkbox"/> <input type="checkbox"/> <input type="checkbox"/> <input type="checkbox"/> <input type="checkbox"/> <input type="checkbox"/> <input type="checkbox"/> <input type="checkbox"/>	152	<input type="checkbox"/> <input type="checkbox"/> <input type="checkbox"/> <input type="checkbox"/> <input type="checkbox"/> <input type="checkbox"/> <input type="checkbox"/> <input type="checkbox"/>
25	<input type="checkbox"/> <input type="checkbox"/> <input type="checkbox"/> <input type="checkbox"/> <input type="checkbox"/> <input type="checkbox"/> <input type="checkbox"/> <input type="checkbox"/>	57	<input type="checkbox"/> <input type="checkbox"/> <input type="checkbox"/> <input type="checkbox"/> <input type="checkbox"/> <input type="checkbox"/> <input type="checkbox"/> <input type="checkbox"/>	89	<input type="checkbox"/> <input type="checkbox"/> <input type="checkbox"/> <input type="checkbox"/> <input type="checkbox"/> <input type="checkbox"/> <input type="checkbox"/> <input type="checkbox"/>	121	<input type="checkbox"/> <input type="checkbox"/> <input type="checkbox"/> <input type="checkbox"/> <input type="checkbox"/> <input type="checkbox"/> <input type="checkbox"/> <input type="checkbox"/>	153	<input type="checkbox"/> <input type="checkbox"/> <input type="checkbox"/> <input type="checkbox"/> <input type="checkbox"/> <input type="checkbox"/> <input type="checkbox"/> <input type="checkbox"/>
26	<input type="checkbox"/> <input type="checkbox"/> <input type="checkbox"/> <input type="checkbox"/> <input type="checkbox"/> <input type="checkbox"/> <input type="checkbox"/> <input type="checkbox"/>	58	<input type="checkbox"/> <input type="checkbox"/> <input type="checkbox"/> <input type="checkbox"/> <input type="checkbox"/> <input type="checkbox"/> <input type="checkbox"/> <input type="checkbox"/>	90	<input type="checkbox"/> <input type="checkbox"/> <input type="checkbox"/> <input type="checkbox"/> <input type="checkbox"/> <input type="checkbox"/> <input type="checkbox"/> <input type="checkbox"/>	122	<input type="checkbox"/> <input type="checkbox"/> <input type="checkbox"/> <input type="checkbox"/> <input type="checkbox"/> <input type="checkbox"/> <input type="checkbox"/> <input type="checkbox"/>	154	<input type="checkbox"/> <input type="checkbox"/> <input type="checkbox"/> <input type="checkbox"/> <input type="checkbox"/> <input type="checkbox"/> <input type="checkbox"/> <input type="checkbox"/>
27	<input type="checkbox"/> <input type="checkbox"/> <input type="checkbox"/> <input type="checkbox"/> <input type="checkbox"/> <input type="checkbox"/> <input type="checkbox"/> <input type="checkbox"/>	59	<input type="checkbox"/> <input type="checkbox"/> <input type="checkbox"/> <input type="checkbox"/> <input type="checkbox"/> <input type="checkbox"/> <input type="checkbox"/> <input type="checkbox"/>	91	<input type="checkbox"/> <input type="checkbox"/> <input type="checkbox"/> <input type="checkbox"/> <input type="checkbox"/> <input type="checkbox"/> <input type="checkbox"/> <input type="checkbox"/>	123	<input type="checkbox"/> <input type="checkbox"/> <input type="checkbox"/> <input type="checkbox"/> <input type="checkbox"/> <input type="checkbox"/> <input type="checkbox"/> <input type="checkbox"/>	155	<input type="checkbox"/> <input type="checkbox"/> <input type="checkbox"/> <input type="checkbox"/> <input type="checkbox"/> <input type="checkbox"/> <input type="checkbox"/> <input type="checkbox"/>
28	<input type="checkbox"/> <input type="checkbox"/> <input type="checkbox"/> <input type="checkbox"/> <input type="checkbox"/> <input type="checkbox"/> <input type="checkbox"/> <input type="checkbox"/>	60	<input type="checkbox"/> <input type="checkbox"/> <input type="checkbox"/> <input type="checkbox"/> <input type="checkbox"/> <input type="checkbox"/> <input type="checkbox"/> <input type="checkbox"/>	92	<input type="checkbox"/> <input type="checkbox"/> <input type="checkbox"/> <input type="checkbox"/> <input type="checkbox"/> <input type="checkbox"/> <input type="checkbox"/> <input type="checkbox"/>	124	<input type="checkbox"/> <input type="checkbox"/> <input type="checkbox"/> <input type="checkbox"/> <input type="checkbox"/> <input type="checkbox"/> <input type="checkbox"/> <input type="checkbox"/>	156	<input type="checkbox"/> <input type="checkbox"/> <input type="checkbox"/> <input type="checkbox"/> <input type="checkbox"/> <input type="checkbox"/> <input type="checkbox"/> <input type="checkbox"/>
29	<input type="checkbox"/> <input type="checkbox"/> <input type="checkbox"/> <input type="checkbox"/> <input type="checkbox"/> <input type="checkbox"/> <input type="checkbox"/> <input type="checkbox"/>	61	<input type="checkbox"/> <input type="checkbox"/> <input type="checkbox"/> <input type="checkbox"/> <input type="checkbox"/> <input type="checkbox"/> <input type="checkbox"/> <input type="checkbox"/>	93	<input type="checkbox"/> <input type="checkbox"/> <input type="checkbox"/> <input type="checkbox"/> <input type="checkbox"/> <input type="checkbox"/> <input type="checkbox"/> <input type="checkbox"/>	125	<input type="checkbox"/> <input type="checkbox"/> <input type="checkbox"/> <input type="checkbox"/> <input type="checkbox"/> <input type="checkbox"/> <input type="checkbox"/> <input type="checkbox"/>	157	<input type="checkbox"/> <input type="checkbox"/> <input type="checkbox"/> <input type="checkbox"/> <input type="checkbox"/> <input type="checkbox"/> <input type="checkbox"/> <input type="checkbox"/>
30	<input type="checkbox"/> <input type="checkbox"/> <input type="checkbox"/> <input type="checkbox"/> <input type="checkbox"/> <input type="checkbox"/> <input type="checkbox"/> <input type="checkbox"/>	62	<input type="checkbox"/> <input type="checkbox"/> <input type="checkbox"/> <input type="checkbox"/> <input type="checkbox"/> <input type="checkbox"/> <input type="checkbox"/> <input type="checkbox"/>	94	<input type="checkbox"/> <input type="checkbox"/> <input type="checkbox"/> <input type="checkbox"/> <input type="checkbox"/> <input type="checkbox"/> <input type="checkbox"/> <input type="checkbox"/>	126	<input type="checkbox"/> <input type="checkbox"/> <input type="checkbox"/> <input type="checkbox"/> <input type="checkbox"/> <input type="checkbox"/> <input type="checkbox"/> <input type="checkbox"/>	158	<input type="checkbox"/> <input type="checkbox"/> <input type="checkbox"/> <input type="checkbox"/> <input type="checkbox"/> <input type="checkbox"/> <input type="checkbox"/> <input type="checkbox"/>
31	<input type="checkbox"/> <input type="checkbox"/> <input type="checkbox"/> <input type="checkbox"/> <input type="checkbox"/> <input type="checkbox"/> <input type="checkbox"/> <input type="checkbox"/>	63	<input type="checkbox"/> <input type="checkbox"/> <input type="checkbox"/> <input type="checkbox"/> <input type="checkbox"/> <input type="checkbox"/> <input type="checkbox"/> <input type="checkbox"/>	95	<input type="checkbox"/> <input type="checkbox"/> <input type="checkbox"/> <input type="checkbox"/> <input type="checkbox"/> <input type="checkbox"/> <input type="checkbox"/> <input type="checkbox"/>	127	<input type="checkbox"/> <input type="checkbox"/> <input type="checkbox"/> <input type="checkbox"/> <input type="checkbox"/> <input type="checkbox"/> <input type="checkbox"/> <input type="checkbox"/>	159	<input type="checkbox"/> <input type="checkbox"/> <input type="checkbox"/> <input type="checkbox"/> <input type="checkbox"/> <input type="checkbox"/> <input type="checkbox"/> <input type="checkbox"/>

Addr	Switch Settings	Addr	Switch Settings	Addr	Switch Settings
160	□□□□□□□□	200	□□□□□□□□	240	□□□□□□□□
161	□□□□□□□□	201	□□□□□□□□	241	□□□□□□□□
162	□□□□□□□□	202	□□□□□□□□	242	□□□□□□□□
163	□□□□□□□□	203	□□□□□□□□	243	□□□□□□□□
164	□□□□□□□□	204	□□□□□□□□	244	□□□□□□□□
165	□□□□□□□□	205	□□□□□□□□	245	□□□□□□□□
166	□□□□□□□□	206	□□□□□□□□	246	□□□□□□□□
167	□□□□□□□□	207	□□□□□□□□	247	□□□□□□□□
168	□□□□□□□□	208	□□□□□□□□	248	□□□□□□□□
169	□□□□□□□□	209	□□□□□□□□	249	□□□□□□□□
170	□□□□□□□□	210	□□□□□□□□	250	□□□□□□□□
171	□□□□□□□□	211	□□□□□□□□	251	□□□□□□□□
172	□□□□□□□□	212	□□□□□□□□	252	□□□□□□□□
173	□□□□□□□□	213	□□□□□□□□	253	□□□□□□□□
174	□□□□□□□□	214	□□□□□□□□	254	□□□□□□□□
175	□□□□□□□□	215	□□□□□□□□	255	□□□□□□□□
176	□□□□□□□□	216	□□□□□□□□		
177	□□□□□□□□	217	□□□□□□□□		
178	□□□□□□□□	218	□□□□□□□□		
179	□□□□□□□□	219	□□□□□□□□		
180	□□□□□□□□	220	□□□□□□□□		
181	□□□□□□□□	221	□□□□□□□□		
182	□□□□□□□□	222	□□□□□□□□		
183	□□□□□□□□	223	□□□□□□□□		
184	□□□□□□□□	224	□□□□□□□□		
185	□□□□□□□□	225	□□□□□□□□		
186	□□□□□□□□	226	□□□□□□□□		
187	□□□□□□□□	227	□□□□□□□□		
188	□□□□□□□□	228	□□□□□□□□		
189	□□□□□□□□	229	□□□□□□□□		
190	□□□□□□□□	230	□□□□□□□□		
191	□□□□□□□□	231	□□□□□□□□		
192	□□□□□□□□	232	□□□□□□□□		
193	□□□□□□□□	233	□□□□□□□□		
194	□□□□□□□□	234	□□□□□□□□		
195	□□□□□□□□	235	□□□□□□□□		
196	□□□□□□□□	236	□□□□□□□□		
197	□□□□□□□□	237	□□□□□□□□		
198	□□□□□□□□	238	□□□□□□□□		
199	□□□□□□□□	239	□□□□□□□□		

DMX Addresses

DMX addresses use all eight of the DIP switches on S1 plus one switch on S2. Make sure you're looking at the dimmer with the screw wiring connectors at the top.

Key
 Switch up
 Switch down

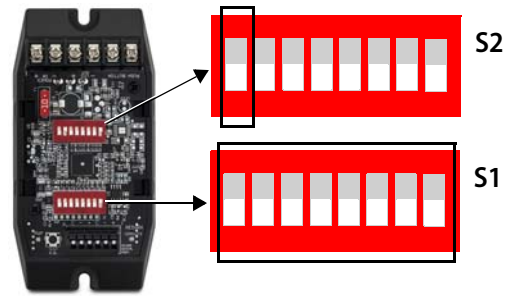

Addr	Switch Settings	Addr	Switch Settings	Addr	Switch Settings	Addr	Switch Settings	Addr	Switch Settings
1	<input type="checkbox"/> <input type="checkbox"/> <input type="checkbox"/> <input type="checkbox"/> <input type="checkbox"/> <input type="checkbox"/> <input type="checkbox"/> <input type="checkbox"/> <input type="checkbox"/>	33	<input type="checkbox"/> <input type="checkbox"/> <input type="checkbox"/> <input type="checkbox"/> <input type="checkbox"/> <input type="checkbox"/> <input type="checkbox"/> <input type="checkbox"/> <input type="checkbox"/>	65	<input type="checkbox"/> <input type="checkbox"/> <input type="checkbox"/> <input type="checkbox"/> <input type="checkbox"/> <input type="checkbox"/> <input type="checkbox"/> <input type="checkbox"/> <input type="checkbox"/>	97	<input type="checkbox"/> <input type="checkbox"/> <input type="checkbox"/> <input type="checkbox"/> <input type="checkbox"/> <input type="checkbox"/> <input type="checkbox"/> <input type="checkbox"/> <input type="checkbox"/>	129	<input type="checkbox"/> <input type="checkbox"/> <input type="checkbox"/> <input type="checkbox"/> <input type="checkbox"/> <input type="checkbox"/> <input type="checkbox"/> <input type="checkbox"/> <input type="checkbox"/>
2	<input type="checkbox"/> <input type="checkbox"/> <input type="checkbox"/> <input type="checkbox"/> <input type="checkbox"/> <input type="checkbox"/> <input type="checkbox"/> <input type="checkbox"/> <input type="checkbox"/>	34	<input type="checkbox"/> <input type="checkbox"/> <input type="checkbox"/> <input type="checkbox"/> <input type="checkbox"/> <input type="checkbox"/> <input type="checkbox"/> <input type="checkbox"/> <input type="checkbox"/>	66	<input type="checkbox"/> <input type="checkbox"/> <input type="checkbox"/> <input type="checkbox"/> <input type="checkbox"/> <input type="checkbox"/> <input type="checkbox"/> <input type="checkbox"/> <input type="checkbox"/>	98	<input type="checkbox"/> <input type="checkbox"/> <input type="checkbox"/> <input type="checkbox"/> <input type="checkbox"/> <input type="checkbox"/> <input type="checkbox"/> <input type="checkbox"/> <input type="checkbox"/>	130	<input type="checkbox"/> <input type="checkbox"/> <input type="checkbox"/> <input type="checkbox"/> <input type="checkbox"/> <input type="checkbox"/> <input type="checkbox"/> <input type="checkbox"/> <input type="checkbox"/>
3	<input type="checkbox"/> <input type="checkbox"/> <input type="checkbox"/> <input type="checkbox"/> <input type="checkbox"/> <input type="checkbox"/> <input type="checkbox"/> <input type="checkbox"/> <input type="checkbox"/>	35	<input type="checkbox"/> <input type="checkbox"/> <input type="checkbox"/> <input type="checkbox"/> <input type="checkbox"/> <input type="checkbox"/> <input type="checkbox"/> <input type="checkbox"/> <input type="checkbox"/>	67	<input type="checkbox"/> <input type="checkbox"/> <input type="checkbox"/> <input type="checkbox"/> <input type="checkbox"/> <input type="checkbox"/> <input type="checkbox"/> <input type="checkbox"/> <input type="checkbox"/>	99	<input type="checkbox"/> <input type="checkbox"/> <input type="checkbox"/> <input type="checkbox"/> <input type="checkbox"/> <input type="checkbox"/> <input type="checkbox"/> <input type="checkbox"/> <input type="checkbox"/>	131	<input type="checkbox"/> <input type="checkbox"/> <input type="checkbox"/> <input type="checkbox"/> <input type="checkbox"/> <input type="checkbox"/> <input type="checkbox"/> <input type="checkbox"/> <input type="checkbox"/>
4	<input type="checkbox"/> <input type="checkbox"/> <input type="checkbox"/> <input type="checkbox"/> <input type="checkbox"/> <input type="checkbox"/> <input type="checkbox"/> <input type="checkbox"/> <input type="checkbox"/>	36	<input type="checkbox"/> <input type="checkbox"/> <input type="checkbox"/> <input type="checkbox"/> <input type="checkbox"/> <input type="checkbox"/> <input type="checkbox"/> <input type="checkbox"/> <input type="checkbox"/>	68	<input type="checkbox"/> <input type="checkbox"/> <input type="checkbox"/> <input type="checkbox"/> <input type="checkbox"/> <input type="checkbox"/> <input type="checkbox"/> <input type="checkbox"/> <input type="checkbox"/>	100	<input type="checkbox"/> <input type="checkbox"/> <input type="checkbox"/> <input type="checkbox"/> <input type="checkbox"/> <input type="checkbox"/> <input type="checkbox"/> <input type="checkbox"/> <input type="checkbox"/>	132	<input type="checkbox"/> <input type="checkbox"/> <input type="checkbox"/> <input type="checkbox"/> <input type="checkbox"/> <input type="checkbox"/> <input type="checkbox"/> <input type="checkbox"/> <input type="checkbox"/>
5	<input type="checkbox"/> <input type="checkbox"/> <input type="checkbox"/> <input type="checkbox"/> <input type="checkbox"/> <input type="checkbox"/> <input type="checkbox"/> <input type="checkbox"/> <input type="checkbox"/>	37	<input type="checkbox"/> <input type="checkbox"/> <input type="checkbox"/> <input type="checkbox"/> <input type="checkbox"/> <input type="checkbox"/> <input type="checkbox"/> <input type="checkbox"/> <input type="checkbox"/>	69	<input type="checkbox"/> <input type="checkbox"/> <input type="checkbox"/> <input type="checkbox"/> <input type="checkbox"/> <input type="checkbox"/> <input type="checkbox"/> <input type="checkbox"/> <input type="checkbox"/>	101	<input type="checkbox"/> <input type="checkbox"/> <input type="checkbox"/> <input type="checkbox"/> <input type="checkbox"/> <input type="checkbox"/> <input type="checkbox"/> <input type="checkbox"/> <input type="checkbox"/>	133	<input type="checkbox"/> <input type="checkbox"/> <input type="checkbox"/> <input type="checkbox"/> <input type="checkbox"/> <input type="checkbox"/> <input type="checkbox"/> <input type="checkbox"/> <input type="checkbox"/>
6	<input type="checkbox"/> <input type="checkbox"/> <input type="checkbox"/> <input type="checkbox"/> <input type="checkbox"/> <input type="checkbox"/> <input type="checkbox"/> <input type="checkbox"/> <input type="checkbox"/>	38	<input type="checkbox"/> <input type="checkbox"/> <input type="checkbox"/> <input type="checkbox"/> <input type="checkbox"/> <input type="checkbox"/> <input type="checkbox"/> <input type="checkbox"/> <input type="checkbox"/>	70	<input type="checkbox"/> <input type="checkbox"/> <input type="checkbox"/> <input type="checkbox"/> <input type="checkbox"/> <input type="checkbox"/> <input type="checkbox"/> <input type="checkbox"/> <input type="checkbox"/>	102	<input type="checkbox"/> <input type="checkbox"/> <input type="checkbox"/> <input type="checkbox"/> <input type="checkbox"/> <input type="checkbox"/> <input type="checkbox"/> <input type="checkbox"/> <input type="checkbox"/>	134	<input type="checkbox"/> <input type="checkbox"/> <input type="checkbox"/> <input type="checkbox"/> <input type="checkbox"/> <input type="checkbox"/> <input type="checkbox"/> <input type="checkbox"/> <input type="checkbox"/>
7	<input type="checkbox"/> <input type="checkbox"/> <input type="checkbox"/> <input type="checkbox"/> <input type="checkbox"/> <input type="checkbox"/> <input type="checkbox"/> <input type="checkbox"/> <input type="checkbox"/>	39	<input type="checkbox"/> <input type="checkbox"/> <input type="checkbox"/> <input type="checkbox"/> <input type="checkbox"/> <input type="checkbox"/> <input type="checkbox"/> <input type="checkbox"/> <input type="checkbox"/>	71	<input type="checkbox"/> <input type="checkbox"/> <input type="checkbox"/> <input type="checkbox"/> <input type="checkbox"/> <input type="checkbox"/> <input type="checkbox"/> <input type="checkbox"/> <input type="checkbox"/>	103	<input type="checkbox"/> <input type="checkbox"/> <input type="checkbox"/> <input type="checkbox"/> <input type="checkbox"/> <input type="checkbox"/> <input type="checkbox"/> <input type="checkbox"/> <input type="checkbox"/>	135	<input type="checkbox"/> <input type="checkbox"/> <input type="checkbox"/> <input type="checkbox"/> <input type="checkbox"/> <input type="checkbox"/> <input type="checkbox"/> <input type="checkbox"/> <input type="checkbox"/>
8	<input type="checkbox"/> <input type="checkbox"/> <input type="checkbox"/> <input type="checkbox"/> <input type="checkbox"/> <input type="checkbox"/> <input type="checkbox"/> <input type="checkbox"/> <input type="checkbox"/>	40	<input type="checkbox"/> <input type="checkbox"/> <input type="checkbox"/> <input type="checkbox"/> <input type="checkbox"/> <input type="checkbox"/> <input type="checkbox"/> <input type="checkbox"/> <input type="checkbox"/>	72	<input type="checkbox"/> <input type="checkbox"/> <input type="checkbox"/> <input type="checkbox"/> <input type="checkbox"/> <input type="checkbox"/> <input type="checkbox"/> <input type="checkbox"/> <input type="checkbox"/>	104	<input type="checkbox"/> <input type="checkbox"/> <input type="checkbox"/> <input type="checkbox"/> <input type="checkbox"/> <input type="checkbox"/> <input type="checkbox"/> <input type="checkbox"/> <input type="checkbox"/>	136	<input type="checkbox"/> <input type="checkbox"/> <input type="checkbox"/> <input type="checkbox"/> <input type="checkbox"/> <input type="checkbox"/> <input type="checkbox"/> <input type="checkbox"/> <input type="checkbox"/>
9	<input type="checkbox"/> <input type="checkbox"/> <input type="checkbox"/> <input type="checkbox"/> <input type="checkbox"/> <input type="checkbox"/> <input type="checkbox"/> <input type="checkbox"/> <input type="checkbox"/>	41	<input type="checkbox"/> <input type="checkbox"/> <input type="checkbox"/> <input type="checkbox"/> <input type="checkbox"/> <input type="checkbox"/> <input type="checkbox"/> <input type="checkbox"/> <input type="checkbox"/>	73	<input type="checkbox"/> <input type="checkbox"/> <input type="checkbox"/> <input type="checkbox"/> <input type="checkbox"/> <input type="checkbox"/> <input type="checkbox"/> <input type="checkbox"/> <input type="checkbox"/>	105	<input type="checkbox"/> <input type="checkbox"/> <input type="checkbox"/> <input type="checkbox"/> <input type="checkbox"/> <input type="checkbox"/> <input type="checkbox"/> <input type="checkbox"/> <input type="checkbox"/>	137	<input type="checkbox"/> <input type="checkbox"/> <input type="checkbox"/> <input type="checkbox"/> <input type="checkbox"/> <input type="checkbox"/> <input type="checkbox"/> <input type="checkbox"/> <input type="checkbox"/>
10	<input type="checkbox"/> <input type="checkbox"/> <input type="checkbox"/> <input type="checkbox"/> <input type="checkbox"/> <input type="checkbox"/> <input type="checkbox"/> <input type="checkbox"/> <input type="checkbox"/>	42	<input type="checkbox"/> <input type="checkbox"/> <input type="checkbox"/> <input type="checkbox"/> <input type="checkbox"/> <input type="checkbox"/> <input type="checkbox"/> <input type="checkbox"/> <input type="checkbox"/>	74	<input type="checkbox"/> <input type="checkbox"/> <input type="checkbox"/> <input type="checkbox"/> <input type="checkbox"/> <input type="checkbox"/> <input type="checkbox"/> <input type="checkbox"/> <input type="checkbox"/>	106	<input type="checkbox"/> <input type="checkbox"/> <input type="checkbox"/> <input type="checkbox"/> <input type="checkbox"/> <input type="checkbox"/> <input type="checkbox"/> <input type="checkbox"/> <input type="checkbox"/>	138	<input type="checkbox"/> <input type="checkbox"/> <input type="checkbox"/> <input type="checkbox"/> <input type="checkbox"/> <input type="checkbox"/> <input type="checkbox"/> <input type="checkbox"/> <input type="checkbox"/>
11	<input type="checkbox"/> <input type="checkbox"/> <input type="checkbox"/> <input type="checkbox"/> <input type="checkbox"/> <input type="checkbox"/> <input type="checkbox"/> <input type="checkbox"/> <input type="checkbox"/>	43	<input type="checkbox"/> <input type="checkbox"/> <input type="checkbox"/> <input type="checkbox"/> <input type="checkbox"/> <input type="checkbox"/> <input type="checkbox"/> <input type="checkbox"/> <input type="checkbox"/>	75	<input type="checkbox"/> <input type="checkbox"/> <input type="checkbox"/> <input type="checkbox"/> <input type="checkbox"/> <input type="checkbox"/> <input type="checkbox"/> <input type="checkbox"/> <input type="checkbox"/>	107	<input type="checkbox"/> <input type="checkbox"/> <input type="checkbox"/> <input type="checkbox"/> <input type="checkbox"/> <input type="checkbox"/> <input type="checkbox"/> <input type="checkbox"/> <input type="checkbox"/>	139	<input type="checkbox"/> <input type="checkbox"/> <input type="checkbox"/> <input type="checkbox"/> <input type="checkbox"/> <input type="checkbox"/> <input type="checkbox"/> <input type="checkbox"/> <input type="checkbox"/>
12	<input type="checkbox"/> <input type="checkbox"/> <input type="checkbox"/> <input type="checkbox"/> <input type="checkbox"/> <input type="checkbox"/> <input type="checkbox"/> <input type="checkbox"/> <input type="checkbox"/>	44	<input type="checkbox"/> <input type="checkbox"/> <input type="checkbox"/> <input type="checkbox"/> <input type="checkbox"/> <input type="checkbox"/> <input type="checkbox"/> <input type="checkbox"/> <input type="checkbox"/>	76	<input type="checkbox"/> <input type="checkbox"/> <input type="checkbox"/> <input type="checkbox"/> <input type="checkbox"/> <input type="checkbox"/> <input type="checkbox"/> <input type="checkbox"/> <input type="checkbox"/>	108	<input type="checkbox"/> <input type="checkbox"/> <input type="checkbox"/> <input type="checkbox"/> <input type="checkbox"/> <input type="checkbox"/> <input type="checkbox"/> <input type="checkbox"/> <input type="checkbox"/>	140	<input type="checkbox"/> <input type="checkbox"/> <input type="checkbox"/> <input type="checkbox"/> <input type="checkbox"/> <input type="checkbox"/> <input type="checkbox"/> <input type="checkbox"/> <input type="checkbox"/>
13	<input type="checkbox"/> <input type="checkbox"/> <input type="checkbox"/> <input type="checkbox"/> <input type="checkbox"/> <input type="checkbox"/> <input type="checkbox"/> <input type="checkbox"/> <input type="checkbox"/>	45	<input type="checkbox"/> <input type="checkbox"/> <input type="checkbox"/> <input type="checkbox"/> <input type="checkbox"/> <input type="checkbox"/> <input type="checkbox"/> <input type="checkbox"/> <input type="checkbox"/>	77	<input type="checkbox"/> <input type="checkbox"/> <input type="checkbox"/> <input type="checkbox"/> <input type="checkbox"/> <input type="checkbox"/> <input type="checkbox"/> <input type="checkbox"/> <input type="checkbox"/>	109	<input type="checkbox"/> <input type="checkbox"/> <input type="checkbox"/> <input type="checkbox"/> <input type="checkbox"/> <input type="checkbox"/> <input type="checkbox"/> <input type="checkbox"/> <input type="checkbox"/>	141	<input type="checkbox"/> <input type="checkbox"/> <input type="checkbox"/> <input type="checkbox"/> <input type="checkbox"/> <input type="checkbox"/> <input type="checkbox"/> <input type="checkbox"/> <input type="checkbox"/>
14	<input type="checkbox"/> <input type="checkbox"/> <input type="checkbox"/> <input type="checkbox"/> <input type="checkbox"/> <input type="checkbox"/> <input type="checkbox"/> <input type="checkbox"/> <input type="checkbox"/>	46	<input type="checkbox"/> <input type="checkbox"/> <input type="checkbox"/> <input type="checkbox"/> <input type="checkbox"/> <input type="checkbox"/> <input type="checkbox"/> <input type="checkbox"/> <input type="checkbox"/>	78	<input type="checkbox"/> <input type="checkbox"/> <input type="checkbox"/> <input type="checkbox"/> <input type="checkbox"/> <input type="checkbox"/> <input type="checkbox"/> <input type="checkbox"/> <input type="checkbox"/>	110	<input type="checkbox"/> <input type="checkbox"/> <input type="checkbox"/> <input type="checkbox"/> <input type="checkbox"/> <input type="checkbox"/> <input type="checkbox"/> <input type="checkbox"/> <input type="checkbox"/>	142	<input type="checkbox"/> <input type="checkbox"/> <input type="checkbox"/> <input type="checkbox"/> <input type="checkbox"/> <input type="checkbox"/> <input type="checkbox"/> <input type="checkbox"/> <input type="checkbox"/>
15	<input type="checkbox"/> <input type="checkbox"/> <input type="checkbox"/> <input type="checkbox"/> <input type="checkbox"/> <input type="checkbox"/> <input type="checkbox"/> <input type="checkbox"/> <input type="checkbox"/>	47	<input type="checkbox"/> <input type="checkbox"/> <input type="checkbox"/> <input type="checkbox"/> <input type="checkbox"/> <input type="checkbox"/> <input type="checkbox"/> <input type="checkbox"/> <input type="checkbox"/>	79	<input type="checkbox"/> <input type="checkbox"/> <input type="checkbox"/> <input type="checkbox"/> <input type="checkbox"/> <input type="checkbox"/> <input type="checkbox"/> <input type="checkbox"/> <input type="checkbox"/>	111	<input type="checkbox"/> <input type="checkbox"/> <input type="checkbox"/> <input type="checkbox"/> <input type="checkbox"/> <input type="checkbox"/> <input type="checkbox"/> <input type="checkbox"/> <input type="checkbox"/>	143	<input type="checkbox"/> <input type="checkbox"/> <input type="checkbox"/> <input type="checkbox"/> <input type="checkbox"/> <input type="checkbox"/> <input type="checkbox"/> <input type="checkbox"/> <input type="checkbox"/>
16	<input type="checkbox"/> <input type="checkbox"/> <input type="checkbox"/> <input type="checkbox"/> <input type="checkbox"/> <input type="checkbox"/> <input type="checkbox"/> <input type="checkbox"/> <input type="checkbox"/>	48	<input type="checkbox"/> <input type="checkbox"/> <input type="checkbox"/> <input type="checkbox"/> <input type="checkbox"/> <input type="checkbox"/> <input type="checkbox"/> <input type="checkbox"/> <input type="checkbox"/>	80	<input type="checkbox"/> <input type="checkbox"/> <input type="checkbox"/> <input type="checkbox"/> <input type="checkbox"/> <input type="checkbox"/> <input type="checkbox"/> <input type="checkbox"/> <input type="checkbox"/>	112	<input type="checkbox"/> <input type="checkbox"/> <input type="checkbox"/> <input type="checkbox"/> <input type="checkbox"/> <input type="checkbox"/> <input type="checkbox"/> <input type="checkbox"/> <input type="checkbox"/>	144	<input type="checkbox"/> <input type="checkbox"/> <input type="checkbox"/> <input type="checkbox"/> <input type="checkbox"/> <input type="checkbox"/> <input type="checkbox"/> <input type="checkbox"/> <input type="checkbox"/>
17	<input type="checkbox"/> <input type="checkbox"/> <input type="checkbox"/> <input type="checkbox"/> <input type="checkbox"/> <input type="checkbox"/> <input type="checkbox"/> <input type="checkbox"/> <input type="checkbox"/>	49	<input type="checkbox"/> <input type="checkbox"/> <input type="checkbox"/> <input type="checkbox"/> <input type="checkbox"/> <input type="checkbox"/> <input type="checkbox"/> <input type="checkbox"/> <input type="checkbox"/>	81	<input type="checkbox"/> <input type="checkbox"/> <input type="checkbox"/> <input type="checkbox"/> <input type="checkbox"/> <input type="checkbox"/> <input type="checkbox"/> <input type="checkbox"/> <input type="checkbox"/>	113	<input type="checkbox"/> <input type="checkbox"/> <input type="checkbox"/> <input type="checkbox"/> <input type="checkbox"/> <input type="checkbox"/> <input type="checkbox"/> <input type="checkbox"/> <input type="checkbox"/>	145	<input type="checkbox"/> <input type="checkbox"/> <input type="checkbox"/> <input type="checkbox"/> <input type="checkbox"/> <input type="checkbox"/> <input type="checkbox"/> <input type="checkbox"/> <input type="checkbox"/>
18	<input type="checkbox"/> <input type="checkbox"/> <input type="checkbox"/> <input type="checkbox"/> <input type="checkbox"/> <input type="checkbox"/> <input type="checkbox"/> <input type="checkbox"/> <input type="checkbox"/>	50	<input type="checkbox"/> <input type="checkbox"/> <input type="checkbox"/> <input type="checkbox"/> <input type="checkbox"/> <input type="checkbox"/> <input type="checkbox"/> <input type="checkbox"/> <input type="checkbox"/>	82	<input type="checkbox"/> <input type="checkbox"/> <input type="checkbox"/> <input type="checkbox"/> <input type="checkbox"/> <input type="checkbox"/> <input type="checkbox"/> <input type="checkbox"/> <input type="checkbox"/>	114	<input type="checkbox"/> <input type="checkbox"/> <input type="checkbox"/> <input type="checkbox"/> <input type="checkbox"/> <input type="checkbox"/> <input type="checkbox"/> <input type="checkbox"/> <input type="checkbox"/>	146	<input type="checkbox"/> <input type="checkbox"/> <input type="checkbox"/> <input type="checkbox"/> <input type="checkbox"/> <input type="checkbox"/> <input type="checkbox"/> <input type="checkbox"/> <input type="checkbox"/>
19	<input type="checkbox"/> <input type="checkbox"/> <input type="checkbox"/> <input type="checkbox"/> <input type="checkbox"/> <input type="checkbox"/> <input type="checkbox"/> <input type="checkbox"/> <input type="checkbox"/>	51	<input type="checkbox"/> <input type="checkbox"/> <input type="checkbox"/> <input type="checkbox"/> <input type="checkbox"/> <input type="checkbox"/> <input type="checkbox"/> <input type="checkbox"/> <input type="checkbox"/>	83	<input type="checkbox"/> <input type="checkbox"/> <input type="checkbox"/> <input type="checkbox"/> <input type="checkbox"/> <input type="checkbox"/> <input type="checkbox"/> <input type="checkbox"/> <input type="checkbox"/>	115	<input type="checkbox"/> <input type="checkbox"/> <input type="checkbox"/> <input type="checkbox"/> <input type="checkbox"/> <input type="checkbox"/> <input type="checkbox"/> <input type="checkbox"/> <input type="checkbox"/>	147	<input type="checkbox"/> <input type="checkbox"/> <input type="checkbox"/> <input type="checkbox"/> <input type="checkbox"/> <input type="checkbox"/> <input type="checkbox"/> <input type="checkbox"/> <input type="checkbox"/>
20	<input type="checkbox"/> <input type="checkbox"/> <input type="checkbox"/> <input type="checkbox"/> <input type="checkbox"/> <input type="checkbox"/> <input type="checkbox"/> <input type="checkbox"/> <input type="checkbox"/>	52	<input type="checkbox"/> <input type="checkbox"/> <input type="checkbox"/> <input type="checkbox"/> <input type="checkbox"/> <input type="checkbox"/> <input type="checkbox"/> <input type="checkbox"/> <input type="checkbox"/>	84	<input type="checkbox"/> <input type="checkbox"/> <input type="checkbox"/> <input type="checkbox"/> <input type="checkbox"/> <input type="checkbox"/> <input type="checkbox"/> <input type="checkbox"/> <input type="checkbox"/>	116	<input type="checkbox"/> <input type="checkbox"/> <input type="checkbox"/> <input type="checkbox"/> <input type="checkbox"/> <input type="checkbox"/> <input type="checkbox"/> <input type="checkbox"/> <input type="checkbox"/>	148	<input type="checkbox"/> <input type="checkbox"/> <input type="checkbox"/> <input type="checkbox"/> <input type="checkbox"/> <input type="checkbox"/> <input type="checkbox"/> <input type="checkbox"/> <input type="checkbox"/>
21	<input type="checkbox"/> <input type="checkbox"/> <input type="checkbox"/> <input type="checkbox"/> <input type="checkbox"/> <input type="checkbox"/> <input type="checkbox"/> <input type="checkbox"/> <input type="checkbox"/>	53	<input type="checkbox"/> <input type="checkbox"/> <input type="checkbox"/> <input type="checkbox"/> <input type="checkbox"/> <input type="checkbox"/> <input type="checkbox"/> <input type="checkbox"/> <input type="checkbox"/>	85	<input type="checkbox"/> <input type="checkbox"/> <input type="checkbox"/> <input type="checkbox"/> <input type="checkbox"/> <input type="checkbox"/> <input type="checkbox"/> <input type="checkbox"/> <input type="checkbox"/>	117	<input type="checkbox"/> <input type="checkbox"/> <input type="checkbox"/> <input type="checkbox"/> <input type="checkbox"/> <input type="checkbox"/> <input type="checkbox"/> <input type="checkbox"/> <input type="checkbox"/>	149	<input type="checkbox"/> <input type="checkbox"/> <input type="checkbox"/> <input type="checkbox"/> <input type="checkbox"/> <input type="checkbox"/> <input type="checkbox"/> <input type="checkbox"/> <input type="checkbox"/>
22	<input type="checkbox"/> <input type="checkbox"/> <input type="checkbox"/> <input type="checkbox"/> <input type="checkbox"/> <input type="checkbox"/> <input type="checkbox"/> <input type="checkbox"/> <input type="checkbox"/>	54	<input type="checkbox"/> <input type="checkbox"/> <input type="checkbox"/> <input type="checkbox"/> <input type="checkbox"/> <input type="checkbox"/> <input type="checkbox"/> <input type="checkbox"/> <input type="checkbox"/>	86	<input type="checkbox"/> <input type="checkbox"/> <input type="checkbox"/> <input type="checkbox"/> <input type="checkbox"/> <input type="checkbox"/> <input type="checkbox"/> <input type="checkbox"/> <input type="checkbox"/>	118	<input type="checkbox"/> <input type="checkbox"/> <input type="checkbox"/> <input type="checkbox"/> <input type="checkbox"/> <input type="checkbox"/> <input type="checkbox"/> <input type="checkbox"/> <input type="checkbox"/>	150	<input type="checkbox"/> <input type="checkbox"/> <input type="checkbox"/> <input type="checkbox"/> <input type="checkbox"/> <input type="checkbox"/> <input type="checkbox"/> <input type="checkbox"/> <input type="checkbox"/>
23	<input type="checkbox"/> <input type="checkbox"/> <input type="checkbox"/> <input type="checkbox"/> <input type="checkbox"/> <input type="checkbox"/> <input type="checkbox"/> <input type="checkbox"/> <input type="checkbox"/>	55	<input type="checkbox"/> <input type="checkbox"/> <input type="checkbox"/> <input type="checkbox"/> <input type="checkbox"/> <input type="checkbox"/> <input type="checkbox"/> <input type="checkbox"/> <input type="checkbox"/>	87	<input type="checkbox"/> <input type="checkbox"/> <input type="checkbox"/> <input type="checkbox"/> <input type="checkbox"/> <input type="checkbox"/> <input type="checkbox"/> <input type="checkbox"/> <input type="checkbox"/>	119	<input type="checkbox"/> <input type="checkbox"/> <input type="checkbox"/> <input type="checkbox"/> <input type="checkbox"/> <input type="checkbox"/> <input type="checkbox"/> <input type="checkbox"/> <input type="checkbox"/>	151	<input type="checkbox"/> <input type="checkbox"/> <input type="checkbox"/> <input type="checkbox"/> <input type="checkbox"/> <input type="checkbox"/> <input type="checkbox"/> <input type="checkbox"/> <input type="checkbox"/>
24	<input type="checkbox"/> <input type="checkbox"/> <input type="checkbox"/> <input type="checkbox"/> <input type="checkbox"/> <input type="checkbox"/> <input type="checkbox"/> <input type="checkbox"/> <input type="checkbox"/>	56	<input type="checkbox"/> <input type="checkbox"/> <input type="checkbox"/> <input type="checkbox"/> <input type="checkbox"/> <input type="checkbox"/> <input type="checkbox"/> <input type="checkbox"/> <input type="checkbox"/>	88	<input type="checkbox"/> <input type="checkbox"/> <input type="checkbox"/> <input type="checkbox"/> <input type="checkbox"/> <input type="checkbox"/> <input type="checkbox"/> <input type="checkbox"/> <input type="checkbox"/>	120	<input type="checkbox"/> <input type="checkbox"/> <input type="checkbox"/> <input type="checkbox"/> <input type="checkbox"/> <input type="checkbox"/> <input type="checkbox"/> <input type="checkbox"/> <input type="checkbox"/>	152	<input type="checkbox"/> <input type="checkbox"/> <input type="checkbox"/> <input type="checkbox"/> <input type="checkbox"/> <input type="checkbox"/> <input type="checkbox"/> <input type="checkbox"/> <input type="checkbox"/>
25	<input type="checkbox"/> <input type="checkbox"/> <input type="checkbox"/> <input type="checkbox"/> <input type="checkbox"/> <input type="checkbox"/> <input type="checkbox"/> <input type="checkbox"/> <input type="checkbox"/>	57	<input type="checkbox"/> <input type="checkbox"/> <input type="checkbox"/> <input type="checkbox"/> <input type="checkbox"/> <input type="checkbox"/> <input type="checkbox"/> <input type="checkbox"/> <input type="checkbox"/>	89	<input type="checkbox"/> <input type="checkbox"/> <input type="checkbox"/> <input type="checkbox"/> <input type="checkbox"/> <input type="checkbox"/> <input type="checkbox"/> <input type="checkbox"/> <input type="checkbox"/>	121	<input type="checkbox"/> <input type="checkbox"/> <input type="checkbox"/> <input type="checkbox"/> <input type="checkbox"/> <input type="checkbox"/> <input type="checkbox"/> <input type="checkbox"/> <input type="checkbox"/>	153	<input type="checkbox"/> <input type="checkbox"/> <input type="checkbox"/> <input type="checkbox"/> <input type="checkbox"/> <input type="checkbox"/> <input type="checkbox"/> <input type="checkbox"/> <input type="checkbox"/>
26	<input type="checkbox"/> <input type="checkbox"/> <input type="checkbox"/> <input type="checkbox"/> <input type="checkbox"/> <input type="checkbox"/> <input type="checkbox"/> <input type="checkbox"/> <input type="checkbox"/>	58	<input type="checkbox"/> <input type="checkbox"/> <input type="checkbox"/> <input type="checkbox"/> <input type="checkbox"/> <input type="checkbox"/> <input type="checkbox"/> <input type="checkbox"/> <input type="checkbox"/>	90	<input type="checkbox"/> <input type="checkbox"/> <input type="checkbox"/> <input type="checkbox"/> <input type="checkbox"/> <input type="checkbox"/> <input type="checkbox"/> <input type="checkbox"/> <input type="checkbox"/>	122	<input type="checkbox"/> <input type="checkbox"/> <input type="checkbox"/> <input type="checkbox"/> <input type="checkbox"/> <input type="checkbox"/> <input type="checkbox"/> <input type="checkbox"/> <input type="checkbox"/>	154	<input type="checkbox"/> <input type="checkbox"/> <input type="checkbox"/> <input type="checkbox"/> <input type="checkbox"/> <input type="checkbox"/> <input type="checkbox"/> <input type="checkbox"/> <input type="checkbox"/>
27	<input type="checkbox"/> <input type="checkbox"/> <input type="checkbox"/> <input type="checkbox"/> <input type="checkbox"/> <input type="checkbox"/> <input type="checkbox"/> <input type="checkbox"/> <input type="checkbox"/>	59	<input type="checkbox"/> <input type="checkbox"/> <input type="checkbox"/> <input type="checkbox"/> <input type="checkbox"/> <input type="checkbox"/> <input type="checkbox"/> <input type="checkbox"/> <input type="checkbox"/>	91	<input type="checkbox"/> <input type="checkbox"/> <input type="checkbox"/> <input type="checkbox"/> <input type="checkbox"/> <input type="checkbox"/> <input type="checkbox"/> <input type="checkbox"/> <input type="checkbox"/>	123	<input type="checkbox"/> <input type="checkbox"/> <input type="checkbox"/> <input type="checkbox"/> <input type="checkbox"/> <input type="checkbox"/> <input type="checkbox"/> <input type="checkbox"/> <input type="checkbox"/>	155	<input type="checkbox"/> <input type="checkbox"/> <input type="checkbox"/> <input type="checkbox"/> <input type="checkbox"/> <input type="checkbox"/> <input type="checkbox"/> <input type="checkbox"/> <input type="checkbox"/>
28	<input type="checkbox"/> <input type="checkbox"/> <input type="checkbox"/> <input type="checkbox"/> <input type="checkbox"/> <input type="checkbox"/> <input type="checkbox"/> <input type="checkbox"/> <input type="checkbox"/>	60	<input type="checkbox"/> <input type="checkbox"/> <input type="checkbox"/> <input type="checkbox"/> <input type="checkbox"/> <input type="checkbox"/> <input type="checkbox"/> <input type="checkbox"/> <input type="checkbox"/>	92	<input type="checkbox"/> <input type="checkbox"/> <input type="checkbox"/> <input type="checkbox"/> <input type="checkbox"/> <input type="checkbox"/> <input type="checkbox"/> <input type="checkbox"/> <input type="checkbox"/>	124	<input type="checkbox"/> <input type="checkbox"/> <input type="checkbox"/> <input type="checkbox"/> <input type="checkbox"/> <input type="checkbox"/> <input type="checkbox"/> <input type="checkbox"/> <input type="checkbox"/>	156	<input type="checkbox"/> <input type="checkbox"/> <input type="checkbox"/> <input type="checkbox"/> <input type="checkbox"/> <input type="checkbox"/> <input type="checkbox"/> <input type="checkbox"/> <input type="checkbox"/>
29	<input type="checkbox"/> <input type="checkbox"/> <input type="checkbox"/> <input type="checkbox"/> <input type="checkbox"/> <input type="checkbox"/> <input type="checkbox"/> <input type="checkbox"/> <input type="checkbox"/>	61	<input type="checkbox"/> <input type="checkbox"/> <input type="checkbox"/> <input type="checkbox"/> <input type="checkbox"/> <input type="checkbox"/> <input type="checkbox"/> <input type="checkbox"/> <input type="checkbox"/>	93	<input type="checkbox"/> <input type="checkbox"/> <input type="checkbox"/> <input type="checkbox"/> <input type="checkbox"/> <input type="checkbox"/> <input type="checkbox"/> <input type="checkbox"/> <input type="checkbox"/>	125	<input type="checkbox"/> <input type="checkbox"/> <input type="checkbox"/> <input type="checkbox"/> <input type="checkbox"/> <input type="checkbox"/> <input type="checkbox"/> <input type="checkbox"/> <input type="checkbox"/>	157	<input type="checkbox"/> <input type="checkbox"/> <input type="checkbox"/> <input type="checkbox"/> <input type="checkbox"/> <input type="checkbox"/> <input type="checkbox"/> <input type="checkbox"/> <input type="checkbox"/>
30	<input type="checkbox"/> <input type="checkbox"/> <input type="checkbox"/> <input type="checkbox"/> <input type="checkbox"/> <input type="checkbox"/> <input type="checkbox"/> <input type="checkbox"/> <input type="checkbox"/>	62	<input type="checkbox"/> <input type="checkbox"/> <input type="checkbox"/> <input type="checkbox"/> <input type="checkbox"/> <input type="checkbox"/> <input type="checkbox"/> <input type="checkbox"/> <input type="checkbox"/>	94	<input type="checkbox"/> <input type="checkbox"/> <input type="checkbox"/> <input type="checkbox"/> <input type="checkbox"/> <input type="checkbox"/> <input type="checkbox"/> <input type="checkbox"/> <input type="checkbox"/>	126	<input type="checkbox"/> <input type="checkbox"/> <input type="checkbox"/> <input type="checkbox"/> <input type="checkbox"/> <input type="checkbox"/> <input type="checkbox"/> <input type="checkbox"/> <input type="checkbox"/>	158	<input type="checkbox"/> <input type="checkbox"/> <input type="checkbox"/> <input type="checkbox"/> <input type="checkbox"/> <input type="checkbox"/> <input type="checkbox"/> <input type="checkbox"/> <input type="checkbox"/>
31	<input type="checkbox"/> <input type="checkbox"/> <input type="checkbox"/> <input type="checkbox"/> <input type="checkbox"/> <input type="checkbox"/> <input type="checkbox"/> <input type="checkbox"/> <input type="checkbox"/>	63	<input type="checkbox"/> <input type="checkbox"/> <input type="checkbox"/> <input type="checkbox"/> <input type="checkbox"/> <input type="checkbox"/> <input type="checkbox"/> <input type="checkbox"/> <input type="checkbox"/>	95	<input type="checkbox"/> <input type="checkbox"/> <input type="checkbox"/> <input type="checkbox"/> <input type="checkbox"/> <input type="checkbox"/> <input type="checkbox"/> <input type="checkbox"/> <input type="checkbox"/>	127	<input type="checkbox"/> <input type="checkbox"/> <input type="checkbox"/> <input type="checkbox"/> <input type="checkbox"/> <input type="checkbox"/> <input type="checkbox"/> <input type="checkbox"/> <input type="checkbox"/>	159	<input type="checkbox"/> <input type="checkbox"/> <input type="checkbox"/> <input type="checkbox"/> <input type="checkbox"/> <input type="checkbox"/> <input type="checkbox"/> <input type="checkbox"/> <input type="checkbox"/>
32	<input type="checkbox"/> <input type="checkbox"/> <input type="checkbox"/> <input type="checkbox"/> <input type="checkbox"/> <input type="checkbox"/> <input type="checkbox"/> <input type="checkbox"/> <input type="checkbox"/>	64	<input type="checkbox"/> <input type="checkbox"/> <input type="checkbox"/> <input type="checkbox"/> <input type="checkbox"/> <input type="checkbox"/> <input type="checkbox"/> <input type="checkbox"/> <input type="checkbox"/>	96	<input type="checkbox"/> <input type="checkbox"/> <input type="checkbox"/> <input type="checkbox"/> <input type="checkbox"/> <input type="checkbox"/> <input type="checkbox"/> <input type="checkbox"/> <input type="checkbox"/>	128	<input type="checkbox"/> <input type="checkbox"/> <input type="checkbox"/> <input type="checkbox"/> <input type="checkbox"/> <input type="checkbox"/> <input type="checkbox"/> <input type="checkbox"/> <input type="checkbox"/>	160	<input type="checkbox"/> <input type="checkbox"/> <input type="checkbox"/> <input type="checkbox"/> <input type="checkbox"/> <input type="checkbox"/> <input type="checkbox"/> <input type="checkbox"/> <input type="checkbox"/>

