

SNAP PAC Brains

Features

- Multi-protocol communications and I/O processor
- Handles analog, digital, and other SNAP I/O™ modules all on one mounting rack
- Distributed intelligence for your SNAP PAC system
- Choose Ethernet or serial network connections, both with multidrop capability, or choose a wireless LAN
- Ethernet-based brains are UL approved
- Factory Mutual-approved Ethernet versions available

Description

SNAP PAC brains are powerful and versatile I/O and network communications processors for your SNAP PAC System™. They are designed primarily to work in distributed systems controlled by a SNAP PAC programmable automation controller, but SNAP PAC Ethernet brains can also be used as intelligent remote I/O in an Allen-Bradley® RSLogix®-based PLC system or as PC-based I/O.

All SNAP PAC brains provide local intelligence that frees the controller for supervisory tasks. For example, each brain independently handles functions such as latching, counting, thermocouple linearization, watchdog timers, and PID loop control. These functions continue to work on the brain even if communication with the controller is lost.

SNAP PAC brains can also be used independently for standalone I/O processing and communication.

SNAP PAC brains use either Ethernet or serial networks.

- SNAP PAC **EB** brains communicate over a standard 10/100 Mbps Ethernet network. **EB-W** brains also communicate over a wireless LAN.
- SNAP PAC **SB** brains communicate over an RS-485 serial network, 2-wire or 4-wire, using a binary protocol.

EB Series Brains

SNAP PAC Ethernet Brains include the **SNAP-PAC-EB1** and the **SNAP-PAC-EB2**, both with Factory Mutual versions available (indicated by **-FM** at the end of the part number). These brains are identical in their functions and features except that the SNAP-PAC-EB1 provides high-speed digital functions for use with 4-channel digital I/O. The SNAP-PAC-EB2 does not offer high-speed digital functions. For a complete list of brain features, see [page 6](#).

Each SNAP PAC EB brain is equipped with two switched Ethernet network interfaces. Because these interfaces share a



SNAP-PAC-EB1 Brain

single IP address and act just like an Ethernet switch, SNAP PAC brains can be installed not only in a standard star configuration, but optionally in a multi-drop configuration, extending the control network without the expense of additional Ethernet network hardware.

Wired+Wireless™ EB Brains

The **SNAP-PAC-EB1-W** and **SNAP-PAC-EB2-W** brains add a wireless LAN interface as well. These brains can be used on a wired network, on a wireless LAN, or both at the same time.

Part Numbers

| Part | Description |
|-----------------|---|
| SNAP-PAC-EB1 | Ethernet-based analog, digital, and serial I/O and communications processor, with two switched Ethernet network interfaces and high-speed digital functions |
| SNAP-PAC-EB1-FM | Ethernet-based analog, digital, and serial I/O and communications processor, with two switched Ethernet network interfaces and high-speed digital functions, Factory Mutual approved |
| SNAP-PAC-EB1-W | Wired+Wireless Ethernet-based analog, digital, and serial I/O and communications processor, with two switched Ethernet network interfaces, one wireless LAN interface, and high-speed digital functions |
| SNAP-PAC-EB2 | Ethernet-based analog, digital, and serial I/O and communications processor, with two switched Ethernet network interfaces |
| SNAP-PAC-EB2-FM | Ethernet-based analog, digital, and serial I/O and communications processor, with two switched Ethernet network interfaces, Factory Mutual approved |
| SNAP-PAC-EB2-W | Wired+Wireless Ethernet-based analog, digital, and serial I/O and communications processor, with two switched Ethernet network interfaces and one wireless LAN interface |
| SNAP-PAC-SB1 | Serial-based analog and digital I/O and communications processor, with high-speed digital functions |
| SNAP-PAC-SB2 | Serial-based analog and digital I/O and communications processor |

For flexibility in designing your wireless network, 802.11a, b, and g standards are supported.

Wired+Wireless EB brains can be used with Wired+Wireless SNAP PAC S-series and R-series controllers and a variety of wireless switches and other infrastructure hardware. For the best security, the 802.11i/WPA2/AES standard is supported, while older WPA and WEP security standards are included for backwards compatibility.

Because wireless functionality is in the brain itself, no additional parts are required for wireless I/O processing or communication. All SNAP PAC racks and SNAP I/O modules can be used either wired or wirelessly. You can switch from one network to the other without reconfiguring I/O or changing field wiring. All features work the same on both networks. See the feature chart on [page 6](#).



SB Series Brains

The two SNAP PAC Serial Brains are the **SNAP-PAC-SB1** and the **SNAP-PAC-SB2**. Like the EB brains, the two SB brains are identical except that the SNAP-PAC-SB1 provides high-speed digital functions for use with 4-channel digital I/O. The SNAP-PAC-SB2 does not offer high-speed digital functions. See [page 6](#) for a comparison of brain features.

I/O Processing

Each SNAP PAC brain mounts on a SNAP PAC rack with up to 4, 8, 12, or 16 SNAP I/O modules.

View from top

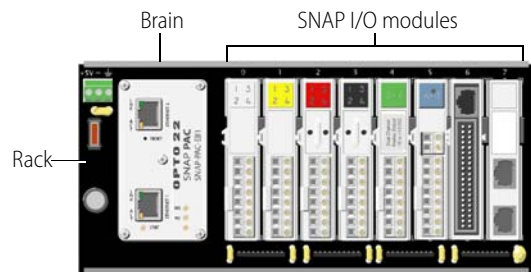

SNAP PAC EB brains support all SNAP analog, digital, and serial input and output modules. SNAP PAC SB brains support all SNAP analog and digital modules.

These modules can all be mixed on the same mounting rack and placed in any position on the rack, to accommodate the required mix of signals at any location. Each SNAP I/O module provides from 1 to 32 I/O points, depending on the module.

SNAP PAC Brains

The same racks and modules are used with Wired+Wireless EB brains as with regular EB brains. No additional hardware is needed for wireless communication.

For more information on mounting racks, see Opto 22 form #1684, the *SNAP PAC Racks Data Sheet*. For more information on SNAP I/O modules, visit our website at www.opto22.com.

Multiple Protocol Support on Ethernet

In addition to I/O processing, SNAP PAC Ethernet brains support communication using multiple protocols running simultaneously over Ethernet, including EtherNet/IP™, Modbus®/TCP, SNMP for network management, FTP for the brain's built-in file system, SMTP (email client), and Opto 22's open memory-mapped OptoMMP protocol. Communication with OPC 2.0-compliant clients is available through OptoOPCServer (see "[Software](#)," below).

Wired+Wireless EB brains support the same protocols over a wireless LAN and on a wired Ethernet network.

Software

SNAP PAC brains are primarily designed for use with a **SNAP PAC programmable automation controller**. The controller runs a control program built with PAC Project™ software. The PAC Project software suite comes in two forms, Basic and Professional.

- **PAC Project Basic**, which is included in the purchase of a SNAP PAC controller, consists of control programming, human-machine interface (HMI) creation, and configuration software.
- **PAC Project Professional** is available for purchase and adds OptoOPCServer™ for OPC connectivity, OptoDataLink™ for database communications, and additional features.

In addition to using a SNAP PAC controller with PAC Project software, you can communicate with SNAP PAC brains using the open and documented OptoMMP protocol. A free OptoMMP Communication Toolkit is available on our website, www.opto22.com. This toolkit includes ActiveX components and C++ classes, so you can use programming tools such as Visual Basic or Visual C++ to communicate with the brains. See form #1465, the *OptoMMP Protocol Guide*, for more information.

Ethernet brains can also communicate with **Allen-Bradley RSLogix® systems** using EtherNet/IP (see Opto 22 form #1770, the *EtherNet/IP for SNAP PAC Protocol Guide*, on our website).

In addition, Ethernet brains communicate using **Modbus/TCP**; see Opto 22 form #1678, the *Modbus/TCP Protocol Guide*, for more information.

SNAP PAC Brains

Specifications

| Ethernet and Serial Brains | |
|---|--|
| Power Requirements | 5.0–5.2 VDC at 750 mA maximum (does not include module power requirements) -W Models: 5.0–5.2 VDC at 1.0 A maximum (not including module requirements) |
| Memory | 16 MB RAM |
| Backup battery for real-time clock | Rechargeable (recharges whenever the brain has power). 5-year life when power is off (replacement part number: SNAP-PAC-BATTERY-ML2430). (Models manufactured before August 2007 have a 3-volt CR2032 lithium battery, available in retail stores. See original user guide for replacement steps.) |
| Hold-down screw | Torque: 8 in-lb (0.9 N-m) |
| Operating Temperature | -20 to 60 °C |
| Storage Temperature | -40 to 85 °C |
| Humidity | 0–95% humidity, non-condensing |
| Agency approvals and certifications | All models: CE, RoHS, DFARS Ethernet brains (EB): UL approved (-W models only) U.S., FCC Part 15 Subpart C; Canada, IC RSS-210 (-FM models only) Factory Mutual approved |
| Warranty | 30 months from date of manufacture |
| Ethernet Brains (EB) only | |
| Wired Ethernet Network Interfaces | IEEE 802.3 network, 10Base-T and 100Base-TX. Automatic MDC/MDI-X crossover (Ethernet crossover cable not required for direct connection to PC). Two switched interfaces, allowing multi-drop (daisy-chain) or standard star network configuration. |
| Maximum Ethernet Segment Length | 100 meters with Category 5 or superior UTP For 100 Mbps at this distance, use Category 5 or superior solid UTP. |
| Wireless LAN interface* Topologies Security Frequency 802.11a Frequency 802.11b/g Transmit Power Antenna Connector Roaming | Separate IP address Infrastructure, Ad-Hoc 802.11i: AES - Compatible with WPA2 Personal, TKIP - Compatible with WPA Personal, WEP. Note: TKIP/AES security is not supported in Ad-Hoc mode. 5.180–5.24 GHz, 5.745–5.825 GHz 2.412–2.472 GHz, 2.484GHz 15 dBm maximum Reverse polarity SMA (RP-SMA or RSMA) Supported within an SSID (Service Set Identifier) only |
| Serial Brains (SB) only | |
| Network interfaces | RS-485, 2- or 4-wire, twisted pair(s), with shield |
| Serial data rates | 300 baud to 230.4 Kbaud |
| Range: Serial multidrop | 32 stations maximum on a segment (including PC, controller, repeaters, and I/O units); up to 3000 ft (914 m) on a segment |
| Connector screw | Torque: 1.7 in-lb (0.19 N-m) |

* Requires Wired+Wireless model (SNAP-PAC-EB1-W or SNAP-PAC-EB2-W)

LEDs and Network Interfaces—Wired Ethernet Brains

This diagram applies to part numbers SNAP-PAC-EB1, SNAP-PAC-EB2, SNAP-PAC-EB1-FM, and SNAP-PAC-EB2-FM.

Switched Ethernet network interfaces

Brains can be networked in a daisy-chain configuration or in a standard star configuration using either Ethernet interface. Both interfaces use the same IP address.

NOTE: When using a daisy-chain configuration, be aware that if power to a brain is lost, all brains beyond it on the network will also lose communication. Firmware on daisy-chained brains must be updated one at a time.

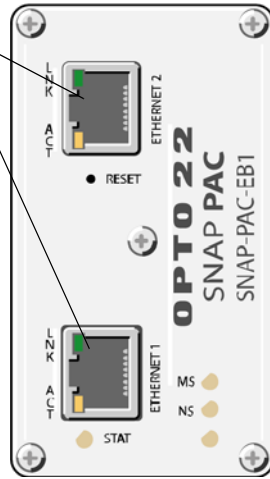

LEDs

| LED | Indicates |
|---------|--|
| LNK | Link established with Ethernet network |
| ACT | Activity on Ethernet network |
| STAT | Brain status |
| MS | EtherNet/IP Module Status |
| NS | EtherNet/IP Network Status |
| Unnamed | Reserved for future use |

LEDs and Network Interfaces—Wired+Wireless Ethernet Brains

This diagram applies to part numbers SNAP-PAC-EB1-W and SNAP-PAC-EB2-W.

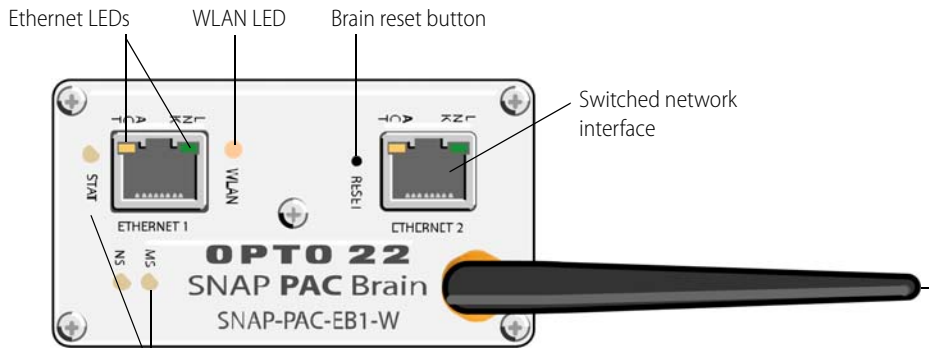

Status and activity LEDs

LEDs

| LED | Indicates |
|------|--|
| LNK | Link established with Ethernet network |
| ACT | Activity on Ethernet network |
| STAT | Brain status |
| MS | EtherNet/IP Module status |
| NS | EtherNet/IP Network status |
| WLAN | Wireless LAN status |

Note on switched Ethernet network interfaces

For a wired network, brains can be set up in a daisy-chain configuration or a standard star configuration using either the Ethernet1 or Ethernet2 network interface. Both interfaces use the same IP address.

When using a daisy-chain configuration, be aware that if power to a brain is lost, all brains beyond it on the network will also lose communication. Firmware on daisy-chained brains must be updated one brain at a time.

The WLAN interface does not provide access to other brains in a daisy-chain configuration, as this interface has a separate IP address.

SNAP PAC Brains

LEDs and Network Interfaces—Serial Brains

LEDs

| LED | Indicates |
|--------|---|
| SERIAL | Green = Transmit Red = Receive Amber = Transmit/Receive |
| STAT | Brain status |
| IRQ | Reserved for future use |

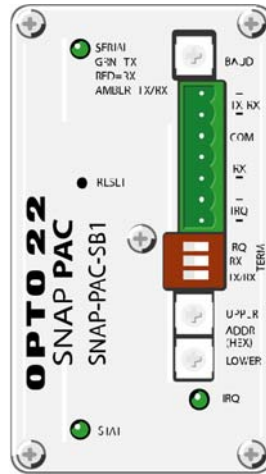

Serial port

On a serial brain, the port is RS-485, either 2-wire or 4-wire. Baud rate, termination, and address are set using the switches on the brain's top cover.

See form #1690, the *SNAP PAC Brains User's Guide*, for serial cable recommendations and wiring.

NOTE: IRQ connections and LED are reserved for future use.

Features

This table compares SNAP PAC brains with firmware 8.5 or newer.

| FEATURE | | SNAP-PAC-EB1 | SNAP-PAC-EB1-FM | SNAP-PAC-EB1-W | SNAP-PAC-EB2 | SNAP-PAC-EB2-FM | SNAP-PAC-EB2-W | SNAP-PAC-SB1 | SNAP-PAC-SB2 |
|---|---|--------------|-----------------|----------------|--------------|-----------------|----------------|--------------|--------------|
| Factory Mutual approval (U.S. and Canada) | | | ● | | | ● | | | |
| Ethernet networking | | ● | ● | ● | ● | ● | ● | | |
| Two switched Ethernet wired network interfaces (one IP address) | | ● | ● | ● | ● | ● | ● | | |
| Wired Ethernet network security (IP filtering, port access) | | ● | ● | ● | ● | ● | ● | | |
| Wireless LAN interface (802.11a, b, or g) | | | | ● | | | ● | | |
| Security for wireless network (WPA2-AES, WPA-TKIP, WEP) | | | | ● | | | ● | | |
| Serial networking (RS-485, 2-wire or 4-wire) | | | | | | | | ● | ● |
| Digital I/O point features | On/off status | ● | ● | ● | ● | ● | ● | ● | ● |
| | Input latching | ● | ● | ● | ● | ● | ● | ● | ● |
| | Watchdog timer | ● | ● | ● | ● | ● | ● | ● | ● |
| | High-speed counting (up to 20 kHz) ² | ● | ● | ● | | | | ● | |
| | Quadrature counting ³ | ● | ● | ● | | | | ● | |
| | On-pulse and off-pulse measurement ^{2,4} | ● | ● | ● | | | | ● | |
| | Frequency and Period measurement ⁴ | ● | ● | ● | | | | ● | |
| | TPO (time-proportional output) ⁴ | ● | ● | ● | ● | ● | ● | ● | ● |
| | Digital totalizing ⁴ | ● | ● | ● | ● | ● | ● | ● | ● |
| | Pulse generation (N pulses, continuous square wave, on-pulse, and off-pulse) ⁴ | ● | ● | ● | ● | ● | ● | ● | ● |
| Analog I/O point features | Thermocouple linearization (32-bit floating point for linearized values) | ● | ● | ● | ● | ● | ● | ● | ● |
| | Minimum/maximum values | ● | ● | ● | ● | ● | ● | ● | ● |
| | Offset and gain | ● | ● | ● | ● | ● | ● | ● | ● |
| | Scaling | ● | ● | ● | ● | ● | ● | ● | ● |
| | Time-proportional output ⁵ | ● | ● | ● | ● | ● | ● | ● | ● |
| | Output clamping | ● | ● | ● | ● | ● | ● | ● | ● |
| | Filter weight | ● | ● | ● | ● | ● | ● | ● | ● |
| | Watchdog timer | ● | ● | ● | ● | ● | ● | ● | ● |
| | Analog totalizing ⁴ | ● | ● | ● | ● | ● | ● | ● | ● |
| Ramping ⁴ | ● | ● | ● | ● | ● | ● | ● | ● | |
| I/O modules supported | Digital (4–32 channels per module) | ● | ● | ● | ● | ● | ● | ● | ● |
| | Analog (2–32 channels per module) | ● | ● | ● | ● | ● | ● | ● | ● |
| | Serial (RS-232, RS-485, motion control, Profibus®, Wiegand®) | ● | ● | ● | ● | ● | ● | | |

SNAP PAC Brains

| FEATURE | SNAP-PAC-EB1 | SNAP-PAC-EB1-FM | SNAP-PAC-EB1-W | SNAP-PAC-EB2 | SNAP-PAC-EB2-FM | SNAP-PAC-EB2-W | SNAP-PAC-SB1 | SNAP-PAC-SB2 |
|--|--------------|-----------------|----------------|--------------|-----------------|----------------|----------------|----------------|
| Maximum number of modules allowed per I/O unit (with largest rack): Any mix of 16 digital, 16 analog, 8 serial or special-purpose | ● | ● | ● | ● | ● | ● | ● ¹ | ● ¹ |
| PID logic on the brain (96 PID loops per brain) | ● | ● | ● | ● | ● | ● | ● | ● |
| Scratch Pad area for peer-to-peer data (bits, floats, integers, strings) | ● | ● | ● | ● | ● | ● | ● | ● |
| Realtime clock (RTC) | ● | ● | ● | ● | ● | ● | ● | ● |
| OPC driver support | ● | ● | ● | ● | ● | ● | ● ⁸ | ● ⁸ |
| OptoMMP memory-mapped protocol | ● | ● | ● | ● | ● | ● | ● | ● |
| EtherNet/IP™ (Allen-Bradley® Logix systems and others) | ● | ● | ● | ● | ● | ● | | |
| Modbus®/TCP (slave; maximum two Modbus Master connections) | ● | ● | ● | ● | ● | ● | | |
| SNMP (network management) ⁷ | ● | ● | ● | ● | ● | ● | | |
| FTP server, file system | ● | ● | ● | ● | ● | ● | | |
| Email (SMTP client) | ● | ● | ● | ● | ● | ● | | |
| UDP Streaming | ● | ● | ● | ● | ● | ● | | |
| Digital events, Alarm events, Serial events | ● | ● | ● | ● | ● | ● | ● ⁹ | ● ⁹ |
| Event messaging | ● | ● | ● | ● | ● | ● | | |
| Data logging in the brain | ● | ● | ● | ● | ● | ● | | |

¹ Does not support serial, motion control, Profibus, or Wiegand modules.

² Four-channel digital modules only; not available on high-density digital modules.

³ Requires a SNAP quadrature input module (SNAP-IDC5Q).

⁴ Available when used with PAC Control Pro 8.2+ or PAC Control Basic 9.0+ and a SNAP PAC controller; or when used as remote intelligent I/O with an Allen-Bradley PLC system.

⁵ Requires a SNAP analog TPO module (SNAP-AOD-29).

⁶ Digital I/O modules can be placed only in the first 8 slots on the rack.

⁷ Currently available on all types of modules except analog modules with more than 4 points.

⁸ Available when used with OptoOPCServer and PAC Control, through a SNAP PAC S-series controller.

⁹ Does not support serial events.

System Architecture

SNAP PAC brains are ideally suited for use as local I/O, logic, and communication processors in distributed systems.

The system shown below is controlled by a SNAP PAC S-series standalone controller running a PAC Control strategy. Some of the distributed I/O units are on an Ethernet network using EB brains, and some are on a serial network using SB brains. The controller handles all I/O on both networks.

SNAP PAC Ethernet brains can also be used as intelligent remote I/O with Allen-Bradley Logix PLC systems.

While the controller provides overall direction to the control system, each SNAP PAC brain locally handles counting, latching, thermocouple linearization, PID loop control, and other functions for the I/O modules on the racks. These local functions continue even if the controller loses communication with the brains.

PC used to develop a PAC Control strategy. Once developed, the strategy runs independently on the SNAP PAC controller.

SNAP PAC brains and I/O (distributed units). The top four are on an Ethernet network; the bottom two are on a serial network.

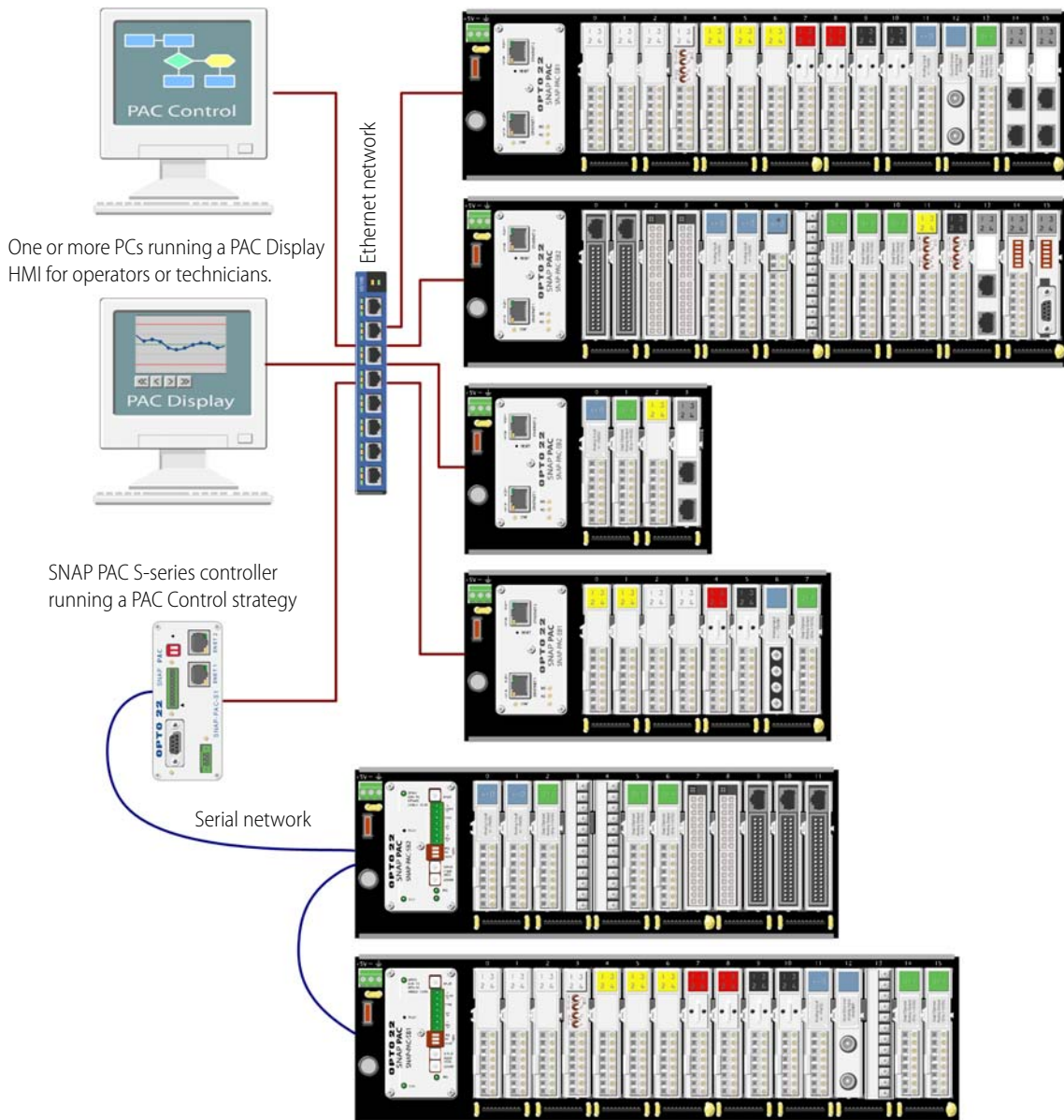

SNAP PAC Brains

System Architecture (continued)

Wired+Wireless SNAP PAC EB brains give you the option of using a wireless LAN for communication, either instead of or in addition to a wired Ethernet network.

All functions remain the same no matter which network is used, and if you change from wired to wireless or back again, no changes are needed to I/O modules or field wiring.

The following diagram shows Wired+Wireless EB brains used in a wireless network, controlled by a Wired+Wireless SNAP PAC

S-series controller.

In addition to controlling I/O on three networks (wireless LAN, wired Ethernet, and serial), the controller is connected to a second wired network for communication with PCs running PAC Control and PAC Display.

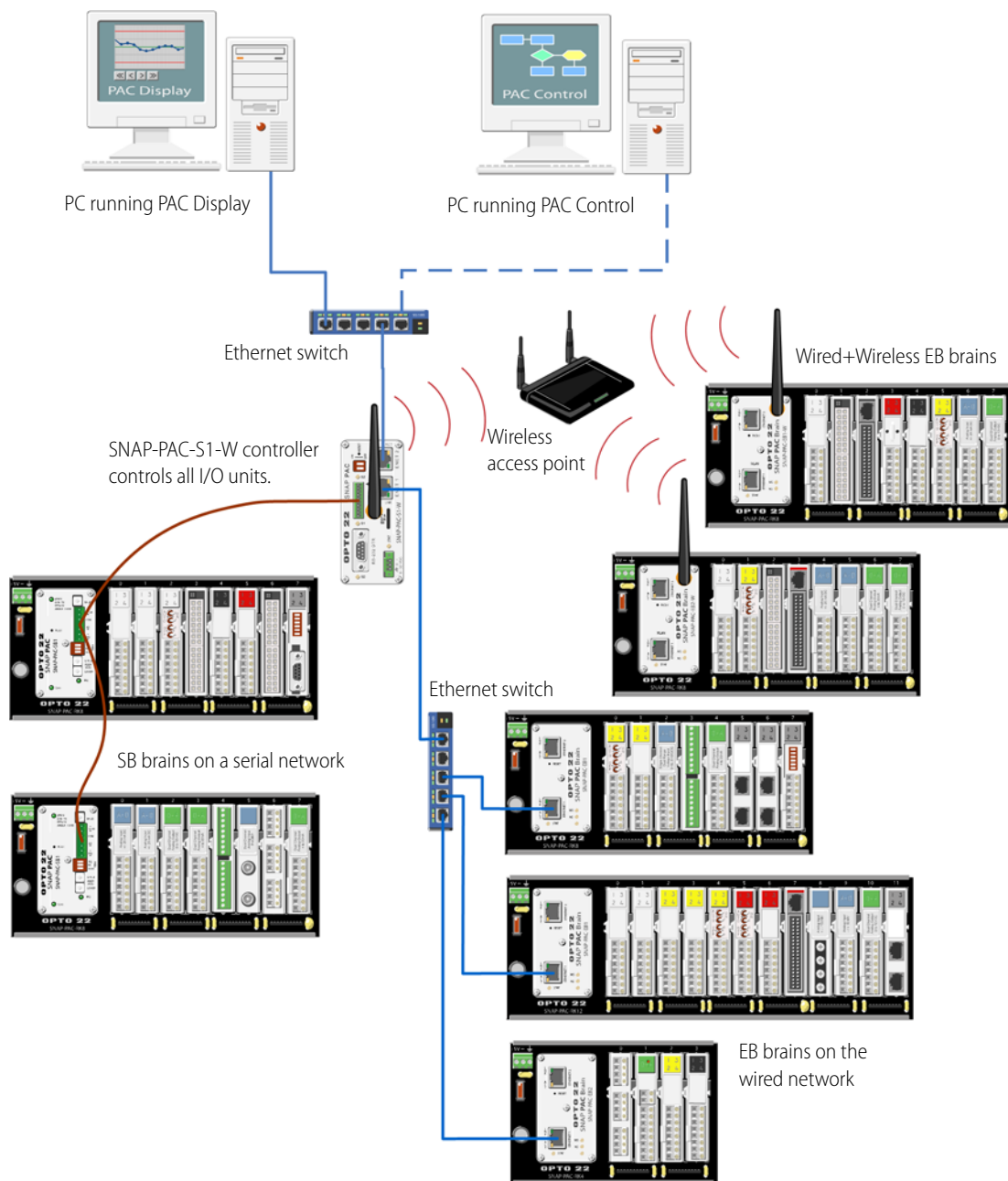

SNAP PAC Brains

System Architecture (continued)

SNAP PAC Ethernet Brains offer two options for wired networking. As shown in the diagram on [page 8](#), they can be networked in a standard star configuration using off-the-shelf Ethernet network switches or routers.

As shown below, SNAP PAC Ethernet brains can also be networked in a daisy-chain configuration, using the two switched Ethernet interfaces on each brain.

In this diagram, a rack-mounted SNAP PAC R-series controller runs the PAC Control strategy and controls the system. The distributed brains are daisy-chained together, eliminating the expense of additional routers or switches.

NOTE: A Wired+Wireless EB brain does not provide access to daisy-chained brains through its wireless LAN interface, because that interface has a different IP address. Data can go only through the wired interfaces, which use the same IP address.

PC used to develop a PAC Control strategy.
Once developed, the strategy runs independently on the SNAP PAC controller.



One or more PCs running a PAC Display HMI for operators or technicians.



SNAP PAC R-series controller running a PAC Control strategy

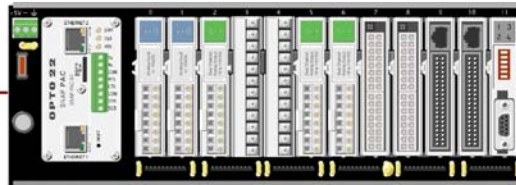

SNAP PAC EB brains and I/O (distributed units), daisy chained

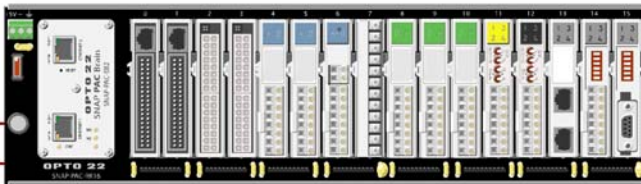
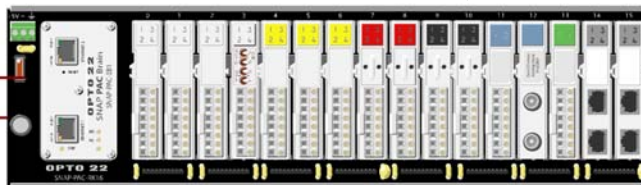

SNAP PAC Brains

System Architecture (continued)

While SNAP PAC Ethernet brains can communicate directly with other devices using several protocols over Ethernet, **SNAP PAC serial brains** communicate with OPC clients, corporate databases, and other third parties through a SNAP PAC S-series controller.

SNAP PAC Serial Brains with a SNAP PAC S-series Controller

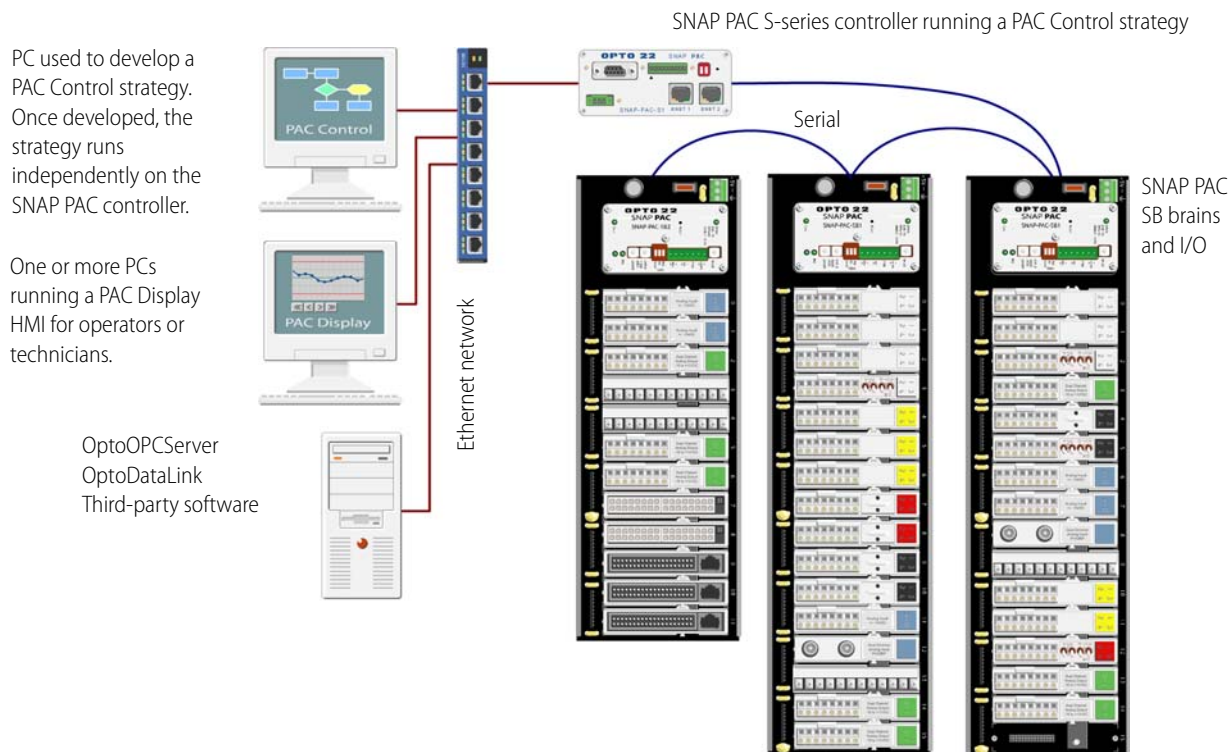

SNAP PAC Brains

Dimensional Drawing

Dimensions—SNAP PAC Ethernet Brains (except Wired+Wireless)

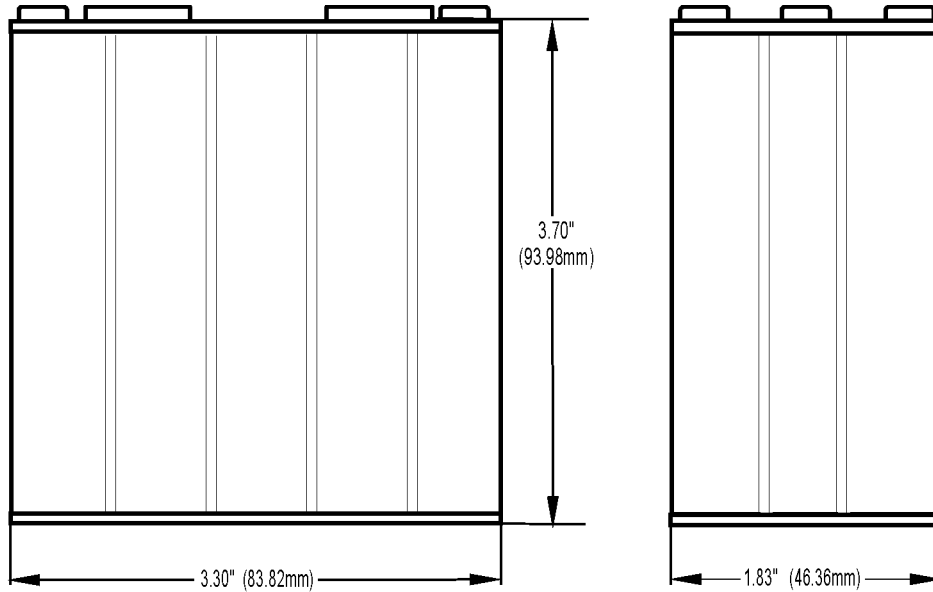

Dimensions—SNAP PAC Serial Brains

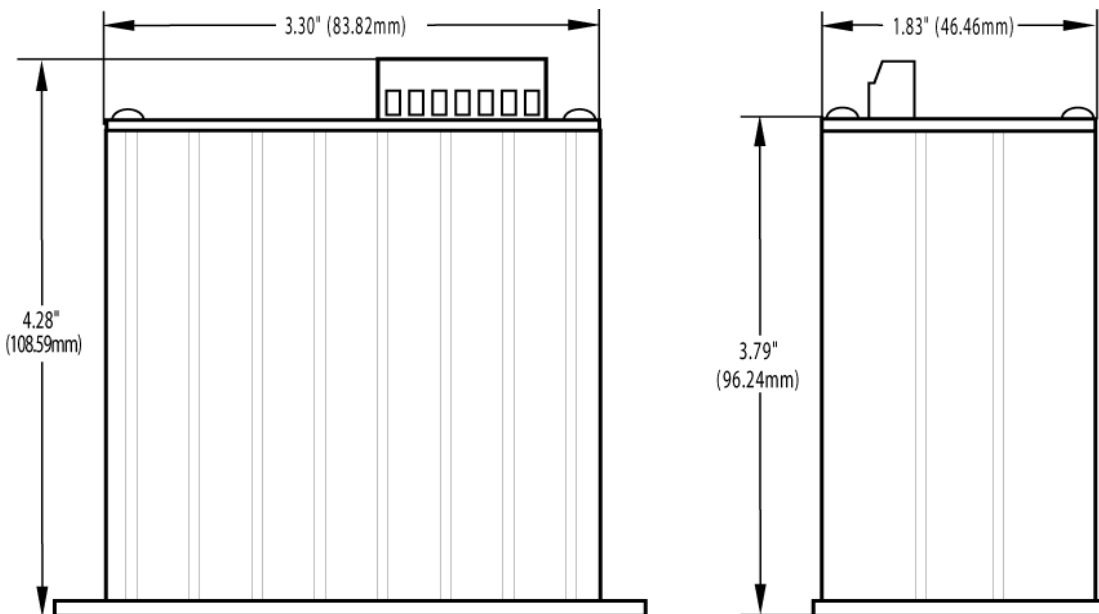

SNAP PAC Brains

Dimensional Drawing

Dimensions—Wired+Wireless SNAP PAC Ethernet Brains

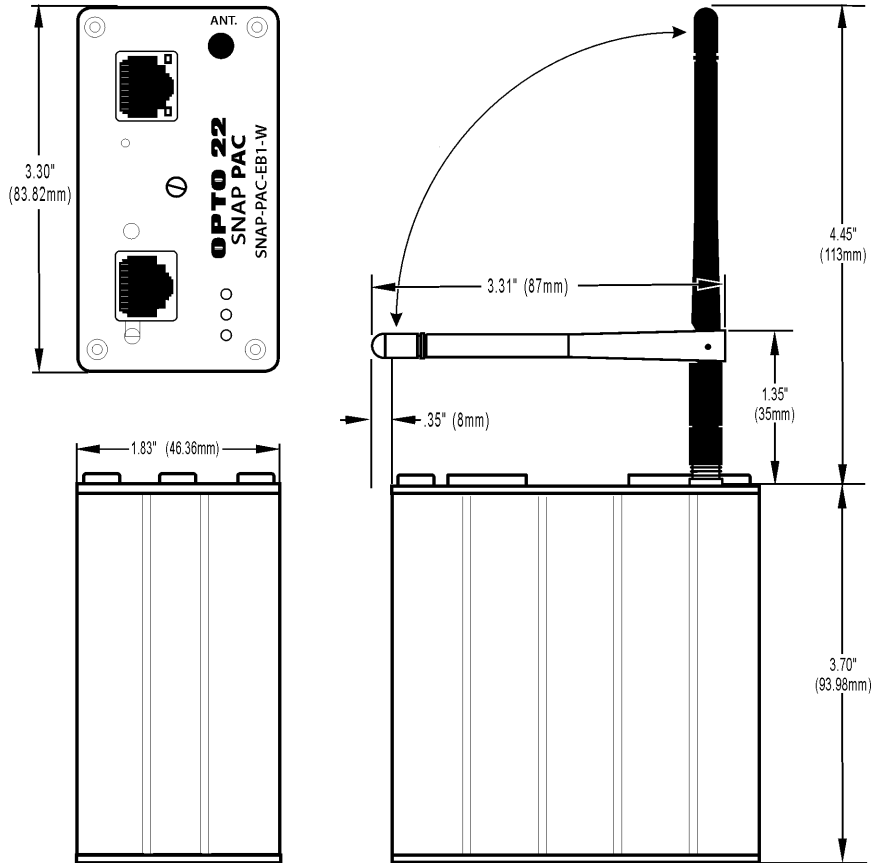

More About Opto 22

Products

Opto 22 develops and manufactures reliable, easy-to-use, open standards-based hardware and software products deployed worldwide.

Industrial automation, process control, building automation, industrial refrigeration, remote monitoring, data acquisition, Industrial Internet of Things (IIoT), and information technology applications all rely on Opto 22.



groov

Monitor and control your equipment from anywhere using your smartphone or tablet with groov. Build your own mobile app easily—just drag, drop, and tag. No programming or coding. Visit groov.com for more information and your free trial.

SNAP PAC System

Developer- and IIoT-ready, the SNAP PAC System connects physical assets to databases and applications using open standards. The SNAP PAC System consists of four integrated components:

- SNAP PAC controllers
- PAC Project™ Software Suite
- SNAP PAC brains
- SNAP I/O™

SNAP PAC Controllers

SNAP PAC programmable automation controllers handle a wide range of digital, analog, and serial functions for data collection, remote monitoring, process control, and discrete and hybrid manufacturing.

For IIoT applications and easier integration with company systems, standalone and rack-mounted SNAP PACs include a built-in HTTP/HTTPS server and **RESTful API** (application program interface). The REST API gives you secure, direct access to I/O and variable data using your choice of programming languages. No middleware, protocol converters, drivers, or gateways needed.

Based on open Ethernet and Internet Protocol (IP) standards, SNAP PACs make it easier to build or extend a system without the expense and limitations of proprietary networks and protocols.

PAC Project Software Suite

Opto 22's PAC Project Software Suite offers full-featured, cost-effective control programming, HMI (human machine interface), OPC server, and database connectivity software.

Control programming includes both easy-to-learn flowcharts and optional scripting. Commands are in plain English; variables and I/O point names are fully descriptive.

PAC Project Basic offers control and HMI tools and is free for download on our website, www.opto22.com. PAC Project Professional, available for separate purchase, adds one SoftPAC software-based controller, OptoOPCServer, OptoDataLink, options for controller redundancy or segmented networking, and support for legacy Opto 22 serial *mistic*™ I/O units.

SNAP PAC Brains

While SNAP PAC controllers provide central control and data distribution, SNAP PAC brains provide distributed intelligence for I/O processing and communications. Brains offer analog, digital, and serial functions, including thermocouple linearization, local PID loop control, watchdog, totalizing, and much more.

SNAP I/O

I/O provides the local connection to sensors and equipment. Opto 22 SNAP I/O offers 1 to 32 points of reliable I/O per module. Analog, digital, and serial modules are mixed on one mounting rack and controlled by a SNAP PAC brain or rack-mounted PAC.

Quality

Founded in 1974, Opto 22 has established a worldwide reputation for high-quality products. All are made in the U.S.A. at our manufacturing facility in Temecula, California.

Because we test each product twice before it leaves our factory, rather than only testing a sample of each batch, we can guarantee most solid-state relays and optically isolated I/O modules for life.

Free Product Support

Opto 22's California-based Product Support Group offers free, comprehensive technical support for Opto 22 products from engineers with decades of training and experience. Support is available in English and Spanish by phone or email, Monday–Friday, 7 a.m. to 5 p.m. PST.

Additional support is always available on our website: how-to videos, OptoKnowledgeBase, self-training guide, troubleshooting and user's guides, and OptoForums.

In addition, hands-on training is available for free at our Temecula, California headquarters, and you can [register online](#).

Purchasing Opto 22 Products

Opto 22 products are sold directly and through a worldwide network of distributors, partners, and system integrators. For more information, contact Opto 22 headquarters at 800-321-6786 (toll-free in the U.S. and Canada) or 951-695-3000, or visit our website at www.opto22.com.

{RESTful API}



www.opto22.com

www.opto22.com • Opto 22 • 43044 Business Park Drive • Temecula, CA 92590-3614 • Form 1335-160810
SALES 800-321-6786 • 951-695-3000 • FAX 951-695-3095 • sales@opto22.com • SUPPORT 800-835-6786 • 951-695-3080 • FAX 951-695-3017 • support@opto22.com

© 2013–2016 Opto 22. All rights reserved. Dimensions and specifications are subject to change. Brand or product names used herein are trademarks or registered trademarks of their respective companies or organizations.