

WATTNODE[®] WIDE-RANGE for MODBUS[®] Electric Power Meter - Reference Manual Model: WND-WR-MB

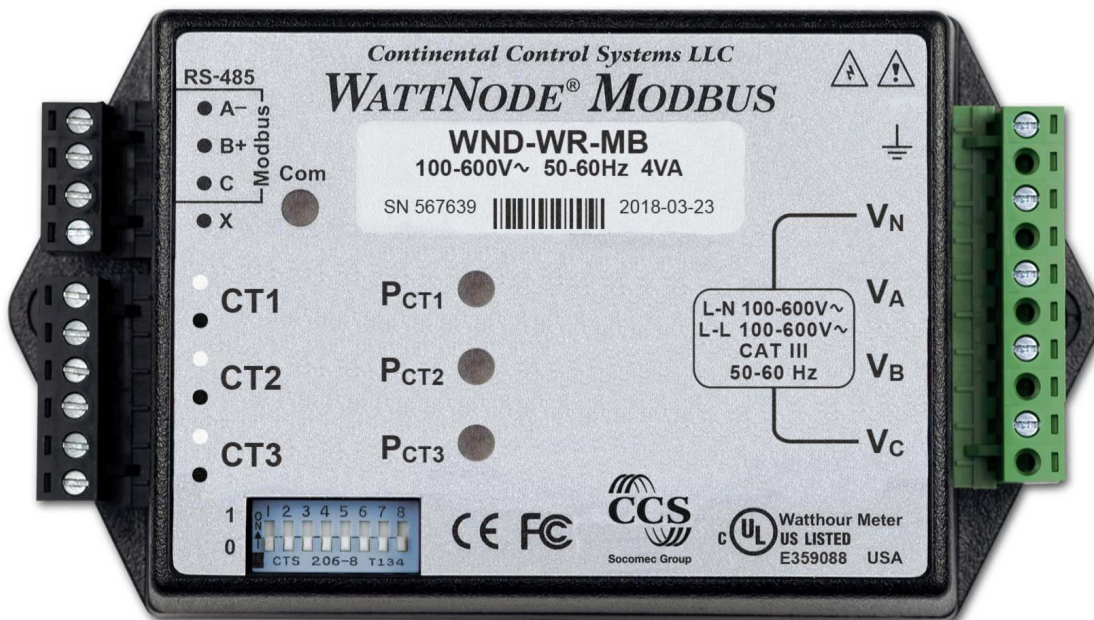

Information in this document is subject to change without notice.

©2007-2019 Continental Control Systems, LLC. All rights reserved.

Document Number: WND-WR-MB-Ref-1.01

Firmware Versions: 1033

Revision Date: April 15, 2019

Continental Control Systems, LLC.

+1 (303) 444-7422

FAX: +1 (303) 444-2903

E-mail: support@ctlsys.com

Website: <https://www.ctlsys.com>

WattNode® is a registered trademark of Continental Control Systems, LLC.

Modbus® is a registered trademark of Schneider Electric USA, Inc.

SunSpec® is a registered trademark of the SunSpec Alliance, Inc.

FCC Information

This equipment has been tested and complies with the limits for a Class B digital device, pursuant to part 15 of the FCC Rules. Operation is subject to the following two conditions: (1) This device may not cause harmful interference, and (2) this device must accept any interference received, including interference that may cause undesired operation.

The FCC limits are designed to provide reasonable protection against harmful interference in a residential installation. This equipment generates, uses and can radiate radio frequency energy and, if not installed and used in accordance with the instructions, may cause harmful interference to radio communications. However, there is no guarantee that interference will not occur in a particular installation. If this equipment does cause harmful interference to radio or television reception, which can be determined by turning the equipment off and on, the user is encouraged to try to correct the interference by one or more of the following measures:

- Reorient or relocate the receiving antenna.
- Increase the separation between the equipment and receiver.
- Connect the equipment into an outlet on a circuit different from that to which the receiver is connected.
- Consult the dealer or an experienced radio/TV technician to help.

Contents

1	Overview.....	6
1.1	Changes for WND Series	6
1.2	Measurements.....	6
1.3	Communication	7
1.4	Diagnostic LEDs	7
1.5	Options	7
1.5.1	General Options	7
1.5.2	Communication Options	8
1.5.3	Meter Element Configuration Options.....	8
1.5.4	Special Options	8
1.5.5	Cost Reduction Options	9
1.6	Current Transformers	9
1.7	Additional Literature.....	9
1.8	Front Label	10
1.8.1	Symbols.....	11
2	Installation.....	12
2.1	Precautions	12
2.2	Installation Checklist	12
2.3	Metering Theory	12
2.3.1	Variables and Terminology.....	13
2.3.2	Metering Configurations.....	14
2.4	Electrical Service Types.....	14
2.4.1	Single-Phase, Two-Wire, Line-to-Neutral.....	16
2.4.2	Single-Phase, Two-Wire, Line-to-Line	16
2.4.3	Single-Phase, Three-Wire (Split-Phase)	17
2.4.4	Three-Phase, Three-Wire Delta	17
2.4.5	Three-Phase, Four-Wire Wye	18
2.4.6	Three-Phase Four-Wire Delta (Wild Leg).....	18
2.4.7	Grounded Leg Service	18
2.5	Mounting	19
2.6	Selecting Current Transformers.....	20
2.6.1	Approved Current Transformers	20
2.6.2	Current Crest Factor	21
2.7	Connecting Current Transformers	21
2.7.1	Precautions	21
2.7.2	Installation Steps	21
2.8	Connecting Voltage Inputs	22
2.8.1	Circuit Protection	22
2.8.2	Line Wiring	23
2.8.3	Grounding	23
2.9	Connecting Modbus Outputs.....	23
2.9.1	RS-485 Cable.....	23
2.9.2	RS-485 Length Limits	24
2.9.3	RS-485 Termination	24
2.9.4	WattNode Internal Termination	25
2.9.5	RS-485 Biasing	25
2.10	Configure Modbus Settings.....	25
2.10.1	Setting the Modbus Address.....	25
2.10.2	Option AD Notes	26

2.10.3	Setting the Baud Rate	26
2.10.4	Setting the Parity and Stop Bits	26
2.10.5	Reset Communication Settings	27
2.11	Apply Power	27
3	Operating Instructions	28
3.1	Quick Start	28
3.1.1	WattNode Basic Configuration	28
3.1.2	Verify Operation	28
3.1.3	Measurement Overview	29
3.2	Maintenance and Repair	29
4	Modbus Interface and Registers	30
4.1	Modbus Overview	30
4.1.1	Modbus Functions	30
4.1.2	Report Slave ID	31
4.1.3	Firmware Field Upgrade	31
4.2	Modbus Registers	31
4.2.1	Modbus Register Addressing	31
4.2.2	Floating-Point and Integer Registers	32
4.2.3	Reading and Writing 32-bit Registers	32
4.2.4	Register Changes from the WNC to the WND Series	32
4.2.5	Measurement Register List - Floating-Point	34
4.2.6	Measurement Register List - Integer	35
4.2.7	Configuration Register List	37
4.2.8	Communication Register List	38
4.2.9	Diagnostic Register List	39
4.2.10	Option Information Registers	39
4.2.11	Custom Register Map	40
4.3	Measurement Registers	40
4.3.1	Energy	40
4.3.2	Active Energy	40
4.3.3	Negative Energy	41
4.3.4	Power	41
4.3.5	Reactive Energy	42
4.3.6	Apparent Energy	43
4.3.7	Reactive Power	43
4.3.8	Apparent Power	43
4.3.9	Voltage	44
4.3.10	Current	44
4.3.11	Frequency	45
4.3.12	Power Factor	45
4.3.13	Demand	45
4.4	Configuration	47
4.5	Communication Configuration	55
4.6	Diagnostics	57
4.7	Option Information	58
4.8	Communication Error Counts	60
4.9	Errors	60
4.9.1	Modbus Exceptions	60
4.9.2	ErrorStatus Registers	61
4.9.3	Error Codes	61

5	SunSpec Interface and Registers	64
5.1	Unimplemented SunSpec Registers	64
5.2	SunSpec Common Registers (Model 1).....	64
5.3	SunSpec Integer Energy Meter (Model 203)	65
5.4	SunSpec Floating-Point Energy Meter (Model 213).....	67
5.5	SunSpec CCS Custom Registers (Model 64080).....	68
5.6	SunSpec End Registers (Model 65535)	69
6	LED Indications and Troubleshooting.....	70
6.1	Power LED Diagnostics	70
6.2	Measurement Troubleshooting	73
6.2.1	Voltage Troubleshooting.....	73
6.2.2	Power Troubleshooting	73
6.2.3	Power Factor and Reactive Power Troubleshooting.....	74
6.3	Modbus Communication Diagnostics.....	75
7	Specifications.....	77
7.1	Models	77
7.2	Accuracy	77
7.3	Measurement	78
7.4	Modbus Communication.....	78
7.5	Electrical.....	78
7.5.1	Power Supply	78
7.5.2	General Electrical.....	79
7.5.3	Current Transformer Inputs	79
7.5.4	EIA RS-485 Modbus Interface.....	80
7.6	Regulatory	80
7.7	Environmental.....	80
7.8	Mechanical	81
7.8.1	Connectors	81
7.8.2	Standard Enclosure	81
8	Warranty	82
8.1	Limitation of Liability	82

1 Overview

Congratulations on your purchase of the WND series WattNode® Wide-Range for Modbus®. The WattNode Wide-Range offers precision AC electric energy and power measurements in a compact package. It is designed for use in demand side management (DSM), sub-metering, and energy monitoring applications. It communicates on an EIA RS-485 two-wire bus using the Modbus protocol.

The WattNode Wide-Range offers one model that measures any single-phase or three-phase circuit from 120 to 600 Vac. It is line powered from the V_N , V_A , and V_B terminals.

The WattNode provides revenue-grade system accuracy when used with the CCS Accu-CT family of revenue grade (C0.6) current transformers or other class 0.6, 0.3, or 0.2 CTs.

1.1 Changes for WND Series

The previous generation (third) of WattNode Modbus meters was referred to as the WNC-series meters. This manual covers the fourth generation WND series meters, which include the following changes (see [4.2.4 Register Changes from the WNC to the WND Series](#) for more details):

- Improved accuracy to meets ANSI C12.20 requirements, including better voltage and current measurement accuracy. See [7.2 Accuracy](#).
- Faster update rate: up to 10 updates per second for most variables. See [7.3 Measurement](#).
- Flexible configuration: allows remapping of current inputs to any voltage using Modbus registers. See [2.3.2 Metering Configurations](#) and [4.4 Configuration](#).
- Updates to the names for some registers for improved clarity. Since the names are only used for documentation, this does not affect backwards compatibility. See [4.2.4 Register Changes from the WNC to the WND Series](#) for details.
- Added support for SunSpec metering register sets. See [5 SunSpec Interface and Registers](#).
- Reports both positive and negative reactive energy for four-quadrant energy measurement. See [4.3.5 Reactive Energy](#).
- Adds detection of disconnected current transformers. See [CtMonitoring \(p. 53\)](#) and [CtStatus1, CtStatus2, CtStatus3 \(p. 57\)](#).
- Adds support for potential transformers with a new register: [PtRatio \(p. 54\)](#).
- The CT inputs can handle high crest factor waveforms without clipping. See [2.6.2 Current Crest Factor](#).
- Directly measures line-to-line voltages (WNC-series meters estimated these). See [4.3.9 Voltage](#).
- Support for firmware field upgrades. See [4.1.3 Firmware Field Upgrade](#).
- Lower noise floor (creep limit): can measure down to 0.04% of full-scale current and power. See [CreepLimit \(p. 51\)](#).
- Measures apparent power factor (PF = active power / apparent power) instead of displacement power factor. See [4.3.12 Power Factor](#).
- Measures the Budeanu reactive power (includes harmonics) instead of the fundamental reactive power. See [4.3.7 Reactive Power](#).
- X-pin options are not supported.
- Removes the auto polarity detection for RS-485 networks.

1.2 Measurements

The WattNode meter measures the following:

- Active power - Watts (per-element and sum)
- Reactive power - VARs (per-element and sum)

- Apparent power - VA (per-element and sum)
- Apparent power Factor (per-element and sum)
- Active energy - kWh (per-element and sum)
- Reactive energy - kVARh (per-element and sum)
- AC frequency
- RMS voltage (V_{AN} , V_{BN} , V_{CN} , V_{AB} , V_{BC} , V_{CA})
- RMS current (CT1, CT2, CT3)
- Demand and peak demand

One WattNode meter can measure up to three single-phase loads from the same service. If necessary, you can use different CT models on the different circuits.

1.3 Communication

The WattNode meter uses a half-duplex EIA RS-485 interface for communication. The standard baud rates are 9,600 and 19,200 baud, and rates from 1,200 to 115,200 baud can be configured. The meter uses the industry standard Modbus RTU (binary) communication protocol, allowing over 200 devices per RS-485 subnet.

There are numerous low-cost RS-485 interfaces to PCs, using both USB and serial ports. There are many PC programs and standalone devices for collecting and recording Modbus data.

1.4 Diagnostic LEDs

The meter includes three power diagnostic LEDs—one per phase. During normal operation, these LEDs flash on and off, with the speed of flashing roughly proportional to the power on each phase. The LEDs flash green for positive power and red for negative power. Other conditions are signaled with different LED patterns. See [6.1 Power LED Diagnostics](#) for details.

The WattNode Modbus meter includes a communication LED that lights green, yellow, or red to diagnose the RS-485 network. See [6.3 Modbus Communication Diagnostics](#) for details.

1.5 Options

WattNode meters can be ordered with several options. In most cases, the WattNode Wide-Range meter does not need to be ordered with any options, since most of these options just preconfigure settings that can be configured in the field by the end user. These options are most useful for large orders when many meters need to be configured a particular way or for situations where settings cannot be easily changed in the field.

1.5.1 General Options

- **CT=xxx** - Factory assign **xxx** as the global **CtAmps** value, or the rated amps for the attached current transformers. This in turn sets **CtAmps1**, **CtAmps2**, and **CtAmps3** to this value. **Option CT** is required if you are using **Option L**, which factory locks most settings.
- **CT=xxx/yyy/zzz** - Factory assign **xxx** to **CtAmps1**, **yyy** to **CtAmps2**, and **zzz** to **CtAmps3**. **Option CT** is required with **Option L**.
- **L** - Factory lock the CT amps rating (**CtAmps1**, **CtAmps2**, **CtAmps3**), potential transformer ratio (**PtRatio**), CT directions (**CtDirections**), gain adjust (**GainAdjust1**, **GainAdjust2**, **GainAdjust3**), phase adjust (**PhaseAdjust1**, **PhaseAdjust2**, **PhaseAdjust3**), creep limit/noise floor (**CreepLimit**, **VoltsNoiseFloor**), meter element configuration (**MeterConfig1**, **MeterConfig2**, **MeterConfig3**, **ConnectionType**), CT nominal full-scale voltage (**NomCtVolts1**, **NomCtVolts2**, **NomCtVolts3**), and disconnected CT monitoring (**CtMonitoring**) configuration registers. This option is intended for revenue application or other cases where you want to be certain the meter readings cannot be manipulated by changing the meter configuration registers. With this option, the register **OptLockedConfig** returns a

value of 1. A similar effect can be achieved using the **ConfigPasscode** register to lock the configuration.

1.5.2 Communication Options

You may use the following options to factory configure the communication settings. **Generally these options are not required because the DIP switch are typically used to set the baud rate and Modbus address.** These settings may also be changed in the field using the registers **Address**, **BaudRate**, **ParityMode**, **ModbusMode**, and **ApplyComConfig**.

- ***AD=xxx*** - Set the Modbus address to **xxx**.
- ***1.2K*** - Set the Modbus RS-485 baud rate to 1,200. Same as **BAUD=1200**.
- ***2.4K*** - Set the Modbus RS-485 baud rate to 2,400. Same as **BAUD=2400**.
- ***4.8K*** - Set the Modbus RS-485 baud rate to 4,800. Same as **BAUD=4800**.
- ***9.6K*** - Set the Modbus RS-485 baud rate to 9,600. Same as **BAUD=9600**.
- ***19K*** - Set the Modbus RS-485 baud rate to 19,200. Same as **BAUD=19200**.
- ***38K*** - Set the Modbus RS-485 baud rate to 38,400. Same as **BAUD=38400**.
- ***57K*** - Set the Modbus RS-485 baud rate to 57,600. Same as **BAUD=57600**.
- ***76K*** - Set the Modbus RS-485 baud rate to 76,800. Same as **BAUD=76800**.
- ***115K*** - Set the Modbus RS-485 baud rate to 115,200. Same as **BAUD=115200**.
- ***BAUD=xxx*** - Set the Modbus RS-485 baud rate to **xxx**, where **xxx** may be 1200, 2400, 4800, 9600, 19200, 38400, 57600, 76800, or 115200.
- ***EP*** - Set the Modbus RS-485 communications to even parity, with eight data bits and one stop bit (E81). The default is no parity. This is equivalent to setting **ParityMode = 1**.
- ***8N2*** - No parity, two stop bits (the default is one stop bit). This is equivalent to setting **ParityMode = 2**.

1.5.3 Meter Element Configuration Options

These are used to configure the **ConnectionType** or **MeterConfig** registers. Only one of the following two options may be specified for a particular meter.

- ***MCR=xx/yy/zz*** - Set **MeterConfig1** to **xx**, **MeterConfig2** to **yy**, and **MeterConfig3** to **zz**. See the **MeterConfig** registers for values.
- ***CTR=x*** - Set the **ConnectionType** register to **x**. See the **ConnectionType** register for values.

1.5.4 Special Options

Contact the factory about the following special options:

- ***MA*** - Specify that the meter uses 40mA output CTs in place of 0.33333 Vac CTs. This is equivalent to **Opt R=10,V=0.4**.
- ***R=xxx*** or ***R=xxx/yyy/zzz*** - Specify the addition of burden resistance for all three CT inputs or individually for each CT input. This means a burden resistor is installed in the meter to allow use of a milliamp output CT. If this option is not specified, then there are no burden resistors installed in the meter and the meter must be used with 0.333 Vac CTs (internally burdened millivolt output CTs). The **xxx**, **yyy**, and **zzz** values are the ohms of the burden resistors. Contact the factory for supported values.
- ***V=xxx*** or ***V=xxx/yyy/zzz*** - Specify the full-scale CT output voltage for all three CT inputs or individually for each CT input. If this option is not specified, then 0.33333 Vac is the default value. The **xxx**, **yyy**, and **zzz** values are in units of volts. This supports values from 0.1 to 0.5 Vac. Values below 0.25 Vac may affect the accuracy for low-current signals.
- ***PA=xxx/yyy/zzz*** - CT phase adjust (in millidegrees). This may be used to correct for known CT phase angle errors. When the **xxx**, **yyy**, and **zzz** arguments are the same, only one

argument should be entered as PA=xxx. This option determines the values that are written to the *PhaseAdjust1*, *PhaseAdjust2*, and *PhaseAdjust3* configuration registers.

1.5.5 Cost Reduction Options

These options are normally only available if the WattNode is ordered in high volume for OEM applications.

- **NDL** - No LEDs and no light pipes.
- **1PD** - (Single-phase delta) Only populate components for one CT channel (CT1). On the voltage inputs, do not populate or use low-cost/low-accuracy components for the N and L3 (phase C) inputs. Use normal connectors. Unless specified otherwise, this also sets **MeterConfig1,2,3** = 40, 0, 0.
- **1PY** - (Single-phase wye) Only populate components for one CT channel (CT1). On the voltage inputs, do not populate or use low-cost/low-accuracy components for the L2 and L3 inputs. Use normal connectors. Unless specified otherwise, this also sets **MeterConfig1,2,3** = 10, 0, 0.
- **1P** - (Single-phase) Only populate components for one CT channel (CT1). On the voltage inputs, do not populate or use low-cost/low-accuracy components for the L3 inputs. Use normal connectors. Unless specified otherwise, this also sets **MeterConfig1,2,3** = 10, 0, 0.

1.6 Current Transformers

The WattNode meter uses solid-core (toroidal), split-core (opening), bus bar, and Rogowski coil current transformers (CTs) with a full-scale voltage output of 0.33333 Vac. Split-core, bus bar, and Rogowski CTs are easier to install without disconnecting the circuit being measured. Solid-core CTs are more compact, generally more accurate, and less expensive, but installation requires that you disconnect the circuit to install the CTs.

The WND series WattNode meters also support milliamp output CTs with options MA, R, and V.

1.7 Additional Literature

These additional documents are available on the Continental Control Systems, LLC website or Modbus.org website.

- WattNode Wide-Range Meter for Modbus - Install Guide
 - <https://ctlsys.com/m/WND-WR-MB-Install-Guide.pdf>
- WattNode Wide-Range Meter for Modbus - Register List (Excel format)
 - <https://ctlsys.com/m/WND-MB-Registers-FW33.xls>
- WattNode Wide-Range Meter for Modbus - Declaration of Conformity
 - <https://ctlsys.com/m/WND-WR-MB-Decl-of-Conf.pdf>
- WattNode Wide-Range Meter for Modbus - SunSpec Certification
 - <https://ctlsys.com/m/SunSpec-Cert.pdf>
- Continental Control Systems, LLC Website Home Page
 - <https://www.ctlsys.com>
- WattNode Wide-Range Meter for Modbus - Product Page
 - <https://ctlsys.com/product/wattnode-modbus-wide-range/>
- Support articles
 - <https://ctlsys.com/cat/power-meters/>
- Modbus Protocol Specifications
 - <http://www.modbus.org/specs.php>

1.8 Front Label

This section describes the connections, information, and symbols on the front label.

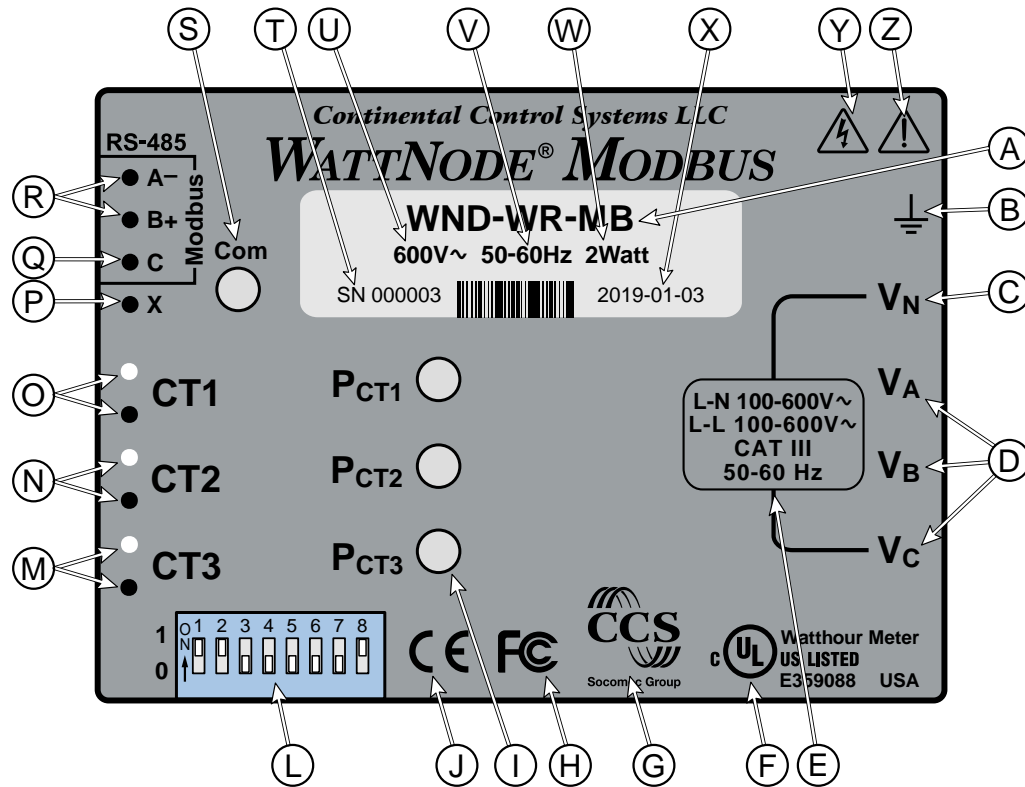

Figure 1: Front Label Diagram

- A: WattNode model number.** The “WND” indicates a fourth generation WattNode meter. The “WR” indicates a WattNode Wide-Range model and “MB” indicates Modbus output.
- B: Functional ground.** This terminal should be connected to earth ground if possible. It is not required for safety grounding, but ensures maximum meter accuracy.
- C: Neutral.** This terminal “V_N” should be connected to neutral when available.
- D: Line voltage inputs.** These terminals connect to the electric mains.
- E: Line voltage measurement ratings.** This block lists the line-to-neutral “L-N” voltage range, line-to-line “L-L” voltage range, the measurement category “CAT III”, and the operating frequency range for this WattNode model. See [7 Specifications](#) for more information.
- F: UL Listing mark.** This shows the UL logo and file number indicating U.S. and Canadian listing.
- G: Continental Control Systems, LLC logo**
- H: FCC Mark.** This logo indicates that the meter complies with part 15 of the FCC rules.
- I: Meter element LEDs.** These are LEDs used to verify and diagnose meter element operation. The P_{CT1} LED shows the power and status of the first meter element associated with CT₁, and so on. See [6.1 Power LED Diagnostics](#) for details.
- J: CE mark.** Indicates compliance with the regulations of the European Union for product safety and electro-magnetic compatibility.
- L: DIP switch.** This DIP switch block is used to set the Modbus address and baud rate. See [2.10.1 Setting the Modbus Address](#).

M, N, O: Current transformer (CT) inputs. These indicate CT screw terminals. Note the white and black circles at the left edge of the label: these indicate the color of the CT wire that should be inserted into the corresponding screw terminal.

P: Auxiliary output terminal. This terminal is not used on the WattNode Wide-Range meter.

Q: Modbus common terminal. This is the common or ground terminal for Modbus EIA RS-485 communication wiring.

R: Modbus signal terminals. These are the RS-485 A- and B+ signals (half-duplex, two-wire). There are several names for these terminals:

- **Inverting pin:** A-, A, -, TxD-, RxD-, D0, and sometimes “B”
- **Non-inverting pin:** B+, B, +, TxD+, RxD+, D1, and sometimes “A”

S: Communication status. This LED indicates communication status. See [6.3 Modbus Communication Diagnostics](#) for details.

T: Serial number. This shows the serial number of the meter.

U: Mains supply rated voltage. This is the rated supply voltage for this model. The **V~** indicates AC voltage.

V: Mains frequencies. This indicates the rated mains frequencies for the meter.









W: Maximum rated power. This is the maximum power consumption for this model.

X: Manufacture date. This is the date of manufacture for this WattNode meter.

Y: Caution, risk of electrical shock. This symbol indicates that there is a risk of electric shock when installing and operating the meter if the installation instructions are not followed correctly.

Z: Attention - consult Manual. This symbol indicates that there can be danger when installing and operating the meter if the installation instructions are not followed correctly.

1.8.1 Symbols

	Read, understand, and follow all instructions including warnings and precautions before installing and using the product.
	Potential Shock Hazard from Dangerous High Voltage.
	Functional ground; should be connected to earth ground if possible, but is not required for safety grounding.
	UL Listing mark for U.S.A. and Canada.
	UL Recognized mark.
	FCC Mark. This logo indicates compliance with part 15 of the FCC rules.
	Complies with the regulations of the European Union for Product Safety and Electro-Magnetic Compatibility. <ul style="list-style-type: none">• Low Voltage Directive – EN 61010-1:2010 (3rd Edition)• EMC Directive – EN 61326-1:2013
	This indicates an AC voltage.

2 Installation

2.1 Precautions



DANGER – HAZARDOUS VOLTAGES

WARNING - These installation/servicing instructions are for use by qualified personnel only. To avoid electrical shock, do not perform any servicing other than that contained in the operating instructions unless you are qualified to do so.

Always adhere to the following checklist:

- 1) Only qualified personnel or **licensed electricians** should install the WattNode. The mains voltages of 100 Vac to 600 Vac can be lethal!
- 2) Follow all applicable local and national electrical and safety codes.
- 3) The terminal block screws are **not** insulated. Do not contact metal tools to the screw terminals if the circuit is live!
- 4) Verify that circuit voltages and currents are within the proper range for the meter model.
- 5) Use only UL Listed or UL Recognized current transformers (CTs). Depending on the meter options, you may use either CTs with built-in burden resistors that generate 0.333 Vac (333 millivolts AC) at rated current or milliamp output CTs that generate up to 100 mA at rated current. **Do not use 1 amp or 5 amp output CTs: they will destroy the meter and may create a shock hazard.**
- 6) Disconnect equipment from HAZARDOUS LIVE voltages before access.
- 7) If the meter is not installed correctly, the safety protections may be impaired.

2.2 Installation Checklist

See the sections referenced below for installation details.

- Turn off power** before making line voltage connections.
- Mount the meter (see [2.5](#)).
- Connect the line voltage wires to the meter's green terminal block (see [2.8](#)).
- Install the CTs around the line conductors. Make sure the CTs face the **source** (see [2.7](#)).
- Connect the twisted white and black wires from the CTs to the black terminal block on the meter, matching the wire colors to the white and black dots on the meter label (see [2.7](#)).
- Check that the CT inputs match the line voltage phases.
- Record the CT rated current for each CT. They are required for commissioning.
- Connect the Modbus output terminals of the meter to the monitoring equipment (see [2.9](#)).
- Check that all the wires are securely installed in the terminal blocks by tugging on each wire.
- Turn on the line voltage connection to the meter.
- Verify that the LEDs indicate correct operation (see [2.11](#)).

2.3 Metering Theory

The WND-series meters, including the WattNode Wide-Range, use a new internal design that allows arbitrary mapping of the current transformer (CT) inputs to the voltage inputs. This mapping provides the following benefits:

- Many wiring mistakes can be fixed remotely by reconfiguring registers. For example, it is a common mistake to mismatch the inputs, so that the line voltage inputs are monitoring L1, L2, L3, while the CTs are installed around L2, L3, L1 respectively. This can be easily corrected by changing the **MeterConfig** registers.
- You can measure U.S. residential 240 V single-phase two-wire loads with a single CT.

- You can measure three single-phase branch circuits by connecting just V_N and V_A and then configuring all three CTs to use V_{AN} . By comparison, on a WNC-series meter, you would need to jumper the line voltage to all three line Vac inputs.
- You can associate a CT with a line-to-line voltage, such as **CT1** with V_{AB} . This allows you to monitor a single-phase line-to-line load with one CT (the WNC-series meters required two CTs), or to monitor a three-phase delta load with two CTs (the WNC-series meters required three CTs). It also means you can monitor three separate single-phase, line-to-line loads with one meter.

2.3.1 Variables and Terminology

To help explain the changes in the WND series of meters, we first introduce some terms and variables. For the following definitions, the V_N screw terminal will be connected to neutral (if present). The V_A , V_B , and V_C screw terminals may be connected in any order to one or more line voltages such as L1, L2, and L3.

- **voltage channel:** this is a pair of line voltage inputs taken together, such as the voltage between the V_A and V_N terminals (V_{AN}). For power metering, all voltage measurements must be referenced to some other voltage to get either line-to-neutral or line-to-line voltages. The full set of voltage channels contains V_{AN} , V_{BN} , V_{CN} , V_{AB} , V_{BC} , and V_{CA} .
- **nominal voltage:** the meter's nominal line-to-neutral voltage rating. For the WattNode Wide-Range, the nominal voltage is 347.0 Vac.
- **active voltage channel:** an active voltage channel is one where the measured voltage is above the voltage noise floor, typically 69 Vac for the WattNode Wide-Range model. See the [*VoltsNoiseFloor \(1637\)*](#) register for details.
- **meter element:** a meter element associates a current signal (from a CT) with a voltage channel signal to compute power, energy, and other values. Each WattNode meter contains three meter elements.
- **active meter element:** a meter element is active if its voltage channel is active, the associated *MeterConfig* register is not zero (disabled), and the associated *CtAmps* register is not zero (disabled). Inactive meter elements report zero power and the associated LED will be off.
- **two-wire:** an electrical service with two current-carrying wires, not including the ground wire. The two wires are either line and neutral, or two line wires.
- **three-wire:** an electrical service with three current-carrying wires, not including the ground wire.
- **four-wire:** an electrical service with four current-carrying wires, not including the ground wire. Four-wire services always have a neutral conductor.
- **delta:** a type of three-phase electrical service most commonly with three wires, no neutral, and the three phase conductors rotated 120° from each other.
- **wye:** a type of three-phase electrical service with four wires, neutral, and the three phase conductors rotated 120° from each other.
- V_{AN} : the voltage between the V_A and V_N terminals ($V_A - V_N$). Reported with the Modbus register *VoltAN*.
- V_{BN} : the voltage between the V_B and V_N terminals. Reported with the register *VoltBN*.
- V_{CN} : the voltage between the V_C and V_N terminals. Reported with the register *VoltCN*.
- V_{AB} : the voltage between the V_A and V_B terminals ($V_A - V_B$). This is reported with the register *VoltAB*.
- V_{BC} : the voltage between the V_B and V_C terminals. Reported with the register *VoltBC*.
- V_{CA} : the voltage between the V_C and V_A terminals. Reported with the register *VoltCA*.
- **CT1:** the **CT1** screw terminals or the current measured by the CT connected to **CT1**.
- **CT2:** the **CT2** screw terminals or the current measured by the CT connected to **CT2**.
- **CT3:** the **CT3** screw terminals or the current measured by the CT connected to **CT3**.

To be clear, math like $V_A - V_N$ is phasor math. For example, for an ideal 120/208 wye service, V_A and V_B are each 120 Vac, while $V_A - V_B$ is 208 Vac (not $120 - 120 = 0$ Vac).

2.3.2 Metering Configurations

There are three meter elements (1, 2, and 3) in the WattNode meter, associated with the three CT inputs: **CT1**, **CT2**, and **CT3**, respectively. The associated voltage can be any of the line-to-neutral voltages (V_{AN} , V_{BN} , or V_{CN}) or any of the line-to-line voltages (V_{AB} , V_{BC} , or V_{CA}).

By default, the WattNode meter is configured to behave just like a WNC-series WattNode meter. This is optimized for monitoring three-phase wye circuits, but can be used for any circuit. The **MeterConfig1**, **MeterConfig2**, and **MeterConfig3** registers (one for each meter element) control these configurations.

- **Element 1: CT1** and V_{AN} (**MeterConfig1** = 10)
- **Element 2: CT2** and V_{BN} (**MeterConfig2** = 20)
- **Element 3: CT3** and V_{CN} (**MeterConfig3** = 30)

With this configuration, if you wish to monitor a delta service, you will need to use three CTs.

Below are the most common meter element configurations.

- Wye circuit
- Delta circuit
- Three single-phase branch circuits
- House and PV inverter
- Single-phase, line-to-line

For more details see the section below [4.4 Configuration](#).

2.4 Electrical Service Types

The WattNode meter supports any electrical service from 100 to 600 Vac, line-to-neutral or line-to-line, 50 to 60 Hz, single-phase, split-phase, or three-phase, wye or delta.

Connect the line voltages to the meter inputs as shown in the following figures for each service type.

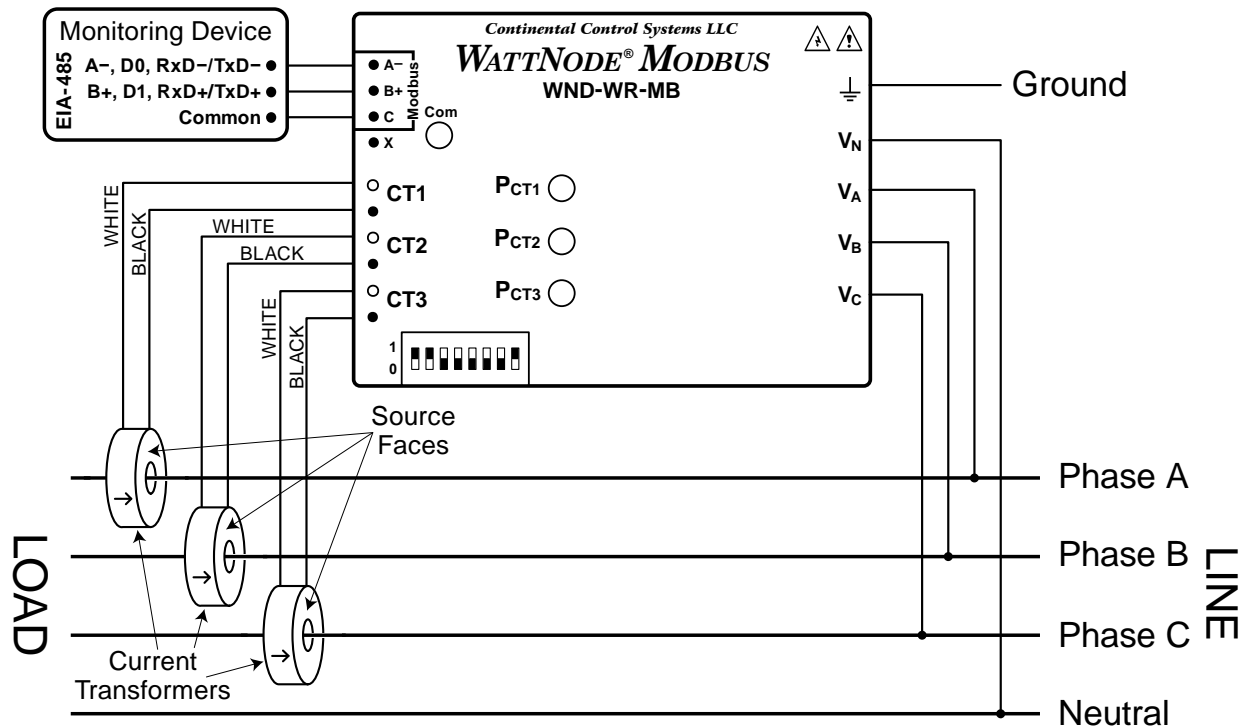

Figure 2: General Wiring Diagram

Note: the ground connection improves measurement accuracy, but is not required for safety.

Internally, the WattNode meter acts as three separate single-phase meters, one tied to each CT input. By default, **CT1** is associated with V_{AN} (or $V_A - V_N$), **CT2** with V_{BN} , and **CT3** with V_{CN} . In this default configuration, two CTs are required to measure single-phase, two-wire, line-to-line service and three CTs are required to measure three-phase, three-wire, delta service. By changing the meter configuration, it is possible to use one less CT as documented for the service types below.

The following table shows the different options for the **ConnectionType (1636)** register. The default **ConnectionType = 1** may be used for most service types, but will require the use of an additional current transformer (CT) for three-wire delta and single-phase, line-to-line services.

Table 1: Meter Connection Types

ConnectionType	Description
0	Custom settings using MeterConfig registers
1 (default)	Single-phase, two-wire, line-to-neutral (1 CT) Single-phase, two-wire, line-to-line (2 CTs) Single-phase, three-wire (split-phase) (2 CTs) Three-phase, three-wire delta (3 CTs) Three-phase, four-wire delta (3 CTs) Three-phase, four-wire wye (3 CTs)
2	Three-phase delta (2 CTs)
3	Up to three single-phase, line-to-neutral circuits (1 CT per circuit)
4	House and inverter for U.S. residential (3 CTs)
5	Single-phase, two-wire, line-to-line (1 CT)

2.4.1 Single-Phase, Two-Wire, Line-to-Neutral

This is a common residential and branch circuit connection. The CT should be placed around the line conductor and connected to the **CT1** terminal as shown in [Figure 3](#).

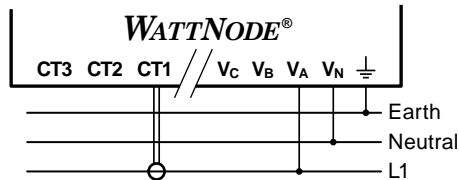

Figure 3: Single-Phase, Two-Wire, Line-to-Neutral (*ConnectionType* = 1)

Up to three such single-phase circuits may be monitored with one meter using three CTs by connecting the second and third circuit line voltages to the **VB** and **VC** terminals and the additional CTs to **CT2** and **CT3** respectively as shown in [Figure 2](#).

Another option that does not require connections to **VB** and **VC** is shown in [Figure 4](#); this requires that you set the register *ConnectionType* = 3. In this configuration, the three L1 lines represent three different branch circuits on L1 (although they could also all be on L2 or L3).

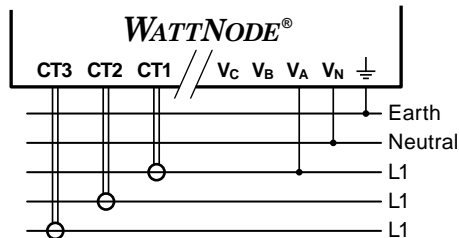

Figure 4: Three Single-Phase, Line-to-Neutral Circuits (*ConnectionType* = 3)

2.4.2 Single-Phase, Two-Wire, Line-to-Line

This circuit occurs in residential (commonly 120/240 Vac and called split-phase) and some commercial applications (208, 240, 277, or 400 Vac). The two conductors have AC waveforms 120° or 180° out of phase. Neutral is not used or carries no current.

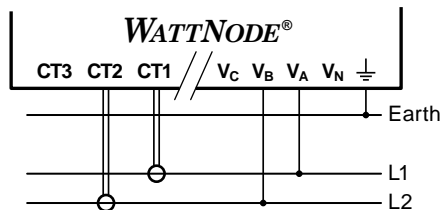

Figure 5: Single-Phase, Two-Wire, Line-to-Line Connection (*ConnectionType* = 1)

With the default *ConnectionType* = 1, two CTs are required as shown in the figure above. Alternatively, you may use a single CT and set *ConnectionType* = 5 as shown below.

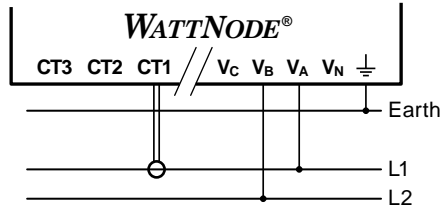

Figure 6: Single-Phase, Two-Wire, Line-to-Line Connection (*ConnectionType* = 5)

2.4.3 Single-Phase, Three-Wire (Split-Phase)

This is a common North American residential service at 120/240 Vac. The three wires refer to a mid-point neutral and two line voltage conductors with AC waveforms 180° or 120° out of phase; this results in 120 Vac between the line conductors and neutral, and 240 Vac (or sometimes 208 Vac) between the two line conductors. Two CTs are required to measure this circuit.

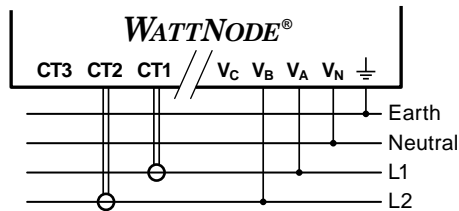

Figure 7: Single-Phase, Three-Wire Connection (*ConnectionType* = 1)

2.4.4 Three-Phase, Three-Wire Delta

This is common in commercial and industrial settings. In some cases, the service may be four-wire wye while the load is three wire (no neutral). Neutral is not used, just three mains lines with AC waveforms shifted 120° between the successive phases. With this configuration, you may connect the line voltage wires to the **V_A**, **V_B**, and **V_C** terminals in any order, **so long as the CTs are connected to matching phases**.

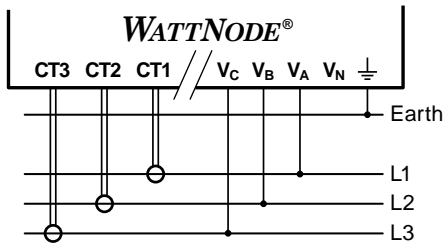

Figure 8: Three-Phase, Three-Wire Delta Connection (*ConnectionType* = 1)

With the default *ConnectionType* = 1, three CTs are required as shown in the figure above. In this case, you will get measurements for all three phase currents (**Current1**, **Current2**, and **Current3**) and the individual phase (or element) readings for power, energy, and power factor should be well balanced.

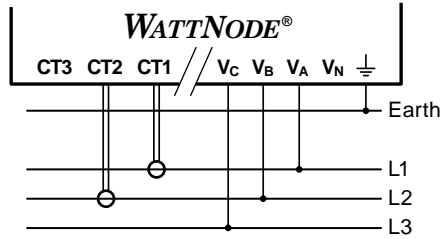

Figure 9: Three-Phase, Three-Wire Delta Connection (*ConnectionType* = 2)

Alternatively, you may use two CTs and set *ConnectionType* = 2 as shown above. In this case, you will only get measurements for two phases (or elements): **Current1**, **Current2**, **Power1**, **Power2**, etc. The third phase measurements will all be zero. In addition, the active power, reactive power, and power factor measurements will generally not be balanced between the two phases because of the effect of using L3 as the reference point for the measurements.

2.4.5 Three-Phase, Four-Wire Wye

This is the most common commercial and industrial service. The conductors are neutral and three phase lines with AC waveforms shifted 120° between phases. You may connect the line voltage conductors to the **V_A**, **V_B**, and **V_C** terminals in any order, **so long as the CTs are connected to matching phases**. It is important that you connect **V_N** (neutral) for accurate measurements.

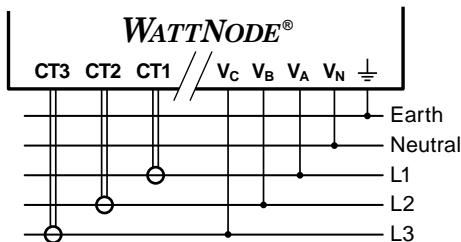

Figure 10: Three-Phase Four-Wire Wye Connection (*ConnectionType* = 1)

2.4.6 Three-Phase Four-Wire Delta (Wild Leg)

The uncommon four-wire delta electrical service is a three-phase delta service with a center-tap on one of the transformer windings to create a neutral for single-phase loads. This can be treated just like the [2.4.5 Three-Phase, Four-Wire Wye](#) for metering purposes.

See <https://ctlsys.com/s/4wd/> for details.

2.4.7 Grounded Leg Service

In some cases with delta services or single-phase two-wire services without neutral, one of the phases may be grounded. You can check for this by using a multimeter (DMM) to measure the voltage between each phase and ground. If you see readings between 0 and 5 Vac, that leg is probably grounded (sometimes called a “grounded delta”).

The WattNode meter correctly measures services with a grounded leg, but the measured voltage and power for the grounded phase will be zero and the meter element LED will not light for whichever phase is grounded, because the voltage is near zero. Also, the active (non-grounded) phases may indicate lower or higher power factor because this type of service results in unusual power factors.

If you have a grounded leg configuration, you can save money by removing the CT for the grounded phase, since all the power is measured on the non-grounded phases.

We recommend putting the grounded leg on the **V_B** or **V_C** inputs and attaching a note to the meter indicating this configuration for future reference.

See the web article <https://ctlsys.com/s/corner-gnd/> for more information.

2.5 Mounting

Protect the meter from temperatures below -40°C (-40°F) or above 80°C (176°F), excessive moisture, dust, salt spray, or other contamination, using a NEMA rated enclosure if necessary. The meter requires an environment no worse than pollution degree 2 (normally only non-conductive pollution; occasionally, a temporary conductivity caused by condensation). The meter may be installed in any orientation.

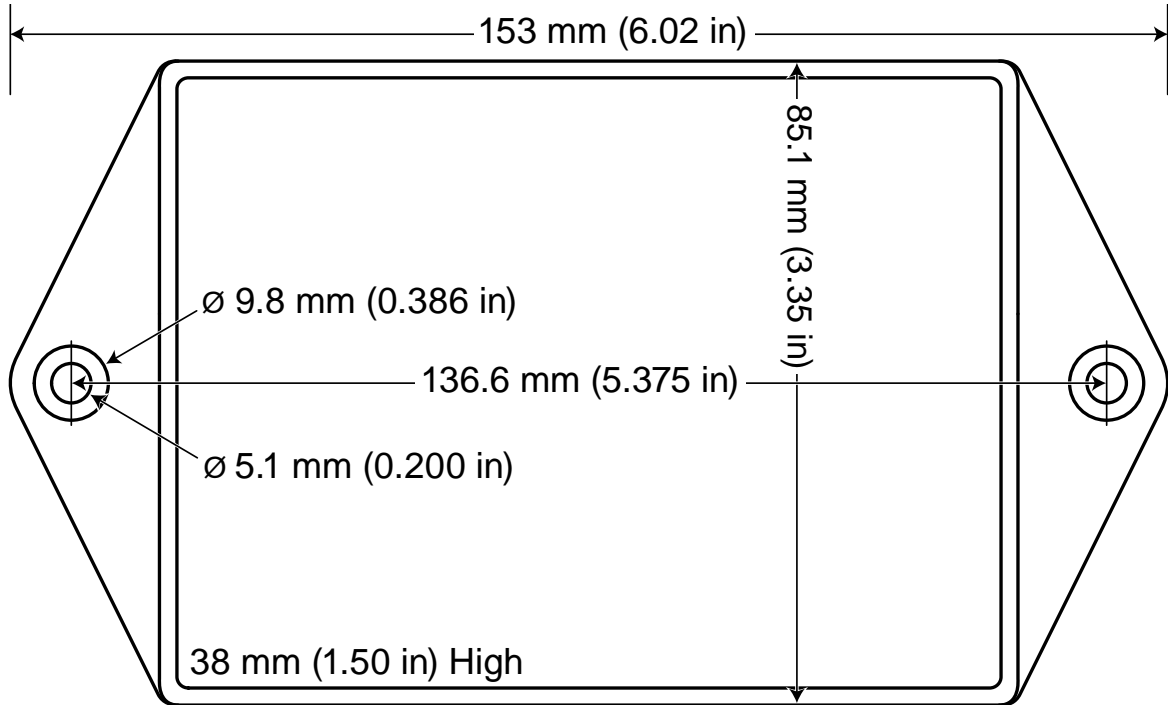

Figure 11: WattNode Meter Dimensions (Drawn to Scale)

The WattNode meter has two mounting holes spaced 5.375 inches (137 mm) apart (center to center). These mounting holes are normally obscured by the detachable screw terminals. Remove the screw terminals by pulling outward while rocking from end to end. The meter or **Figure 11** may be used as a template to mark mounting hole positions, but **do not drill the holes with the meter in the mounting position** because the drill may damage the connectors and leave drill shavings in the connectors.

You may mount the meter with the supplied #8 self-tapping sheet metal screws using 1/8 inch pilot hole (3.2 mm). Or you may use hook-and-loop fasteners. If you use screws, avoid over-tightening which can crack the case. If you do not use the supplied screws, the following sizes should work (**bold** are preferred); use washers if the screws could pull through the mounting holes

Table 2: Mounting Screws

Screw Style	U.S.A. UTS Sizes	Metric Sizes
Pan Head or Round Head	#6, #8, #10	M3.5, M4 , M5
Truss Head	#6 , #8	M3.5 , M4
Hex Washer Head (integrated washer)	#6, #8	M3.5, M4
Hex Head (add washer)	#6, #8 , #10	M3.5, M4 , M5

2.6 Selecting Current Transformers

The WND-series meters can handle a very wide range of current signals, from less than 1% of rated current to over 200%, while maintaining high accuracy. Most modern CTs, with the exception of some lower-cost models using silicon-iron cores, are also accurate over a wide range, commonly from 1% to 120% of rated current. This allows flexibility in selecting the CT rated amps.

The rated full-scale current of the CTs should generally fall in the range between the highest typical current and the rated current for the circuit being monitored. For example, if you are monitoring a motor on a 100 amp circuit and the motor normally draws between 30 and 50 amps, you would be fine using a 50 amp or 100 amp CT.

Take care that the maximum allowable current for the CT can not be exceeded without tripping a circuit breaker or fuse.

For revenue accuracy, use accuracy class 0.3 or 0.2 current transformers to achieve a 0.5% system accuracy or class 0.5 or 0.6 CTs for a 1.0% system accuracy; other CTs are less accurate and may not provide revenue accuracy. Contact sales for more information on appropriate CTs.

We only offer CTs that measure AC current, not DC current. Significant DC current can saturate the CT magnetic core, reducing the AC accuracy. Most loads only have AC current, but some rare loads draw DC current, which can cause measurement errors. See our website for more information: <https://ctlsys.com/s/dc-half-wave-rectified/>.

CTs can measure lower currents than they were designed for by passing the conductor through the CT more than once. For example, to measure currents up to 1 amp with a 5 amp CT, loop the conductor through the CT five times. The CT is now effectively a 1 amp CT instead of a 5 amp CT. The effective current rating of the CT is the labeled rating divided by the number of times that the wire passes through the CT.

With voltage output CTs, you may connect the outputs of CTs of the same model in parallel. This is useful when monitoring services with two or three large conductors (say an 800 amp service with two 500 kcmil conductors), because it allows the use of smaller, less expensive CTs. It is also useful if you wish to combine two or three circuits together for monitoring with one meter. When paralleling CTs, the effective rated amps is the sum of the rated amps of the CTs being connected in parallel. For more information, see <https://ctlsys.com/s/parallel-cts/>.

If you are using the meter elements of the WattNode (V_A , V_B , and V_C) to measure different circuits, you can use CTs with different rated current on the different inputs. Instead of setting one **CtAmps** value for all CTs, you can use different values for each input: **CtAmps1**, **CtAmps2**, and **CtAmps3**.

2.6.1 Approved Current Transformers

The WattNode meter may be used with the following current transformers:

- UL Listed to UL 2808, CSA 61010-2-30 (XOBA/XOBA7), 600 V rated, 0.333 Vac output. This includes, but is not limited to the following:

ACTL-0750-xxx

CTML-0350-xxx

TCL-B-xxx

ACTL-1250-xxx

CTBL-WxL-xxxx

- UL Listed to UL 2808 (XOBA/XOBA7), 600 V, 40 mA output. **The meter must be factory configured to use milliamp output CTs: contact CCS for details.**

TCL-B-100/40mA

- The following UL Recognized CTs. UL Recognized CTs are not for use in panelboards.

ACT-0750-xxx

CTS-2000-xxxx

CTT-1000-xxx

CTL-1250-xxx

CTB-WxL-xxxx

CTT-1250-xxx

CTM-0360-xxx

CTT-0300-xxx

CTRC-yyyyy-xxxx

CTS-0750-xxx

CTT-0500-xxx

CTS-1250-xxx

CTT-0750-xxx

“xxx” indicates the full scale current rating.

“WxL” indicates the opening width (**W**) and leg length (**L**) in inches.

“yyyyy” indicates the diameter of the opening in mils (thousandths of inches).

2.6.2 Current Crest Factor

The term “current crest factor” is used to describe the ratio of the peak current to the RMS current (the RMS current is the value reported by multimeters and the WattNode meter). Resistive loads like heaters and incandescent lights have nearly sinusoidal current waveforms with a crest factor of approximately 1.4. Power factor corrected loads such as electronic lighting ballasts and computer power supplies typically have a crest factor of 1.4 to 1.5. Battery chargers, VFD motor controls, and other nonlinear loads can have current crest factors ranging from 2.0 to 3.0, and even higher.

The WND-series meters can handle crest factor up to 3.5 at rated CT current and 7.0 at 50% of rated CT current. This handles most conceivable loads. In the unlikely event that you have a very high crest factor load that is also near the rated CT current and clipping occurs, the WattNode indicates this by reporting error codes 2000, 2001, or 2002 for **CT1**, **CT2**, and **CT3** inputs respectively (see [ErrorStatus](#) registers). The solution is to select CTs with higher rated current.

2.7 Connecting Current Transformers

2.7.1 Precautions

- To reduce the risk of electric shock, always open or disconnect circuit from power-distribution system or service of the building before installing or servicing current transformers.
- Use only UL Listed or UL Recognized current transformers (CTs). Depending on the meter options, you may use either CTs with built-in burden resistors that generate 0.333 Vac (333 millivolts AC) at rated current or milliamp output CTs that generate up to 40 mA at rated current.
- **Do not use** 1 amp or 5 amp output CTs: they will **destroy** the meter and present a shock hazard! These are commonly labelled with a ratio like 100:5. Also, do not use milliamp output CTs unless the meter was ordered with **Option R** or **Option MA**.
- The CTs are not suitable for Class 2 wiring methods and must be treated as Class 1 wires.
- Secure each current transformer to the conductor or the back panel and route the lead wires so that they do not directly contact live terminals or bus.
- Do not install current transformers where they would: 1) exceed 75 percent of the wiring space of any cross-sectional area within the equipment, 2) would block ventilation openings, or 3) would be in an area of breaker arc venting.
- See our website, the CT datasheets, or the CT label for the maximum input current ratings. Ensure that this is not exceeded under normal use.
- To minimize current measurement noise, try to avoid extending the CT wires beyond 100 feet (30 meters), especially in noisy environments. If it is necessary to extend the wires, use twisted pair wire 18 AWG, rated for 300 V or 600 V (not less than the service voltage) and shielded if possible.

2.7.2 Installation Steps

- CTs are directional. If they are mounted backward or with their white and black wires swapped at the meter, the measured power will be negative. The meter element status LEDs **P_{CT1}**, **P_{CT2}**, and **P_{CT3}** indicate negative measured power by flashing red. Note: reversed CTs can be corrected with the [CtDirections \(1607\)](#) register.
- Find the arrow or label “THIS SIDE TOWARD SOURCE” on the CT and face toward the current source: generally the utility meter or the circuit breaker for branch circuits.

- Pass the conductor to be measured through the CT as shown in the section **2.4 Electrical Service Types**. You may measure generated power by treating the generator as the source.
- For solid-core CTs, disconnect the line voltage conductor to install it through the CT opening.
- Split-core and Rogowski CTs can be opened for installation around a conductor. A nylon cable tie may be secured around split-core CTs to prevent inadvertent opening.
- Some split-core CT models have flat mating surfaces. When installing this type of CT, make sure that mating surfaces are clean. Any debris between the mating surfaces increases the gap, decreasing accuracy.
- Connect the CT lead wires to the meter terminals labeled **CT1**, **CT2**, and **CT3**. Route the twisted black and white wires from the CT to the meter. Strip 1/4 inch (6 mm) of insulation off the ends of the CT leads and connect to the six position black screw terminal block. Connect each CT lead with the white wire aligned with the white dot on the label, and the black wire aligned with the black dot.
- Be careful to match up the current transformers to the voltage phases being measured. Make sure the **CT1** is measuring the line voltage connected to **V_A**, and the same for **V_B** and **V_C**. Use the supplied colored labels or tape to identify the wires. Because the WND-series meters allow reconfiguring the meter elements, you may sometimes intentionally use different configurations: if so, be sure to carefully document the wiring so that the meter can be configured correctly. See **2.3 Metering Theory, MeterConfig1, MeterConfig2, MeterConfig3**, and **ConnectionType** for more information.
- Record the CT rated current and the associated voltage phase as part of the installation record for each meter. If the conductors being measured are passed through the CTs more than once, then the recorded rated CT current is divided by the number of times that the conductor passes through the CT.
- OPTIONAL: if you see spurious readings on unused meter elements, you may jumper the unused CT inputs with a short wire or disable the associated meter element by setting that element's **CtAmps1, CtAmps2, CtAmps3** register to zero: e.g. **CtAmps2** = 0.

2.8 Connecting Voltage Inputs

The WattNode Wide-Range uses the line voltage inputs to power the meter and to sense the line voltages for power and energy measurements.

The voltage inputs to the meter do not need to be powered from the same branch circuit as the load being monitored. In other words, if you have a three-phase panel with a 100 A three-pole breaker powering a motor that you wish to monitor, you can power the meter (or several meters) from a separate 20 A three-pole breaker installed in the same, or even adjacent panel, so long as the load and voltage connections are supplied from the same electric service transformer.

2.8.1 Circuit Protection

The WattNode meter is considered “permanently connected equipment”, because it does not use a conventional power cord that can be easily unplugged. **Permanently connected equipment must have overcurrent protection (fuse or circuit breaker) and a disconnect means (disconnect switch or circuit breaker).**

- The disconnect or circuit breaker must be clearly marked, suitably located, and easily reached. It should have at least a 1 amp rating and must be rated for the line voltage.
- Use circuit breakers or fuses rated for 20 amps or less, and rated for the service voltage and the current interrupting rating required.
- Use ganged circuit breakers when monitoring more than one line voltage.
- The circuit breakers or fuses must protect whichever of the line voltage terminals **V_A**, **V_B**, or **V_C** are connected to the meter. Neutral does not need overcurrent protection.
- The circuit protection / disconnect system must meet IEC 60947-1 and IEC 60947-3, as well as all national and local electrical codes.

- The WattNode meter has an earth connection, which should be connected for maximum accuracy. However, this earth connection is not used for safety (protective) earthing.

2.8.2 Line Wiring

- **Always turn off the line voltage source** before connecting the line voltages to the meter.
- For the line voltage conductors, CCS recommends 18 to 12 AWG stranded wire, type THHN, MTW, or THWN, 600 V. Solid wire may be used, but must be routed carefully to avoid putting excessive stress on the screw terminal blocks.
- **Use copper conductors only.** The screw terminals are only rated for copper wire.
- Do not place more than one wire in a screw terminal; use wire nuts or distribution terminal blocks if needed.
- Strip the wires to expose 1/4" (6 mm) of bare copper.

The screw terminals handle wire up to 12 AWG. Connect each voltage conductor to the green terminal block (voltage inputs) as shown in **Figure 2: General Wiring Diagram** and figures 3 through 8 above. Connect ground and connect neutral if applicable. After connecting the voltage conductors, make sure the terminal block is fully seated in the meter.

2.8.3 Grounding

The WattNode meter uses a plastic enclosure, insulation, and internal isolation barriers instead of protective earthing. The ground terminal on the green screw terminal block is a functional ground, designed to improve the measurement accuracy and noise immunity. If necessary, this terminal may be left disconnected.

2.9 Connecting Modbus Outputs

The Modbus WattNode meter communicates using a serial EIA RS-485 interface. The meter uses half-duplex two-wire (plus common) communication, so the same pair of wires is used for sending AND receiving.

Up to 247 devices (63 if using the DIP switch to set the address) can be connected together on the same RS-485 bus, provided they have a receiver bus load no higher than 1/8 unit load, like the WattNode.

- Be sure to connect the **A-**, **B+**, and **C** (common) terminals. It is important to connect the common (**C**) terminal for reliable communication. The earth ground connection on the meter is isolated from the communication interface, so the earth ground connection does not provide a common connection for RS-485 communication.
- If you are using shielded cable, you may use the shield to provide the Modbus common "**C**" connection between all devices on the network.
- Connect the cable shield or Modbus common (if there is no shield) to earth ground at just the Modbus master end of the cable. Grounding both ends can cause ground loops. Leaving the common floating risks damaging the RS-485 circuitry.
- For long distances, use a shielded twisted-pair cable to prevent interference. With a shielded cable, connect the shield to earth ground at the Modbus master.
- The Modbus terminals (**A-**, **B+**, **C**, and **X**) are completely isolated (4500 Vac RMS isolation) from dangerous voltages.
- You may put two sets of wires in each screw terminal to make it easier to daisy-chain the network from one device to the next. If you do this, we recommend that you twist the wires tightly together before putting them into the screw terminal to ensure that one wire does not pull free.

2.9.1 RS-485 Cable

EIA RS-485 networks should always be wired in a bus (or daisy-chain) configuration. In other words, the bus should start at the Modbus master, PC, or monitoring device and then run to each

meter in turn. Connect or daisy-chain all “A-” terminals together, all “B+” terminals together, and all “C” (common) terminals together.

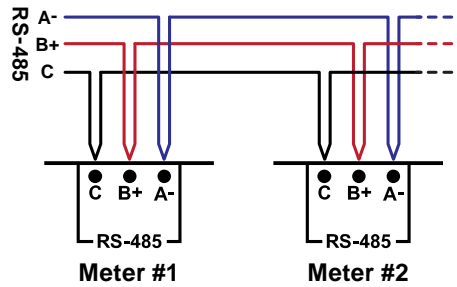

Figure 12: RS-485 Daisy-Chain Connections

Try to avoid branches, and avoid home-run wiring (where each meter has its own wire back to the Modbus master). For best results, especially for longer distances, use wire recommended for RS-485.

Table 3: Recommended RS-485 Cabling

Manufacturer	Part Number	AWG	Pairs	Shielded?	Impedance	Insulation
Belden	9841	24	1	Yes	120 ohms	300 V
Carol	C2536A	22	1	Yes	not spec.	600 V
many	CAT 5, 5e	24	4	Optional	100 ohms	300 V
many	CAT 6	23 or 24	4	Optional	100 ohms	300 V

- Since the Modbus / RS-485 wiring may be located near line voltage wiring, use wires or cables rated for the highest voltage present, generally 300 V or 600 V rated wire.
- If this cable is in the presence of bare conductors, such as bus bars, it should be double insulated or jacketed.
- Use twisted-pair cable (unshielded or shielded) to prevent interference.

2.9.2 RS-485 Length Limits

Under ideal conditions, using cable with a 120 ohm impedance and proper termination, it should be possible to run RS-485 signals 1200 m (4000 ft) at up to 19,200 baud. However, a number of factors can reduce this range, including electrical and magnetic interference (EMI), bus loading, poor termination, etc. Repeaters are available to extend the range if necessary.

2.9.3 RS-485 Termination

Short networks should not need termination, especially at lower baud rates. Longer networks and networks in electrically noisy environments may need termination at both ends of the bus of 120 ohms between the “A-” and “B+” terminals. Generally, terminate at the Modbus master and at the meter farthest from the monitoring device. See [Table 4](#) below for recommended RS-485 network lengths for unterminated and terminated networks.

Some EIA RS-485 PC interfaces include jumpers or switches to provide internal termination at one end of the bus.

In some cases, termination can cause problems. It dramatically increases the load on the bus, so that some RS-485 PC interfaces cannot handle the load (particularly port powered ones). Also, adding termination generally requires the addition of bias resistors (see [2.9.5 RS-485 Biasing](#) below).

Table 4: RS-485 Termination vs. Baud Rate

Baud Rate	Maximum Unterminated Length (m)	Maximum Unterminated Length (ft)	Maximum Terminated Length (m)	Maximum Terminated Length (ft)
9600	860	2822	1220	4000
19200	430	1411	1220	4000
38400	215	705	1220	4000
57600	140	459	1220	4000
76800	105	344	1220	4000
115200	70	230	990	3250

2.9.4 WattNode Internal Termination

The WattNode Wide-Range uses DIP switch 7 to internally connect (ON) or disconnect (OFF) a 120 Ω termination resistor between the **A-** and **B+** terminals. By default (as shipped), the termination is disconnected.

Remember that only the two endpoints of an RS-485 network should include termination resistors. If you have more than two devices with termination, it may overload the network!

The WattNode meter does not provide RS-485 biasing, since this is normally provided by the Modbus master device.

2.9.5 RS-485 Biasing

EIA RS-485 networks frequently use bias resistors to hold the bus in a “high” or logic 1 state when no devices are transmitting. In this state, the Modbus “**A-**” terminal is more negative than the “**B+**” terminal. Without bias resistors, the bus can float and electrical noise can appear as bogus data.

The WattNode meter uses an RS-485 failsafe transceiver that eliminates the need for bias resistors except in noisy environments. Furthermore, many Modbus master devices, such as RS-485 gateways and PC interfaces, include internal bias resistors, so it is rare to need to add bias resistors.

If you determine that your network is experiencing noise problems, then you may want to enable termination and possibly add bias resistors.

2.10 Configure Modbus Settings

Every device on a Modbus network must have a unique address and the correct baud rate. The WattNode meter sets common addresses and baud rates with an eight position DIP switch. For less common configurations, see **4.5 Communication Configuration**. It is also possible to order the meter with options to factory program the desired communication configuration: see **1.5.2 Communication Options**.

2.10.1 Setting the Modbus Address

The WattNode meter supports Modbus addresses from 1 to 63 using the DIP switch. Address 0 is used for broadcast messages and is not a valid address. As shipped from the factory, the DIP switch is set to an address of 0, which is invalid. This prevents the meter from responding to Modbus messages, and causes the “**Com**” LED to light solid red. Even when set to address 0, the meter still processes broadcast messages. This feature can be used to assign a non-zero Modbus address.

Red

Set the Modbus address by switching DIP switch positions 1-6, each of which adds a different value to the address. The change takes effect immediately.

Table 5: Modbus Address Selection

DIP Switch	1	2	3	4	5	6
Up (1) Value	1	2	4	8	16	32
Address	Examples					
1	Up	Down	Down	Down	Down	Down
1+2+4 = 7	Up	Up	Up	Down	Down	Down
4+16 = 20	Down	Down	Up	Down	Up	Down
1+2+16+32 = 51	Up	Up	Down	Down	Up	Up

For example, if DIP switch positions 3 and 5 are in the 1 (up) position and the rest are 0 (down), the resulting Modbus address is 4 + 16 = 20.

Once you are communicating with the meter, you can change the address using the DIP switches, the **Address (1652)** register, or the broadcast command registers **SerialNumberKey (1657, 1658)** and **NewAddress (1659)**.

2.10.2 Option AD Notes

The WattNode meter can be ordered from the factory with the Modbus address pre-programmed to any value from 1 to 247 using **Option AD=xxx** where **xxx** is the desired address. If you want to change the address of a meter with Option AD, there are two options:

- 1) **Set the address with the DIP switch:** Set the DIP switches to the desired address, then write 0 to the **Address (1652)** register (to override the factory programmed address). Finally, write 1234 to the **ApplyComConfig (1651)** register to apply the new address.
- 2) **Set the address with the Address register:** Set the DIP switches to any non-zero address so the meter does not reset the address to the factory programmed value. Next write the new address to the **Address (1652)** register. Finally, write 1234 to the **ApplyComConfig (1651)** register to apply the change.

2.10.3 Setting the Baud Rate

Select the baud rate by setting DIP switch position 8 as shown below; the change takes effect immediately.

Table 6: Baud Rate Selection

Baud Rate	DIP Switch Position 8
9,600 (default)	0 (down)
19,200	1 (up)

The baud rate can be programmed with a factory option (see **1.5.2 Communication Options**) or with the **BaudRate** register (see **4.5 Communication Configuration**) to set the baud rate from 1,200 to 115,200 baud. In either of these cases, the DIP switch 8 has no effect.

2.10.4 Setting the Parity and Stop Bits

The WattNode supports the following parity and stop bit combinations:

- 0 = (default) 8N1, eight data bits, no parity, one stop bit.
- 1 = 8E1, eight data bits, even parity, one stop bit. **Option EP**
- 2 = 8N2, eight data bits, no parity, two stop bits. **Option 8N2**

When ordering the WattNode, if you need 8E1 or 8N2, specify these with **Option EP** or **Option 8N2**. These options are printed on the front label:

To change the parity and stop bits in the field, write the value (0, 1, or 2) to the **ParityMode (1654)** register, then write 1234 to the **ApplyComConfig (1651)** register to apply the change.

2.10.5 Reset Communication Settings

Setting all DIP switch positions to zero for ten seconds resets all communication settings to the factory configuration. If you ordered communication options like **Option EP**, the options are reapplied when you reset the options to factory defaults. This is useful if you cannot communicate and need to return the meter to a known state.

2.11 Apply Power

Once all the connections are complete and the DIP switches have been set correctly, you may apply AC power to the meter. You should see the LEDs go through the startup sequence.

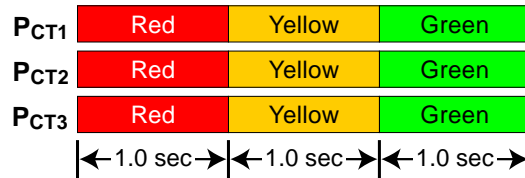

Figure 13: LED Startup Sequence

After startup, the power LEDs always display some pattern so long as the meter is operating correctly. See [6 LED Indications and Troubleshooting](#) for more information or to troubleshoot any problem.

3 Operating Instructions

3.1 Quick Start

To start communicating with a WattNode meter using a PC, you'll need to complete the following steps. You may also do this testing with a Modbus gateway or other Modbus master device, but the details may vary.

- Note any communication options, such as baud rate, Modbus address, or parity from the front label options or from the packing list. See [1.5.2 Communication Options](#).
- Set the Modbus address and baud rate using the DIP switches (see [2.10 Configure Modbus Settings](#)).
- Find and install Modbus software for your PC. For a list of some low-cost programs, see https://ctlsys.com/support/modbus_software/.
- Find and install an EIA RS-485 interface for your PC. The most common are RS-485 USB interfaces (Ethernet, PCI, and RS-485 to RS-232 adapters are also available). The RS-485 USB interfaces are generally the best choice, because they are USB powered and do not require a serial port on your PC.
- Configure your Modbus software for the correct baud rate, COM port, Modbus RTU (not Modbus ASCII), N81 parity (no parity, eight data bits, one stop bit), and the WattNode meter's Modbus address. If you have ordered **Option EP**, then use even parity (E81) instead.

Now you should be able to send commands to the WattNode meter and receive responses. As a test, try reading the integer frequency register at register address **1221**. Be sure to request only one register: some software defaults to reading 100 register blocks, which will cause a Modbus exception. You should see the actual AC line frequency multiplied by 10 (approximately 600 for 60 Hz power). If you do not get a good response, check the section [6.3 Modbus Communication Diagnostics](#).

3.1.1 WattNode Basic Configuration

- Set the **CtAmps (1603)** register to the correct rated CT amps of your current transformers. For example, if you are using 100 A CTs, write 100 to register **1603** (16-bit integer register).
- If you are planning on using demand measurements and you do not want to use the default 15 minute interval, you should set the **DemPerMins** as well.

3.1.2 Verify Operation

You should be able to read several registers to check that the meter is correctly installed and measuring power and energy. If your Modbus software supports floating-point Modbus registers, you may want to read from the set [4.2.5 Measurement Register List - Floating-Point](#). If you cannot easily read floating-point values, use [4.2.6 Measurement Register List - Integer](#) instead. Verify registers in the following sequence:

- **Freq (power line frequency)**: should be near 50 or 60 Hz (or 500 or 600 if you are reading the integer registers).
- **VoltAN, VoltBN, VoltCN**: should match your line-to-neutral voltage.
- **Power1, Power2, Power3**: should be positive (unless you are measuring something that can generate power like a PV system) and in a reasonable range for the load being measured (make sure your load is ON). Note: the integer power registers are scaled, so if you expect to see 75,000 W (75 kW) and instead you see 7500, that is probably because the meter is reporting integer power in 10 W increments. See [PowerIntScale](#) for details.
- **ErrorStatus**: this returns 0 if there are no errors. If you see any non-zero values, write them down and check the [4.9 Errors](#) section below to determine the problem.

If you are measuring floating-point values and the numbers are way off, your software may be combining the floating-point registers in the wrong order. Compare the values to the integer

registers and check to see if your software has an option like “Float - swapped” or “Float - reversed”; if so, see if this fixes the problem.

- If you do not get reasonable results, check [6.2 Measurement Troubleshooting](#) above.

3.1.3 Measurement Overview

The WattNode meter performs measurements every 100 milliseconds. The measurements are used to update three types of registers:

- **Energy registers:** These accumulate up (or sometimes down) based on the consumed energy during each measurement period. Energy values are preserved across power failures. The energy registers are only updated once a second.
- **Instantaneous registers:** These are non-accumulating values, like power, volts, current, power factor, frequency, etc. These are not preserved across power failures. These update ten times per second, but are generally configured with some averaging (the default is five seconds), so the values change more smoothly.
- **Demand registers:** these accumulate data from each measurement, but the reported demand values only update at the completion of a demand interval (or subinterval), which is typically every 15 minutes. Only the peak demand values are preserved across power failures.

3.2 Maintenance and Repair

The WattNode meter requires no maintenance. There are no user serviceable or replaceable parts except the pluggable screw terminals.

The WattNode meter should not normally need to be cleaned, but if cleaning is desired, power must be disconnected first and a dry or damp cloth or brush should be used.

The WattNode meter is not user serviceable. In the event of any failure, the meter must be returned for service (contact CCS for an RMA). In the case of a new installation, follow the diagnostic and troubleshooting instructions before returning the meter for service, to ensure that the problem is not connection related.

4 Modbus Interface and Registers

4.1 Modbus Overview

The Modbus protocol is a master/slave protocol, with only one master and many slaves. The WattNode meter is always a slave device, and responds only when queried.

Modbus on EIA RS-485 allows for either full-duplex or half-duplex communication, but the WattNode meter only supports half-duplex, meaning that the same wires are used both for transmitting and receiving and only one device can be transmitting at a time. To avoid conflicts (two devices trying to transmit at the same time), the Modbus protocol only allows the master to initiate a request. After the master has finished transmitting, if the meter has received a valid packet addressed for it, then the meter transmits its response.

The WattNode meter uses Modbus RTU communication. For full specifications, see <http://www.modbus.org/specs.php>. Modbus RTU is a binary protocol consisting of message frames. Each frame contains a one byte address, a one byte function code, a variable number of data bytes, and a two byte CRC. The end of a frame is signalled by a pause with no bytes transmitted; the pause duration must be at least equivalent to 3.5 character (byte) periods. At 9600 baud the pause must last 3.6 milliseconds.

The Modbus RTU serial specification requires that the default serial protocol use 8 data bits, even parity, and one stop bit. However, very few devices follow this part of the Modbus standard, so the WattNode meter defaults to 8 data bits, no parity, and one stop bit instead. If your application requires even parity, order **Option EP** or change the parity using the **ParityMode** register.

4.1.1 Modbus Functions

In most cases, your Modbus software automatically uses the correct Modbus command for any action you wish to perform, so you may be able to skip this section. The Modbus specifications list numerous possible commands, but the WattNode meter only supports the following:

- **03 (0x03) - Read Holding Registers:** Holding registers can be read and written and are intended for configuration values, but the WattNode meter treats input registers and holding registers interchangeably, so you can use functions 04 or 03 to read any registers.
- **04 (0x04) - Read Input Registers:** Input registers are generally read-only and report power, energy, and related values. The WattNode meter treats input registers and holding registers as interchangeable, so you can use functions 04 or 03 to read any registers.
- **06 (0x06) - Write Single Register:** This writes a new value to a single register.
- **16 (0x10) - Write Multiple Registers:** This writes a new value to a range of registers.
- **17 (0x11) - Report Slave ID:** This returns a packet containing an ASCII text identification string. See the next section for details.

Trying to use other Modbus functions will result in Modbus exception **01 - Illegal Function Code**. See [4.9.1 Modbus Exceptions](#).

4.1.2 Report Slave ID

The report slave ID function returns the following standard packet:

Table 7: Report Slave ID Response

Name	Length	Value	Description
Address	1 byte	Varies	Modbus Address of the meter
Function Code	1 byte	0x11	Report Slave ID function code
Byte Count	1 byte	Varies	Number of bytes in Slave ID, Run Indicator Status, and Additional Data
Slave ID	1 byte	0x04	WattNode meter Slave ID byte
Run Indicator Status	1 byte	0xFF = ON	Always returns 0xFF
Additional Data	Variable, typically 64	ASCII string, null terminated	“Continental Control Systems LLC, WattNode MODBUS, WND-WR-MB”
CRC	2 bytes	Varies	Packet checksum

4.1.3 Firmware Field Upgrade

The WND-series Modbus WattNode meters, including the WattNode Wide-Range, support firmware upgrades using the Modbus RTU protocol. However, the field upgrade process is rarely necessary and requires custom software. Contact CCS for details.

4.2 Modbus Registers

The Modbus registers are grouped as follows, with detailed information in the following sections.

- **Measurement Registers:** Floating-point
- **Measurement Registers:** Integer
- **Configuration Registers:** Integer
- **Customer Diagnostic Registers:** Integer
- **Option Information Registers:** Integer
- **Custom Register Map**

In addition to these registers, the WattNode meter also includes the SunSpec register models. See **5 SunSpec Interface and Registers** for details.

4.2.1 Modbus Register Addressing

There are a few points about Modbus register addressing that can cause confusion.

- In the Modbus specification, register numbers are documented as “one based”, but transmitted as “zero based”. For example, we document that **EnergySum** appears at address **1001**. If you are using any Modbus software or Modbus aware device, you should use “1001” as the register address. However, if you are writing your own low-level Modbus driver or firmware, you must subtract one from the register number when creating the Modbus frame (or packet), so the actual register number that appears on the RS-485 bus is “1000” (or in hexadecimal, 0x03E8).
- An older Modbus convention adds the Modbus function code as a leading digit on the register number, so a register like **EnergySum (1001)** would be documented as **41001**. All input registers (function code 04) would use the form **4xxxx**, while holding registers (function code 03) would use the form **3xxxx**. The WattNode meter treats holding registers and input registers interchangeably, and does not use this convention, in part because it would conflict with the SunSpec register numbers. If your Modbus software expects a leading “3” or “4”, either will work for most registers, but use “3” for configuration registers.
- The register names are not used for communication. You can choose different names or just use the register numbers if desired.

4.2.2 Floating-Point and Integer Registers

Most registers are available in floating-point and integer formats. We generally recommend using the floating-point registers, because they provide more resolution and dynamic range and they never requiring scaling. However, for energy variables, the 32-bit integer registers may be a better choice, because they provide a constant resolution of 0.1 kWh. Since most of the integer registers are 16 bits, they are faster to transfer over the Modbus interface and may require less space if they are being logged.

Most of the integer registers are 16-bit signed integers that can report positive or negative values from -32,768 to +32,767. In a few special cases, such as the energy registers, we use 32-bit signed integer registers (sometimes called “long integer”), which use two adjacent Modbus registers and can report values up to approximately \pm two billion.

Floating-point values can report positive or negative values with typically six or seven significant digits, which is far higher than the WattNode meter’s accuracy. However, for energy measurements (kWh), floating-point values have a limitation: the effective resolution in kWh gets lower as more energy accumulates. If the total energy exceeds 100,000 kWh, the resolution of the floating-point energy becomes coarser than 0.1 kWh, the constant resolution of the integer energy values. At a total energy of 1,000,000 kWh, the floating-point energy resolution becomes 1.0 kWh.

4.2.3 Reading and Writing 32-bit Registers

Since floating-point and 32-bit long integer registers require two adjacent registers to store 32 bits, there are some things to note when reading and writing these 32-bit dual registers:

- **Little-endian:** The standard WattNode Modbus 32-bit registers are little-endian. The first register (at the lower address) contains the least significant 16 bits of data. This is the default for many programs that read 32-bit Modbus values, but if this results in strange values (very large, very small, or invalid), look for an option to reverse the registers, commonly referred to as “Float - Swapped”, “Float - Reversed”, “Long - Swapped”, etc. Tridium JACE® systems refer to this as “byte order 1032”. Do not select 64-bit double precision formats.
- **Big-endian:** The SunSpec 32-bit registers are big-endian, where the first register contains the most significant 16 bits of data.
- **Single-read:** When reading a 32-bit register, read both registers with a single Modbus read command. The WattNode meter is guaranteed to return consistent results for a single multiple register read command. If you (or your software) issues two separate read commands for the two registers making up a 32-bit register, the underlying 32-bit register may be updated between the two read commands, resulting in an inconsistent or scrambled value.
- **Write-multiple:** When writing to 32-bit registers, the recommended approach is to use the **Write Multiple Registers (16)** command to update both registers at the same time. However, the meter incorporates logic to allow two **Write Single Register (06)** commands within 30 seconds, provided no other Modbus commands are issued between the two writes.

For more information on Modbus register formats, floating-point, programming, etc., see <https://ctlsys.com/cat/wattnode-modbus/>.

4.2.4 Register Changes from the WNC to the WND Series

The WattNode Wide-Range is a WND-series product that includes several changes to the registers. For full details, see the descriptions for each register.

- Support was added for the following SunSpec models. See **5 SunSpec Interface and Registers** for details.
 - Model 1: common
 - Model 203: wye-connected three-phase meter with integer outputs
 - Model 213: wye-connected three-phase meter with floating-point outputs
 - Model 64080: Continental Control Systems vendor model for WND-series meters

- Support was added for disconnected CT detection using the registers: **CtMonitoring** and **CtStatus1, CtStatus2, CtStatus3**.
- Instead of labeling registers as **PowerA**, **PowerB**, and **PowerC**, they are now labeled **Power1**, **Power2**, and **Power3**. The register numbers are unchanged, so any system that works with a WNC-series meter will continue to work fine with a WND-series meter. In the WNC series of meters, the phase A CT is hardwired to the phase A voltage input, so it made sense to label the voltage input, the CT, and the registers with “A”. In the WND series of meters, meter element 1 (containing CT1) may be configured with V_{AN} , V_{BN} , V_{CN} , V_{BC} , etc., so it no longer makes sense to refer to the CT as “**ΦA CT**”. For example, it could be confusing if **PowerA** was measuring the power from CT1 with the voltage on phase B (V_{BN}).
- In the manual, the registers were grouped into basic and advanced groups, but now are combined into measurement registers. The register numbers are not affected, this is just a change in the way they are documented. There are still separate groups for the floating-point and integer measurement registers.
- The WNC series of meters has an option to provide fast power readings. The floating-point fast power readings are standard on the WND series of meters and appear as **SecondsFast**, **PowerFastSum**, **PowerFast1**, **PowerFast2**, and **PowerFast3**.
- The WNC series of meters measured the fundamental reactive power and energy, while WND-series meters measure the fundamental and harmonics for reactive power and energy (Budeanu reactive power and energy). Registers were added for positive and negative reactive energy, in addition to the existing net reactive energy registers.
- The WNC series of meters measured the fundamental or displacement power factor while the WND-series meters measure the apparent power factor, which includes harmonics.
- **VoltAC** was renamed to **VoltCA** (the measurement is not changed).
- The WNC meters report signed (positive or negative) current values, where the sign of the current matches the sign of the active power. The WND meters can be configured (see **OptSignedCurrent**) for signed or unsigned current, with unsigned as the default.
- The WNC series of meters estimated the line-to-line voltage measurements (**VoltAB**, **VoltBC**, and **VoltCA**) based on the line-to-neutral voltages and the **PhaseOffset** configuration register. The WND series of meter directly measure the line-to-line values with high accuracy. The **PhaseOffset** register value is ignored.
- The demand registers **Demand**, **DemandMin**, **DemandMax**, and **DemandApp** were renamed to **DemandSum**, **DemandSumMin**, **DemandSumMax**, and **DemandAppSum**, respectively.
- The units and behavior of the **CreepLimit** configuration register was updated and a voltage noise floor register was added (see **VoltsNoiseFloor**).
- The underlying measurement update rate was changed from once per second to once per 100 milliseconds.
- The **Averaging** register was updated to allow averaging periods of less than one second.
- The WND-series meters add the following configuration registers: **MeterConfig1**, **MeterConfig2**, **MeterConfig3**, **ChangeCounter**, **NominalCtVolts1**, **NominalCtVolts2**, **NominalCtVolts3**, **ConnectionType**, **VoltsNoiseFloor**, **PtRatio**, **OptSignedCurrent**, and **OptEnergySumMethod**.
- The error codes are changed. See **4.9 Errors**.
- Registers were added to change the meter’s Modbus address using a broadcast address containing the serial number of the meter and the new address. See **SerialNumberKey**.
- A special mode was added to allow firmware upgrades over the Modbus interface using a signed, encrypted firmware image. See **4.1.3 Firmware Field Upgrade**.

4.2.5 Measurement Register List - Floating-Point

The following registers provide the measurements in floating-point units. See <https://ctlsys.com/s/float-registers-wattnode-modbus/> for detailed information. **Note:** the register numbers are not in order in the following table.

Registers	Name	Units	Description
Energy Registers			
1001, 1002	EnergySum*†	kWh	Total net (bidirectional) energy
1005, 1006	EnergySumNR*	kWh	Total net energy - non-resettable
1101, 1102	Energy1*†	kWh	Net (bidirectional) energy, meter element 1
1103, 1104	Energy2*†	kWh	Net (bidirectional) energy, meter element 2
1105, 1106	Energy3*†	kWh	Net (bidirectional) energy, meter element 3
1003, 1004	EnergyPosSum*†	kWh	Total positive energy
1007, 1008	EnergyPosSumNR*	kWh	Total positive energy - non-resettable
1107, 1108	EnergyPos1*†	kWh	Positive energy, meter element 1
1109, 1110	EnergyPos2*†	kWh	Positive energy, meter element 2
1111, 1112	EnergyPos3*†	kWh	Positive energy, meter element 3
1113, 1114	EnergyNegSum*†	kWh	Total negative energy
1115, 1116	EnergyNegSumNR*	kWh	Total negative energy - non-resettable
1117, 1118	EnergyNeg1*†	kWh	Negative energy, meter element 1
1119, 1120	EnergyNeg2*†	kWh	Negative energy, meter element 2
1121, 1122	EnergyNeg3*†	kWh	Negative energy, meter element 3
Power Registers			
1009, 1010	PowerSum	W	Total active power
1011, 1012	Power1	W	Active power, meter element 1
1013, 1014	Power2	W	Active power, meter element 2
1015, 1016	Power3	W	Active power, meter element 3
1035, 1036	SecondsFast	seconds	Seconds for last 24 hours, updates at 10 Hz. Rolls over at 86400.
1037, 1038	PowerFastSum	W	Total active power, 10 Hz update, no averaging
1039, 1040	PowerFast1	W	Active power, meter element 1, 10 Hz update, no averaging
1041, 1042	PowerFast2	W	Active power, meter element 2, 10 Hz update, no averaging
1043, 1044	PowerFast3	W	Active power, meter element 3, 10 Hz update, no averaging
Reactive and Apparent Energy Registers			
1123, 1124	EnergyReacSum*†	kVARh	Total reactive energy
1125, 1126	EnergyReac1*†	kVARh	Net reactive energy, meter element 1
1127, 1128	EnergyReac2*†	kVARh	Net reactive energy, meter element 2
1129, 1130	EnergyReac3*†	kVARh	Net reactive energy, meter element 3
1189, 1190	EnergyReacPosSum*†	kVARh	Total positive reactive energy
1183, 1184	EnergyReacPos1*†	kVARh	Positive reactive energy, meter element 1
1185, 1186	EnergyReacPos2*†	kVARh	Positive reactive energy, meter element 2
1187, 1188	EnergyReacPos3*†	kVARh	Positive reactive energy, meter element 3
1197, 1198	EnergyReacNegSum*†	kVARh	Total negative reactive energy
1191, 1192	EnergyReacNeg1*†	kVARh	Negative reactive energy, meter element 1
1193, 1194	EnergyReacNeg2*†	kVARh	Negative reactive energy, meter element 2
1195, 1196	EnergyReacNeg3*†	kVARh	Negative reactive energy, meter element 3

Registers	Name	Units	Description
1131, 1132	EnergyAppSum*†	kVAh	Total apparent energy
1133, 1134	EnergyApp1*†	kVAh	Apparent energy, meter element 1
1135, 1136	EnergyApp2*†	kVAh	Apparent energy, meter element 2
1137, 1138	EnergyApp3*†	kVAh	Apparent energy, meter element 3

Reactive and Apparent Power Registers

1147, 1148	PowerReacSum	VAR	Total reactive power
1149, 1150	PowerReac1	VAR	Reactive power, meter element 1
1151, 1152	PowerReac2	VAR	Reactive power, meter element 2
1153, 1154	PowerReac3	VAR	Reactive power, meter element 3
1155, 1156	PowerAppSum	VA	Total apparent power
1157, 1158	PowerApp1	VA	Apparent power, meter element 1
1159, 1160	PowerApp2	VA	Apparent power, meter element 2
1161, 1162	PowerApp3	VA	Apparent power, meter element 3

Voltage Registers

1017, 1018	VoltAvgLN	V	Average line-to-neutral voltage
1019, 1020	VoltAN	V	RMS voltage, phase A to neutral
1021, 1022	VoltBN	V	RMS voltage, phase B to neutral
1023, 1024	VoltCN	V	RMS voltage, phase C to neutral
1025, 1026	VoltAvgLL	V	Average line-to-line voltage
1027, 1028	VoltAB	V	RMS voltage, line-to-line, phase A to B
1029, 1030	VoltBC	V	RMS voltage, line-to-line, phase B to C
1031, 1032	VoltCA	V	RMS voltage, line-to-line, phase C to A

Current Registers

1163, 1164	Current1	A	RMS current, CT1
1165, 1166	Current2	A	RMS current, CT2
1167, 1168	Current3	A	RMS current, CT3

Frequency Register

1033, 1034	Freq	Hz	Power line frequency
------------	------	----	----------------------

Power Factor Registers

1139, 1140	PowerFactorAvg		Power factor, average
1141, 1142	PowerFactor1		Power factor, meter element 1
1143, 1144	PowerFactor2		Power factor, meter element 2
1145, 1146	PowerFactor3		Power factor, meter element 3

Demand Registers

1169, 1170	DemandSum	W	Active power sum demand averaged over the demand period
1171, 1172	DemandSumMin*	W	Minimum power sum demand
1173, 1174	DemandSumMax*	W	Maximum power sum demand
1175, 1176	DemandAppSum	W	Apparent power sum demand
1177, 1178	Demand1	W	Active power demand, meter element 1
1179, 1180	Demand2	W	Active power demand, meter element 2
1181, 1182	Demand3	W	Active power demand, meter element 3

*These registers are preserved across power failures.

†These registers support presetting the value or resetting it to zero.

4.2.6 Measurement Register List - Integer

The following registers provide the measurements in integer units. The energy registers are 32-bit signed integer values, which require two registers, the first register provides the lower 16 bits, and the second register provides the upper 16 bits of the 32-bit value. All the other values are 16-bit integer values. **Note:** the register numbers are not in order in the following table.

Registers	Name	Units	Description
Energy Registers			
1201, 1202	EnergySum*†	0.1 kWh	Total net (bidirectional) energy
1205, 1206	EnergySumNR*	0.1 kWh	Total net energy - non-resettable
1301, 1302	Energy1*†	0.1 kWh	Net energy, meter element 1
1303, 1304	Energy2*†	0.1 kWh	Net energy, meter element 2
1305, 1306	Energy3*†	0.1 kWh	Net energy, meter element 3
1203, 1204	EnergyPosSum*†	0.1 kWh	Total positive energy
1207, 1208	EnergyPosSumNR*	0.1 kWh	Total positive energy - non-resettable
1307, 1308	EnergyPos1*†	0.1 kWh	Positive energy, meter element 1
1309, 1310	EnergyPos2*†	0.1 kWh	Positive energy, meter element 2
1311, 1312	EnergyPos3*†	0.1 kWh	Positive energy, meter element 3
1313, 1314	EnergyNegSum*†	0.1 kWh	Total negative energy
1315, 1316	EnergyNegSumNR*	0.1 kWh	Total negative energy - non-resettable
1317, 1318	EnergyNeg1*†	0.1 kWh	Negative energy, meter element 1
1319, 1320	EnergyNeg2*†	0.1 kWh	Negative energy, meter element 2
1321, 1322	EnergyNeg3*†	0.1 kWh	Negative energy, meter element 3
Power Registers			
1209	PowerSum	PowerIntScale	Total active power
1210	Power1	PowerIntScale	Active power, meter element 1
1211	Power2	PowerIntScale	Active power, meter element 2
1212	Power3	PowerIntScale	Active power, meter element 3
Reactive and Apparent Energy Registers			
1323, 1324	EnergyReacSum*†	0.1 kVARh	Total reactive energy
1325, 1326	EnergyReac1*†	0.1 kVARh	Net reactive energy, meter element 1
1327, 1328	EnergyReac2*†	0.1 kVARh	Net reactive energy, meter element 2
1329, 1330	EnergyReac3*†	0.1 kVARh	Net reactive energy, meter element 3
1370, 1371	EnergyReacPosSum*†	0.1 kVARh	Total positive reactive energy
1364, 1365	EnergyReacPos1*†	0.1 kVARh	Positive reactive energy, meter element 1
1366, 1367	EnergyReacPos2*†	0.1 kVARh	Positive reactive energy, meter element 2
1368, 1369	EnergyReacPos3*†	0.1 kVARh	Positive reactive energy, meter element 3
1378, 1379	EnergyReacNegSum*†	0.1 kVARh	Total negative reactive energy
1372, 1373	EnergyReacNeg1*†	0.1 kVARh	Negative reactive energy, meter element 1
1374, 1375	EnergyReacNeg2*†	0.1 kVARh	Negative reactive energy, meter element 2
1376, 1377	EnergyReacNeg3*†	0.1 kVARh	Negative reactive energy, meter element 3
1331, 1332	EnergyAppSum*†	0.1 kVAh	Total apparent energy
1333, 1334	EnergyApp1*†	0.1 kVAh	Apparent energy, meter element 1
1335, 1336	EnergyApp2*†	0.1 kVAh	Apparent energy, meter element 2
1337, 1338	EnergyApp3*†	0.1 kVAh	Apparent energy, meter element 3
Reactive and Apparent Power Registers			
1343	PowerReacSum	PowerIntScale	Total reactive power VAR
1344	PowerReac1	PowerIntScale	Reactive power VAR, meter element 1
1345	PowerReac2	PowerIntScale	Reactive power VAR, meter element 2
1346	PowerReac3	PowerIntScale	Reactive power VAR, meter element 3
1347	PowerAppSum	PowerIntScale	Total apparent power VA
1348	PowerApp1	PowerIntScale	Apparent power VA, meter element 1
1349	PowerApp2	PowerIntScale	Apparent power VA, meter element 2
1350	PowerApp3	PowerIntScale	Apparent power VA, meter element 3

Registers	Name	Units	Description
Voltage Registers			
1213	VoltAvgLN	0.1 V	Average line-to-neutral voltage
1214	VoltAN	0.1 V	RMS voltage, phase A to neutral
1215	VoltBN	0.1 V	RMS voltage, phase B to neutral
1216	VoltCN	0.1 V	RMS voltage, phase C to neutral
1217	VoltAvgLL	0.1 V	Average line-to-line voltage
1218	VoltAB	0.1 V	RMS voltage, line-to-line, phase A to B
1219	VoltBC	0.1 V	RMS voltage, line-to-line, phase B to C
1220	VoltCA	0.1 V	RMS voltage, line-to-line, phase C to A
Current Registers			
1351	Current1	CurrentIntScale	RMS current, CT1
1352	Current2	CurrentIntScale	RMS current, CT2
1353	Current3	CurrentIntScale	RMS current, CT3
Frequency Register			
1221	Freq	0.1 Hz	Power line frequency
Power Factor Registers			
1339	PowerFactorAvg	0.01	Power factor, average
1340	PowerFactor1	0.01	Power factor, meter element 1
1341	PowerFactor2	0.01	Power factor, meter element 2
1342	PowerFactor3	0.01	Power factor, meter element 3
Demand Registers			
1354	DemandSum	PowerIntScale	Active power sum demand averaged over the demand period
1355	DemandSumMin*	PowerIntScale	Minimum power sum demand
1356	DemandSumMax*	PowerIntScale	Maximum power sum demand
1357	DemandAppSum	PowerIntScale	Apparent power sum demand
1358	Demand1	PowerIntScale	Active power demand, meter element 1
1359	Demand2	PowerIntScale	Active power demand, meter element 2
1360	Demand3	PowerIntScale	Active power demand, meter element 3

*These registers are preserved across power failures.

†These registers support presetting the value or resetting it to zero.

4.2.7 Configuration Register List

These registers configure and customize the WattNode meter. For simple installations, only **CtAmps** needs to be set. By default, there is no passcode for the configuration, but if security is required, a passcode can be assigned. The configuration registers are all integer format except **NominalCtVolts1**, **NominalCtVolts2**, and **NominalCtVolts3**, which are 32-bit floating point. See the section [4.4 Configuration](#) below for detailed information.

Registers	Name	Units	Default	Description
1601, 1602	<u>ConfigPasscode</u>		0	Optional passcode to prevent unauthorized changes to configuration
1603	<u>CtAmps</u>	1 A	5	Assign global current transformer rated current
1604	<u>CtAmps1</u> *	1 A	5	CT1 rated current (0 to 30000)
1605	<u>CtAmps2</u> *	1 A	5	CT2 rated current (0 to 30000)
1606	<u>CtAmps3</u> *	1 A	5	CT3 rated current (0 to 30000)
1607	<u>CtDirections</u> *		0	Optionally invert CT orientations (0 to 7)
1608	<u>Averaging</u> *		1	Configure measurement averaging
1609	<u>PowerIntScale</u> *	1 W	0 (auto)	Integer power register scaling (0 to 10000)
1610	<u>DemPerMins</u> *	1 minute	15	Demand period (1 to 720)

Registers	Name	Units	Default	Description
1611	<u>DemSubints</u> *		1	Number of demand subintervals (1 to 10)
1612	<u>GainAdjust1</u> *	1/10000th	10000	CT1 gain adjustment (5000 to 20000)
1613	<u>GainAdjust2</u> *	1/10000th	10000	CT2 gain adjustment (5000 to 20000)
1614	<u>GainAdjust3</u> *	1/10000th	10000	CT3 gain adjustment (5000 to 20000)
1615	<u>PhaseAdjust1</u> *	0.001 deg	-1000	CT1 phase angle adjust (-8000 to 8000)
1616	<u>PhaseAdjust2</u> *	0.001 deg	-1000	CT2 phase angle adjust (-8000 to 8000)
1617	<u>PhaseAdjust3</u> *	0.001 deg	-1000	CT3 phase angle adjust (-8000 to 8000)
1618	<u>CreepLimit</u> *	ppm	400	Minimum current and power for readings
1619	<u>PhaseOffset</u> *		120	Not used. Included for WNC compatibility.
1620	<u>ZeroEnergy</u>		0	Write 1 to zero all resettable energy registers
1621	<u>ZeroDemand</u>		0	Write 1 to zero all demand values
1622	<u>CurrentIntScale</u> *		20000	Scale factor for integer currents (0 to 32767)
1623	<i>reserved</i>			
1624	<u>MeterConfig1</u> *		10	Configure voltage for meter element 1
1625	<u>MeterConfig2</u> *		20	Configure voltage for meter element 2
1626	<u>MeterConfig3</u> *		30	Configure voltage for meter element 3
1627	<i>reserved</i>			
1628	<u>ChangeCounter</u> *		1	Count of configuration changes
1629, 1630	<u>NominalCtVolts1</u> *	Vac	0.33333	CT1, Voltage of full scale CT signal
1631, 1632	<u>NominalCtVolts2</u> *	Vac	0.33333	CT2, Voltage of full scale CT signal
1633, 1634	<u>NominalCtVolts3</u> *	Vac	0.33333	CT3, Voltage of full scale CT signal
1635	<i>reserved</i>			
1636	<u>ConnectionType</u> *		1	Shortcut to set all three MeterConfig registers
1637	<u>VoltsNoiseFloor</u> *	0.1%	200 (20%)	Minimum voltage as a percentage.
1638	<u>CtMonitoring</u>		0	Configure disconnected CT detection (0 to 2)
1639, 1640	<u>PtRatio</u>		1.0	Potential transformer ratio (0.05 to 300.0)
1685	<u>OptSignedCurrent</u> *		0	Report signed current. 0=current always positive, 1=current sign matches the sign of the active power.
1686	<u>OptEnergySumMethod</u> *		0	Option to specify how meter elements are summed.

*These registers are preserved across power failures.

4.2.8 Communication Register List

These integer registers can be used to program the Modbus slave address, the baud rate, and other advanced communication settings, like even parity. See [4.5 Communication Configuration](#) below for details.

Registers	Name	Default	Description
1651	<u>ApplyComConfig</u>	0	Writing 1234 applies the configuration settings below. Reads 1 if pending changes not applied yet.
1652	<u>Address</u> *	varies	Modbus address
1653	<u>BaudRate</u> *	varies	1 = 1200 baud, 2 = 2400 baud, 3 = 4800 baud, 4 = 9600 baud, 5 = 19200 baud, 6 = 38400 baud, 7 = 57600 baud, 8 = 76800 baud, 9 = 115200 baud
1654	<u>ParityMode</u> *	0	0 = 8N1 (no parity, one stop bit) 1 = 8E1 (even parity, one stop bit) 2 = 8N2 (no parity, two stop bits)
1655	<u>ModbusMode</u> *	0	0 = RTU
1656	<u>ReplyDelay</u> *	5	Minimum Modbus reply delay: 0 to 20 ms
1657, 1658	<u>SerialNumberKey</u>		Serial number of meter to change Modbus address
1659	<u>NewAddress</u>		New Modbus address for meter with SerialNumberKey

*These registers are preserved across power failures.

4.2.9 Diagnostic Register List

These registers provide information and diagnostics for the meter. These are all integer registers. **UptimeSecs** and **TotalSecs** are 32-bit integer dual registers: the first register provides the lower 16 bits, and the second register provides the upper 16 bits of the 32-bit value. See [4.6 Diagnostics](#) and [4.9 Errors](#) below for detailed information.

Registers	Name	Units	Description
0001, 0002	<u>Dummy</u> ¹		Dummy register; always returns zero; can be used to scan for active Modbus devices
1701, 1702	<u>SerialNumber</u> ^{1*}		The WattNode meter serial number
1703, 1704	<u>UptimeSecs</u> ¹	Seconds	Time in seconds since last power on
1705, 1706	<u>TotalSecs</u> ^{1*}	Seconds	Total seconds of operation
1707	<u>Model</u> ^{1*}		Encoded WattNode model
1708	<u>Version</u> ^{1*}		Firmware version
1710	<u>ErrorStatusQueue</u> [*]	n.a.	List of recent errors and events
1711	<u>PowerFailCount</u> ^{1*}		Power failure count
1712	<u>CrcErrorCount</u>		Count of Modbus CRC communication errors
1713	<u>FrameErrorCount</u>		Count of Modbus framing errors
1714	<u>PacketErrorCount</u>		Count of bad Modbus packets
1715	<u>OverrunCount</u>		Count of Modbus buffer overruns
1716	<u>ErrorStatus1</u>	n.a.	Newest error or event (0 = no errors)
1717	<u>ErrorStatus2</u>	n.a.	Next oldest error or event
1718	<u>ErrorStatus3</u>	n.a.	Next oldest error or event
1719	<u>ErrorStatus4</u>	n.a.	Next oldest error or event
1720	<u>ErrorStatus5</u>	n.a.	Next oldest error or event
1721	<u>ErrorStatus6</u>	n.a.	Next oldest error or event
1722	<u>ErrorStatus7</u>	n.a.	Next oldest error or event
1723	<u>ErrorStatus8</u>	n.a.	Oldest error or event
1760	<u>CtStatus1</u>		Status of CT1 disconnect detection: 0 = Normal or no monitoring 1 = CT disconnected 2 = CT reconnected (was disconnected)
1761	<u>CtStatus2</u>		Status of CT2 disconnect detection
1762	<u>CtStatus3</u>		Status of CT3 disconnect detection

¹These registers are read-only.

*These registers are preserved across power failures.

4.2.10 Option Information Registers

These registers document options ordered with the meter. They are read-only, but values associated with an option information register may be overridden in the field (such as the **CtAmps1**) unless the configuration is locked (**Option L**). These registers always show the original option value. If an option has not been specified, the value will be zero.

For details, see [4.7 Option Information](#) and <https://ctlsys.com/s/modbus-option-id/>.

Registers	Name	Override Register	Description
1709	Options	n.a.	Meter options as a bit field
1724	OptCtAmps1	CtAmps1	Option CT - CT1 CtAmps
1725	OptCtAmps2	CtAmps2	Option CT - CT2 CtAmps
1726	OptCtAmps3	CtAmps3	Option CT - CT3 CtAmps
1727	OptModbusMode	none	<i>Not supported on the WND-series WattNode</i>
1728	OptAddress	Address	Option AD - Factory assigned Modbus address

Registers	Name	Override Register	Description
1729	OptBaudRate	BaudRate	Factory assigned baud rate
1730	OptParityMode	ParityMode	Option EP - Factory assigned even parity
1737	OptLockedConfig	none	Option L - Factory locked configuration settings
1738	OptFastPower	none	<i>Not supported on the WND-series WattNode</i>
1739	OptRs485-Termination	none	DIP switch 7 controls RS-485 termination. This is standard on the WND-WR-MB.
1740	OptOemFeatures	none	Factory option for OEM features
1741	OptNrEnergies	none	Factory option for all energies non-resettable

Note: Some option registers from the WNC series of meters are not supported by the WND-series WattNode meters. It is still possible to read those registers and they will return a value of 0, indicating the option is not present.

4.2.11 Custom Register Map

The WattNode meter offers the ability to remap the register addresses to allow the following:

- Combine separate registers into a contiguous range, which can be read with a single Modbus read command. This is more efficient than reading two or more discontinuous sets of registers, especially if you are monitoring many meters on a single Modbus subnet.
- Emulate another device by reorganizing the registers.
- Swap the most and least significant words of 32-bit registers (used for floating-point and integer energy values) for compatibility with Modbus master software that expects a different register order.

For details, see <https://ctlsys.com/s/modbus-register-map/>.

4.3 Measurement Registers

4.3.1 Energy

All active, reactive, and apparent energy register values are preserved through power failures. When the meter is not powered, the energy consumed is not measured. To preserve the energy measurement across power outages, the meter writes all the energy values to non-volatile (ferroelectric RAM) memory every second. When power returns, the last stored values are recovered.

In the WattNode meter, most energy registers can be reset to zero by writing “1” to the **ZeroEnergy** register. They can also be set to zero or a preset value by writing the desired value directly to each register. All energy registers ending with “NR” (for non-resetting) cannot be reset to zero and do not allow writes for billing security. You can protect all energy registers from being zeroed or preset by setting a **ConfigPasscode**. If you do zero or preset an energy register, it may take up to one second for the change to take effect.

All energy registers wrap around to zero when they reach 100 gigawatt-hours (100 x 10⁹ watt-hours) or negative 100 gigawatt-hours (only some energy registers allow negative values).

Internally, the energies are computed approximately every 100 milliseconds. Then, once per second, the energy registers are updated with the latest value.

4.3.2 Active Energy

Commonly known as kWh (kilowatt-hours), the active (real) energy is the integral of active power over time. Many installations only use the active energy measurement. It is commonly used for billing or sub-metering. Because energy is an accumulated value, it can be used on networks that are accessed infrequently (like a utility meter that only needs to be read once a month).

Energy1, Energy2, Energy3

The individual meter element energy registers report the net active energy for each meter element, where “net” means negative energy is subtracted from the total, possibly resulting in negative energy values. These registers are appropriate for net metering applications (i.e. photovoltaic) where you wish to measure the net energy in situations where you may sometimes consume energy and other times generate energy.

EnergySum, EnergySumNR

EnergySum is the net active energy sum of all active meter elements, where “net” means negative energy subtracts from the total. Ignoring overflow, ***EnergySum = Energy1 + Energy2 + Energy3***. The energy sum value is appropriate for net metering applications (i.e. photovoltaic) where you wish to measure the net energy in situations where you may sometimes consume energy and other times generate energy. Use ***EnergyPosSum*** instead if you do not want negative energy to subtract from the total.

The ***EnergySumNR*** is identical to ***EnergySum*** except that it cannot be reset to zero.

EnergyPos1, EnergyPos2, EnergyPos3

These are the individual meter element positive active energy registers. Every 100 milliseconds, the energy for the last 100 ms is computed for each meter element, if it is positive, then it is added to the corresponding internal positive energy accumulator. Once a second, the values from the internal positive energy accumulators update the registers.

EnergyPosSum, EnergyPosSumNR

EnergyPosSum and ***EnergyPosSumNR*** are equivalent to traditional utility meters that register positive energy. This is appropriate for applications where you do not expect negative energy, do not wish to measure negative energy, or wish to separately accumulate the positive energy.

The ***EnergyPosSumNR*** is identical to ***EnergyPosSum*** except that it cannot be reset to zero.

The positive energy sum values can be accumulated two different ways. See **[OptEnergySumMethod](#)** for information.

4.3.3 Negative Energy

The negative energy registers are exactly like the positive energy registers except they accumulate negative energy. The reported energy values are positive. In other words, if the WattNode measures 1000 kWh of negative energy, ***EnergyNegSum*** reports 1000 (not -1000). These are useful when you need to separately track consumed and produced energy.

EnergyNeg1, EnergyNeg2, EnergyNeg3

These are the individual meter element negative active energy registers. Every 100 milliseconds, the energy for the last 100 ms is computed for each meter element, if it is negative, then the absolute value is added to the corresponding internal negative energy accumulator. Once a second, the values from the internal negative energy accumulators update the registers.

EnergyNegSum, EnergyNegSumNR

The ***EnergyNegSumNR*** is identical to ***EnergyNegSum*** except that it cannot be reset to zero or preset by writing a value.

The negative energy sum values can be accumulated two different ways. See **[OptEnergySumMethod](#)** for information.

4.3.4 Power

The power registers measure active (real) power for each meter element and for the sum of all meter elements. The measured power is generally positive, but may also be negative, either

because you are generating power (such as with solar panels), or because the meter is not connected properly.

The power registers (except the **PowerFast** registers) include configurable averaging from 100 milliseconds to 60 seconds. The default averaging is 5 seconds. See [Averaging \(1608\)](#) below for more information.

The floating-point power registers are in units of watts.

The integer power registers are scaled by **PowerIntScale** to prevent overflow. The integer power registers cannot exceed ± 32767 ; anything larger is limited to ± 32767 . To allow for larger power values, **PowerIntScale** acts as a multiplier by 1, 10, 100, 1000, or 10000. See [4.4 Configuration](#) for details. To scale the integer **Power1**, **Power2**, **Power3**, or **PowerSum** to watts, use the following equation (where *PowerXXX* is the integer **Power1**, **Power2**, **Power3**, or **PowerSum**):

$$\text{ScaledPower}(W) = \text{PowerXXX} \cdot \text{PowerIntScale}$$

For example, if **PowerIntScale** (1609) is 100, and the integer **PowerSum** (1209) reports 2500, then the power sum is $2500 \cdot 100 = 250,000 \text{ W}$ (or 250 kW).

Power1, Power2, Power3

These registers report the active power for each meter element, one for each CT input (**CT1**, **CT2**, and **CT3**).

PowerSum

This is the sum of the active power for active meter elements (see [2.3.1 Variables and Terminology](#)). This includes negative values, so if one element is negative, it reduces the reported **PowerSum**.

PowerFast1, PowerFast2, PowerFast3, PowerFastSum, SecondsFast

The **PowerFast** registers update every 100 milliseconds with no averaging. They are intended for applications like export limiting (zero export), where it is necessary to report power changes as fast as possible. They are only available as floating point registers.

The **SecondsFast** register updates at the same time as the **PowerFast** registers and reports the number of seconds as a floating point number. It counts up to 86,400 (the number of seconds in a day) at which point it resets back to zero and starts counting up again. **SecondsFast** can be used to detect when the power fast readings have updated by checking that the value has changed (say from 410.0 to 410.1). Because the WattNode does not know the time of day, **SecondsFast** is not synchronized to the time of day.

4.3.5 Reactive Energy

The WattNode meter measures the reactive energy including the fundamental and harmonics. Reactive energy is also known as kVAR-hours. Inductive loads, like motors, generate positive reactive power and energy, while capacitive loads generate negative reactive energy.

EnergyReacSum, EnergyReac1, EnergyReac2, EnergyReac3

These are all bidirectional (net) reactive energy registers that can count up or down depending on the sign of the reactive power.

EnergyReacPosSum, EnergyReacPos1, EnergyReacPos2, EnergyReacPos3

The positive reactive energy registers only accumulate positive reactive energy (inductive).

The positive reactive energy sum values can be accumulated two different ways. See [OptEnergySumMethod](#) for information.

EnergyReacNegSum, EnergyReacNeg1, EnergyReacNeg2, EnergyReacNeg3

The negative reactive energy registers only accumulate negative reactive energy (capacitive).

The negative reactive energy sum values can be accumulated two different ways. See [***OptEnergySumMethod***](#) for information.

4.3.6 Apparent Energy

EnergyAppSum, EnergyApp1, EnergyApp2, EnergyApp3

Apparent energy (kVA-hours) is the accumulation of apparent power over time. The apparent power is the RMS voltage multiplied by the RMS current for each meter element. For example, if you have 120 Vac RMS, 10 amps RMS, and one active meter element, the apparent power will be 1200 VA. At the end of an hour, the apparent energy will be 1.2 kVA-hours. Apparent energy is always positive.

The WattNode meter's apparent energy measurement includes harmonics.

4.3.7 Reactive Power

Reactive power is also known as VARs. Inductive loads, like motors, generate positive reactive power, while capacitive loads generate negative reactive power. Reactive power transfers no net energy to the load and generally is not metered by the utility. Loads with high reactive power relative to the active power tend to have lower power factors. The integer reactive power registers are scaled by [***PowerIntScale***](#).

The WattNode meter reactive power includes the fundamental and harmonics.

To scale the integer values to VARs, use the following equation, where *PowerReacXXX* is one of [***PowerReac1, PowerReac2, PowerReac3, or PowerReacSum***](#)):

$$\text{ScaledPowerReac(VAR)} = \text{PowerReacXXX} \cdot \text{PowerIntScale}$$

For example, if [***PowerIntScale***](#) (1609) is 100, and the integer [***PowerReacSum***](#) (1343) reports 1500, then the scaled reactive power sum is $1500 * 100 = 150,000$ VAR (or 150 kVAR).

PowerReac1, PowerReac2, PowerReac3

These registers report the reactive power for each meter element, one for each CT input (**CT1**, **CT2**, and **CT3**).

PowerReacSum

The [***PowerReacSum***](#) is the sum of the reactive power of active meter elements. This can include negative values, so if one meter element is negative, it reduces the reported [***PowerReacSum***](#).

4.3.8 Apparent Power

Apparent power (VA) can be described three ways:

- 3) The RMS voltage multiplied by the RMS current.
- 4) The square root of the active power squared plus the reactive power squared.
- 5) The absolute value or magnitude of the complex power.

The WattNode uses technique #1 to compute the apparent power. The apparent power measurement includes the fundamental and harmonics.

Apparent power is always a positive quantity. The integer apparent power registers are scaled by [***PowerIntScale***](#). See [**4.3.4 Power**](#) above for more details and sample calculations.

PowerApp1, PowerApp2, PowerApp3

These are the individual meter element apparent power measurements.

PowerAppSum

The [***PowerAppSum***](#) is the sum of apparent power for active meter elements.

4.3.9 Voltage

Voltage measurements are available as floating-point and integer registers. All integer voltage registers are reported in units of 0.1 Vac, so 1234 = 123.4 Vac.

Any meter voltage channel (V_{AN} , V_{BN} , V_{CN} , V_{AB} , V_{BC} , or V_{CA}) with a measured voltage less than 20% of the nominal line voltage or the highest measured line voltage (whichever is higher), is considered inactive. Inactive voltage channels report a voltage of zero and are not included in average voltage measurements. Also, the power and energy for inactive channels is forced to zero. See [***VoltsNoiseFloor***](#) below for more details.

The voltage registers include configurable averaging from 100 milliseconds to 60 seconds. The default averaging is 5 seconds. See [***Averaging***](#) below for more information.

VoltAvgLN

This is the average line-to-neutral voltage (average of ***VoltAN***, ***VoltBN***, and ***VoltCN***). Only active voltage channels are included.

VoltAN, VoltBN, VoltCN

These are the RMS AC voltages for each voltage channel, measured relative to the neutral connection on the meter. If neutral is not connected, then they are measured relative to the ground connection, but with reduced accuracy.

Voltage inputs that are not connected may report random voltages.

VoltAvgLL

This is the average line-to-line voltage (average of ***VoltAB***, ***VoltBC***, and ***VoltCA***). Only active voltage channels are included.

VoltAB, VoltBC, VoltCA

These are the RMS AC line-to-line voltages. Voltage inputs that are not connected may report random voltages.

4.3.10 Current

The WattNode meter measures the RMS current for each CT input.

Current1, Current2, Current3

These are the measured current, in amps, for ***CT1***, ***CT2***, and ***CT3***.

The floating-point current registers are reported in units of amps.

The integer current registers can only report values from -32767 to +32767; anything larger is limited to ± 32767 . The integer current registers are in scaled amps. The following equation converts the scaled register value to actual amps, where ***CurrentX*** is ***Current1***, ***Current2***, or ***Current3***; and ***CtAmpsX*** is ***CtAmps1***, ***CtAmps2***, or ***CtAmps3***.

$$\text{ScaledCurrent(Amps)} = \text{CurrentX} \cdot \text{CtAmpsX} / \text{CurrentIntScale}$$

The configuration register ***CurrentIntScale***, with a default value of 20000, controls the scaling. The scaling is set up so that the integer current registers reports the full ***CurrentIntScale*** value, when the measured current equals the rated amps of the CT.

For example, with 200 amp current transformers ($\text{CtAmpsX} = 200$) and ***CurrentIntScale*** = 20000, if ***Current1*** (1351) reports 5000, the actual current is $5000 \cdot 200 / 20000 = 50.00$ amps.

The WattNode can optionally set the sign of the current to match the sign of the active power. For example, if ***Power1*** is negative, then ***Current1*** would also report a negative value. This is not enabled by default but can be enabled by writing '1' to the register ***OptSignedCurrent*** (1685). The WNC series of meters always made the sign of the current match the sign of the active power.

4.3.11 Frequency

Freq

The WattNode meter measures the AC line frequency in Hertz. The frequency is available in both floating-point and integer registers. The integer **Freq** register reports the frequency in units of 0.1 Hz. The WattNode selects the voltage channel with the largest RMS voltage as the channel for measuring the line frequency. It assumes all voltage channels have the same line frequency.

4.3.12 Power Factor

The power factor is the ratio of the active power to the apparent power. Resistive loads, like incandescent lighting and electric heaters, should have a power factor near 1.0. Power-factor corrected loads, like computers, should be near 1.0. Motors can have power factors from 0.2 to 0.9, but are commonly in the 0.5 to 0.7 range.

If the power for a meter element is negative, the power factor will also be negative. The reported power factor will be 1.0 for any meter elements measuring zero power and for inactive meter elements (see [2.3.1 Variables and Terminology](#)).

The WattNode meter measures the apparent power factor, which includes harmonics.

The power factor values are available as both floating-point and integer registers. The integer power factor registers are reported in units of 0.01, so 85 equals a power factor of 0.85.

PowerFactor1, PowerFactor2, PowerFactor3

These are the power factor values for each meter element.

PowerFactorAvg

This is the average power factor, computed as $\text{PowerSum} / \text{PowerAppSum}$. Inactive meter elements are not included in the average.

4.3.13 Demand

Demand is defined as the average power over a specified time interval. Typical demand intervals are 5, 10, 15 (default), 30, 60, etc. up to 720 minutes, but the WattNode meter supports arbitrary demand intervals from 1 to 720 minutes (12 hours). The meter records the peak demand for metering applications where the measurements may only be accessed weekly or monthly.

Since the WattNode meter can measure bidirectional power (positive and negative), and the demand is the average power over an interval, demand can also be positive or negative. This is only likely to occur with something like a grid-tied PV system, where you may put energy back into the grid at certain times of the day (negative power). In this case, you would see negative demand. If you have both positive and negative power during a demand interval, both the positive and the negative data will be averaged together, such that the negative power subtracts from the positive, reducing the overall demand.

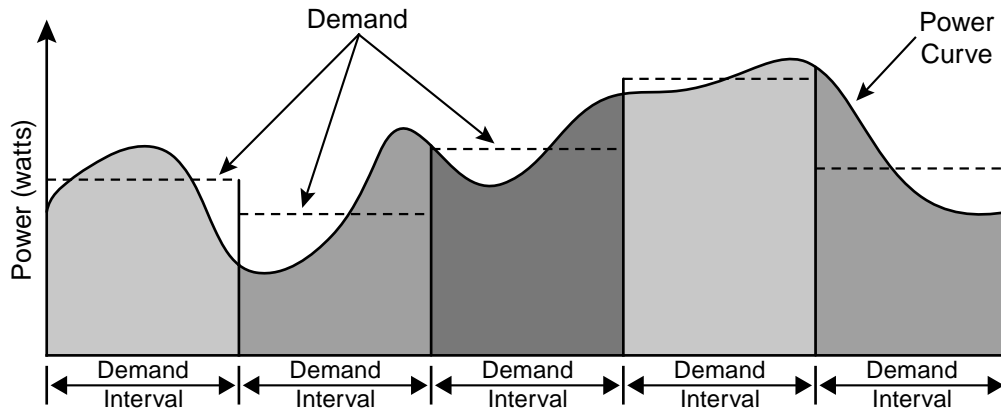

Figure 14: Demand Measurement

WattNode meters also supports rolling demand (also called “sliding window”), in which the demand intervals are evenly divided into a fixed number of subintervals. At the end of each subinterval, the average power over the demand interval is computed and output. This results in better accuracy, especially for demand peaks which would not have lined up with the demand interval without subintervals. On power up, the demand measurements will report zero until one full demand interval is completed. From 1 to 10 subintervals are supported. A subinterval count of one (or zero) results in the standard demand measurement without rolling demand. See [4.4 Configuration](#) for information on configuring the demand.

Any changes to the demand configuration ([DemPerMins](#), [DemSubints](#)), CT configuration ([CtAmps](#), [CtAmps1](#), [CtAmps2](#), [CtAmps3](#), [CtDirections](#)) or potential transformer ratio ([PtRatio](#)) will zero the reported demand and start a new demand measurement. The [DemandSumMin](#) and [DemandSumMax](#) will not be reset by configuration changes.

To manually zero some or all of the demand registers, see the [ZeroDemand](#) register in [4.4 Configuration](#) below.

The floating-point demand registers are reported in units of watts, while the integer demand registers must be scaled by [PowerIntScale](#) to compute watts. To scale the integer [DemandSum](#), [Demand1](#), [Demand2](#), [Demand3](#), [DemandSumMin](#), [DemandSumMax](#), or [DemandAppSum](#), use the following equation:

$$\text{ScaledDemand}(W) = \text{Demand} \cdot \text{PowerIntScale}$$

For example, if [PowerIntScale](#) (1609) is 100, and the integer [DemandSum](#) (1354) reports 4700, then the demand is $4700 * 100 = 470,000$ watts (or 470 kW).

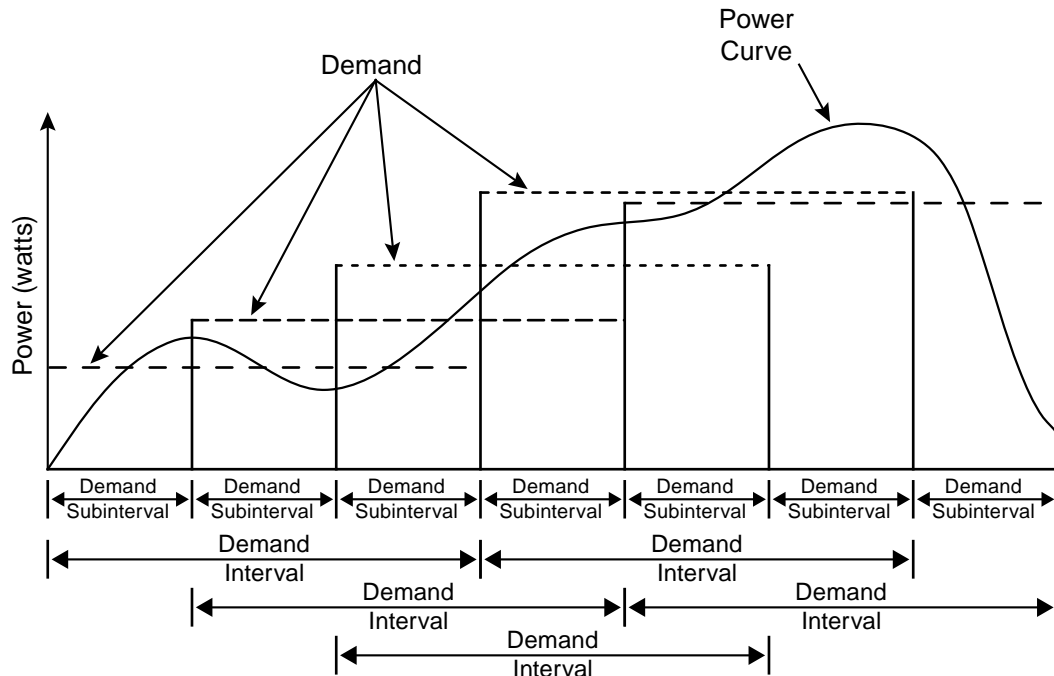

Figure 15: Rolling Demand with Three Subintervals

DemandSum

The **DemandSum** register is updated at the end of every subinterval with the average **PowerSum** over a full demand interval. After a power cycle or configuration change, **DemandSum** will report zero until the completion of one full demand interval.

Demand1, Demand2, Demand3

The active power demand is computed for each meter element from **Power1**, **Power2**, and **Power3**.

DemandSumMin

The **DemandSumMin** is the smallest measured **DemandSum** (this may be negative for systems with power generation). It is preserved across power failures and can be reset with the **ZeroDemand** register. Note: there are no minimum or maximum demand registers for **Demand1**, **Demand2**, and **Demand3**.

DemandSumMax

The **DemandSumMax** is the largest (more positive) measured **DemandSum**. It is preserved across power failures and can be reset with the **ZeroDemand** register.

DemandAppSum

DemandAppSum is computed the same way as **DemandSum**, but using the apparent power sum (**PowerAppSum**).

4.4 Configuration

ConfigPasscode (1601, 1602)

The WattNode meter has an optional configuration passcode to prevent unauthorized changes to the configuration. As shipped from the factory, the **ConfigPasscode** is set to "0", disabling the passcode. If a passcode is set, the meter must be unlocked by writing the correct value to

ConfigPasscode before any configuration registers can be changed and before the energy or demand registers can be reset to zero.

You can read the **ConfigPasscode** register to determine if the meter is locked. You cannot read the actual passcode itself. If you lose your passcode, contact support for assistance.

- **0** - Unlocked
- **1** - Locked

Invalid unlock attempts will result in the Modbus exception 03 - "Illegal data value", and prevent more attempts for five seconds. An unlocked meter will become locked again after five minutes or when "1" is written twice to **ConfigPasscode**.

The passcode can be set (or changed) by writing the new passcode to **ConfigPasscode** twice within 30 seconds. If a passcode is already set, the meter must be unlocked first. Setting a passcode does not immediately lock the meter: you must wait five minutes or write "1" twice to **ConfigPasscode**.

Valid passcode values are:

- 0 - this disables the passcode.
- 2 to 2,147,483,647 - use at least six digits for a secure passcode.

The passcode is a 32-bit value, so both register locations **1601** and **1602** must be written when unlocking the WattNode or setting a passcode.

CtAmps (1603)

Writing the **CtAmps** register is a shortcut to quickly set **CtAmps1**, **CtAmps2**, and **CtAmps3** to the same value. If you read **CtAmps** and **CtAmps1**, **CtAmps2**, **CtAmps3** are all identical, then **CtAmps** will return the common value; otherwise it will return 0 (zero) to indicate there is no common value.

CtAmps1, CtAmps2, CtAmps3 (1604 , 1605, 1606)

The CT amps registers set the rated current of the attached current transformers (CTs) in amps (integer). This allows the use of different CTs on different CT inputs: **CT1**, **CT2**, and **CT3**. Rated current is the amperage that results in a full-scale or 100% reading. For most CTs, this will result in a 0.33333 Vac RMS output from the CT, but some CTs have a milliamp output or different full-scale output voltage (see **NominalCtVolts**).

You can order the meter from the factory with the CtAmps preconfigured using **Option CT=xxx** or **Option CT=xxx/yyy/zzz** if there are different CTs on **CT1**, **CT2**, and **CT3**. For example, **Option CT=100/100/50** sets **CtAmps1** = 100, **CtAmps2** = 100, and **CtAmps3** = 50.

The specified rated CT amps for each CT input (**CtAmps1**, **CtAmps2**, and **CtAmps3**), affect the scaling for the integer current registers **Current1**, **Current2**, and **Current3**. See section [4.3.10 Current](#) above for details.

The CtAmps registers may be set to any value from 0 to 30,000 amps. Setting a value of zero will deactivate that CT, causing current and power for that element to report zero. The energy registers for the meter element will stay at whatever value they had when the CT was deactivated. If voltage is present, the LED will light solid green, otherwise, it will be off. The power factor will report 1.0.

CtDirections (1607)

On occasion, current transformers are installed with the label "This side towards source" facing the load instead of the source, or with the white and black wires swapped at the meter. If the electrical installer notices this, they can fix it, but sometimes the problem is not noticed until the electrician is gone and some or all of the reported power values are unexpectedly negative.

You can correct this with the **CtDirections** register:

- **0** - All CTs normal
- **1** - Reverse polarity for CT1
- **2** - Reverse polarity for CT2
- **4** - Reverse polarity for CT3
- **3** - Reverse polarity for CT1 and CT2
- **5** - Reverse polarity for CT1 and CT3
- **6** - Reverse polarity for CT2 and CT3
- **7** - Reverse polarity for CT1, CT2, and CT3

Reversing the CT polarity with **CtDirections** will also reverse the meter element LED indications. So if a meter element status LED is flashing red and you reverse the CT with **CtDirections**, the LED will change to green flashing. This cannot fix situations where CTs are not matched to the voltage phases, such as swapping CT1 and CT2 on the current transformer inputs. To correct CT to voltage input mismatches, see the **MeterConfig** registers.

Averaging (1608)

The WattNode includes averaging for these registers: **PowerSum**, **Power1**, **Power2**, **Power3**, **VoltAvgLN**, **VoltAN**, **VoltBN**, **VoltCN**, **VoltAvgLL**, **VoltAB**, **VoltBC**, **VoltCA**, **Freq**, **PowerFactorAvg**, **PowerFactor1**, **PowerFactor2**, **PowerFactor3**, **PowerReacSum**, **PowerReac1**, **PowerReac2**, **PowerReac3**, **PowerAppSum**, **PowerApp1**, **PowerApp2**, **PowerApp3**, **Current1**, **Current2**, and **Current3**.

Averaging is beneficial because it reduces measurement noise, and if the WattNode is being polled less often than once a second (say once a minute), then the average over the last minute provides a more accurate reading than just the data from the last second, which might be randomly high or low. Averaging is configured by setting the **Averaging** register to one of the following values:

Table 8: Averaging Settings

Averaging Register	Averaging Period	Update Rate
100	100 milliseconds	Every 100 milliseconds
200	200 milliseconds	Every 100 milliseconds
500	500 milliseconds	Every 100 milliseconds
0	1 second	Every 200 milliseconds
1 (default)	5 seconds	Every 1 second
2	20 seconds	Every 4 seconds
3	60 seconds	Every 12 seconds

Also, any multiple of 100 from 100 to 60,000 is allowed to specify a custom averaging in milliseconds from 100 to 60,000 milliseconds (0.1 to 60 seconds). In general, the update rate will be one-fifth of the averaging period.

PowerIntScale (1609)

Note: this is only useful if you are using the integer power registers.

In order to report power as an integer value in the range from -32,767 to 32,767, the meter must scale the power so that it does not overflow. By default, the WattNode meter selects a **PowerIntScale** value of 1, 10, 100, 1000, or 10000 whenever the **CtAmps** (or **CtAmps1**, **CtAmps2**, or **CtAmps3**) or **PtRatio** are changed. The meter tries to select a value that will not overflow unless the power exceeds 120% of full-scale at the nominal voltage scaled by **PtRatio** (this is not always possible when both **CtAmps** and **PtRatio** are large).

Table 9: PowerIntScale Settings

PowerIntScale	Power Resolution	Maximum Power Reading
0 (default)	Auto-configure	varies
1	1 watt	±32767 W
10	10 watt	±327.67 kW
100	100 watts	±3276.7 kW
1000	1000 watts (1 kW)	±32767 kW (32.8 MW)
10000	10000 watts (10 kW)	±327670 kW (328 MW)
Custom Values	PowerIntScale • 1 W	±(PowerIntScale • 32767 W)

You may also choose your own custom value for **PowerIntScale** including values that are not multiples of 10.

If **PowerIntScale** is set to auto-configure (0), then reading **PowerIntScale** will show the actual scale factor instead of 0.

To compute the actual power from integer power registers, use the following equation (note, there is no scaling for the floating-point power registers, which always report power in watts):

$$\text{ActualPower}(W) = \text{PowerRegister} \cdot \text{PowerIntScale}$$

PowerIntScale is used with the following registers: **PowerSum**, **Power1**, **Power2**, **Power3**, **PowerReacSum**, **PowerReac1**, **PowerReac2**, **PowerReac3**, **PowerAppSum**, **PowerApp1**, **PowerApp2**, **PowerApp3**, **Demand**, **DemandMin**, **DemandMax**, **DemandApp**.

CurrentIntScale (1622)

Note: this is only useful if you are using integer current registers.

When reporting current values as integers, the WattNode meter scales the current values so that a current equal to the CT rated amps will result in an output value of **CurrentIntScale**. The default **CurrentIntScale** is 20000, and **CurrentIntScale** may be set to any value from 0 to 32767. Setting the **CurrentIntScale** to 0 will restore the default value of 20000. See **Current1**, **Current2**, **Current3** for more details.

GainAdjust1, GainAdjust2, GainAdjust3 (1612, 1613, 1614)

You may need to adjust the WattNode meter to match the results from a reference meter (such as the utility meter) or to correct for known current transformer errors. The **GainAdjust** registers adjust the gains of **CT1**, **CT2**, and **CT3**, which in turn affect the power, energy, and current readings for each meter element.

The equation for the gain adjustment follows, where *GainAdjustX* is **GainAdjust1**, **GainAdjust2**, or **GainAdjust3**.

$$\text{CtGain} = \text{GainAdjustX} / 10000$$

The default values for the **GainAdjust** registers are 10,000, resulting in no adjustment. Setting the value to 10,200 increases all the power, energy, and current readings from the meter by 2% (10,200 / 10,000 = 102%). Setting the value to 9,800 decreases the readings by 2% (9,800 / 10,000 = 98%). The allowed range is from 5,000 to 20,000 (50% to 200%).

PhaseAdjust1, PhaseAdjust2, PhaseAdjust3 (1615, 1616, 1617)

For maximum accuracy, there may be cases where you wish to compensate for the phase angle error of the current transformers you are using. The **PhaseAdjust** registers allow the phase angle to be adjusted on each CT by up to ±8 degrees in increments of one millidegree. For example, if your CT causes a phase lead of 0.6 degrees (or 36 minutes), you could correct for this by setting **PhaseAdjust1**, **2**, and **3** to -600, which subtracts 600 millidegree or 0.6 degree from the phase

lead. Use negative values to compensate for a phase lead in the CT (most common). The default adjustment is 0.

NominalCtVolts1, NominalCtVolts2, NominalCtVolts3 (1629 - 1634)

These 32-bit floating-point registers adjust the nominal full-scale CT voltage. They default to 0.33333 Vac for use with standard CCS current transformers, which output 0.33333 Vac at rated amps. These registers can be used to support CT models that output 0.250 Vac or other values.

The WattNode may be used with milliamp output current transformers. One such option uses a CT with a 40 mA full-scale output combined with a 10 ohm burden resistor inside the meter, resulting in a 0.400 Vac full-scale output.

The CT inputs handle inputs signals up to 0.850 Vac without clipping, but as the signal voltage increases, the allowable crest factor decreases. Therefore, we recommend not exceeding an input voltage of 0.500 Vac at full-scale, which then allows a crest factor of 2.4 without clipping.

CreepLimit (1618)

Also called noise floor. Creep refers to the situation where the wheel on an traditional electromechanical energy meter moves when there is no power being consumed. The WattNode meter has no wheel, but all electrical systems have noise which can cause small readings in the absence of any power consumption. To prevent readings due to noise, if the absolute value of the readings fall below the noise floor, the meter forces the current and the active power values to zero, and stops accumulating active energy. This is performed independently for each meter element.

$$\text{MinimumCurrent} = \text{FullScaleCurrent} * \text{CreepLimit} / 1,000,000$$

$$\text{MinimumPower} = \text{FullScalePower} * \text{CreepLimit} / 1,000,000$$

Any measured current below *MinimumCurrent* is forced to zero. If the current for a meter element is forced to zero, then the active, reactive, and apparent power for that meter element will also be forced to zero. In addition, even if the current is above the noise floor, if the measured active power is below *MinimumPower*, then the active power is forced to zero. *FullScalePower* is the nominal or measured voltage—whichever is higher—multiplied by the **CtAmps** (CT rated amps).

The default **CreepLimit** is 400, which sets the noise floor to 0.04% (400 ppm) or 1/2500th of full-scale current and power. This works well for most installations. Sometimes, in electrically noisy environments, you may see non-zero power readings when the power should be zero. You can adjust the creep limit to eliminate this problem. For example, to adjust the creep limit to 0.2% of full-scale, set **CreepLimit** to 2000.

The WattNode meter may be used for export limiting (zero export) applications, where the meter is being used to prevent the export of power to the utility. For this application, it may be helpful to disable the noise floor by setting **CreepLimit** to 0. The accuracy of very low readings may be poor, but it may be more important to see the sign of the power near zero and to avoid jumps in the readings caused when the signal transitions above or below the noise floor.

VoltsNoiseFloor (1637)

The **VoltsNoiseFloor** register stores the voltage noise floor as a percentage, with a default value of 20%. It is stored in units of 0.1% (decipercent), so a register value of 200 = 20%.

The WattNode meter uses the following logic to determine if a voltage channel is below the voltage noise floor and therefore considered inactive (see [2.3.1 Variables and Terminology](#)).

The WattNode Wide-Range meters have a nominal voltage of 347, corresponding to a three-phase 600 Vac wye service. If the actual line voltage of any channel is higher than 347, the higher voltage is used instead. Multiply this adjusted nominal line voltage by **VoltsNoiseFloor** (as a percentage). If the measured voltage is below this value (normally 69.4 Vac), then force the reported voltage to zero. For any meter element that uses this voltage channel, force the power, energy,

and related measurements to zero. Inactive voltage channels are not included in the average line-to-neutral voltage (**VoltAvgLN**) and the average line-to-line voltage (**VoltAvgLL**).

If necessary, this configuration value may be adjusted to set a different threshold or disabled altogether by writing a value of 0 to the register.

PhaseOffset (1619)

The WNC-series meters use the **PhaseOffset** register to estimate line-to-line voltages. The WND-series meters directly measure line-to-line voltages, so the **PhaseOffset** register is no longer used. It still exists and may be written to for backwards compatibility, but has no effect.

MeterConfig1, MeterConfig2, MeterConfig3 (1624, 1625, 1626)

In the WND series of meters, there are three meter elements associated with the three CT inputs: **CT1**, **CT2**, or **CT3**. Each meter element may be associated with be any of the line-to-neutral voltages (**V_{AN}**, **V_{BN}**, or **V_{CN}**) or any of the line-to-line voltages (**V_{AB}**, **V_{BC}**, or **V_{CA}**). See **2.3.1 Variables and Terminology** and **2.3.2 Metering Configurations**. **MeterConfig1** controls meter element 1; **MeterConfig2** controls meter element 2, and **MeterConfig3** controls meter element 3.

Note: in most cases, it is easier to configure the meter using the **ConnectionType** registers in place of the **MeterConfig** registers.

The possible values for the **MeterConfig** registers are as follow:

- **0** - Disable meter element
- **10** - **V_{AN}** (also called **V_A**)
- **20** - **V_{BN}** (also called **V_B**)
- **30** - **V_{CN}** (also called **V_C**)
- **40** - **V_{AB}**
- **50** - **V_{BC}**
- **60** - **V_{CA}**
- **70** - **V_{BA}** (equal to **-V_{AB}**)
- **80** - **V_{CB}** (equal to **-V_{BC}**)
- **90** - **V_{AC}** (equal to **-V_{CA}**)

By default, the WattNode Wide-Range is configured to behave just like a WNC-series WattNode meter. This is optimized for monitoring three-phase wye circuits, but can be used for any circuit. The default register values are as follow:

- **MeterConfig1** = 10: **CT1** with **V_{AN}** (meter element 1)
- **MeterConfig2** = 20: **CT2** with **V_{BN}** (meter element 2)
- **MeterConfig3** = 30: **CT3** with **V_{CN}** (meter element 3)

Suppose the CTs are rotated one position from the intended conductors, so that the CT connected to **CT1** is monitoring the current flowing through the phase B (**V_{BN}**) conductor, **CT2** is monitoring phase C, and **CT3** is monitoring phase A. This problem can be corrected by configuring **MeterConfig1** = 20, **MeterConfig2** = 30, and **MeterConfig3** = 10.

When a meter element is disabled (**MeterConfig** = 0), the voltage and frequency readings will report normally. The active, reactive, and apparent powers for the meter element will all report zero. The current will report zero. The power factor will report 1.0. All the energy registers for that meter element will stay at their current values. The LED for that meter element will be turned off. If all the meter elements are disabled or measuring below the voltage noise floor (**VoltsNoiseFloor**), then the meter element LEDs will all flash red together every three seconds, indicating no line voltage on any active meter elements (**6.1.13 No Line Voltage**).

ConnectionType (1636)

The **ConnectionType** register is a shortcut to set the **MeterConfig** registers to the most common configurations. As soon as the **ConnectionType** is changed, it will change the associated **MeterConfig** registers. Similarly, if the **MeterConfig** registers are changed, the **ConnectionType** will also change to reflect the new configuration.

Table 10: ConnectionType Details

Connection Type	Name	Meter Element Mapping	Service Types	Notes	Meter Config1	Meter Config2	Meter Config3
0	Custom	Custom	Any	Non-standard connections	varies	varies	varies
1 (default)	Wye	CT1-V _{AN} CT2-V _{BN} CT3-V _{CN}	Any	This type is required for wye service, but may be used for any service type	10	20	30
2	Delta	CT1-V _{AC} CT2-V _{BC}	3-phase, 3-wire delta	CT3 is not used. Works for grounded delta with any phase grounded.	90	50	0
3	Branch circuits	CT1-V _{AN} CT2-V _{AN} CT3-V _{AN}	line-to-neutral	Use for monitoring 1-3 neutral connected branch circuits	10	10	10
4	House and inverter	CT1-V _{AN} CT2-V _{BN} CT3-V _{AB}	See notes	1-phase, 3-wire with neutral for CT1 and CT2. 1-phase, 2-wire without neutral for CT3.	10	20	40
5	Line to Line	CT1-V _{AB}	1-phase, 2-wire, line-to-line	CT2 and CT3 are not used	40	0	0

Writing 0 to **ConnectionType** is not allowed; it will fail with a Modbus exception 03 (illegal data value). If the **MeterConfig** registers are written to any combination not represented by **ConnectionType** values from 1 to 5, then the **ConnectionType** will report a value of 0, indicating a non-standard connection type.

ChangeCounter (1628)

The configuration registers include a change counter that increments by one each time the configuration data is written to non-volatile memory. This will occur each time one or more configuration registers are written with new values. If multiple configuration variables are updated in one Modbus packet, the **ChangeCounter** will only increment by one. But if multiple configuration variables are updated with separate Modbus packets, the **ChangeCounter** will increment by one for each packet.

This counter will stop counting up when it reaches 30,000. This counter is useful for quickly detecting unexpected configuration changes. The **ChangeCounter** is set to zero as the final step in production and cannot be cleared by the end user.

CtMonitoring (1638)

The WattNode Wide-Range meter includes the ability to detect disconnected CTs. A single configuration register, **CtMonitoring**, controls monitoring for all CT inputs. The following monitoring modes are supported:

- 0 - Disable disconnected CT detection. This setting is the default.
- 1 - Detect disconnected CTs. When a disconnected CT is detected, report an error and set associated measurements (integer and floating-point) to 0.

- 2 - Detect disconnected CTs. When a disconnected CT is detected, report an error and set associated integer measurements to 32768 and associated floating-point measurements to NaN (not-a-number).

See [CtStatus1](#), [CtStatus2](#), [CtStatus3](#) (p. 57) for more details.

PtRatio (1639, 1640)

The WND-series WattNode meter includes a potential transformer (PT) ratio configuration. This simplifies using the WattNode with an external PT. PTs are used to step down medium voltage (over 600 V) to a lower voltage (commonly 120 V). For example, if you are monitoring a 4160Y/2400 service (4160 Vac line-to-line, 2400 Vac line-to-neutral), you might use a PT that steps the voltage down by a factor of 20 from 2400 Vac to 120 Vac. In this case, you would program **PtRatio** with a value of 20.0.

The **PtRatio** defaults to 1.0 and may be programmed with any ratio from 0.05 to 300. Ratios less than 1.0 may be used to monitor voltages lower than the WattNode normally supports, such as a 24 Vac system (the **PtRatio** would be 0.2 if you used a PT to step the voltage up to 120 Vac).

When a **PtRatio** other than 1.0 is configured, the following measurements will be scaled by the specified **PtRatio**: all newly accumulated energy (active, reactive, and apparent), power, reactive power, apparent power, all voltage measurements, all demand measurements. For example, suppose the meter is measuring 120 Vac, and 6 kW when the **PtRatio** = 1.0. If you change the **PtRatio** to 10, the readings will change to 1200 Vac and 60 kW.

Any energy accumulated before the **PtRatio** is changed will not be affected by the new **PtRatio**. For example, suppose the meter has been running for six months with **PtRatio** = 1.0 and has accumulated 100 kWh. If you change the **PtRatio** to 10, the accumulated energy will still be 100 kWh the moment after **PtRatio** is changed. But after changing the **PtRatio**, the energy may start to accumulate ten times faster, assuming the new measured power is ten times higher.

OptSignedCurrent (1685)

- **0** - (default) Always report AC current values as positive numbers.
- **1** - Report AC current as a signed (positive or negative) value where the sign of the AC current is set to match the sign of the active power. This matches the behavior of the WNC-series meters.

See also [4.3.10 Current](#).

OptEnergySumMethod (1686)

The **OptEnergySumMethod** can be used to control how positive and negative energy is accumulated (active and reactive) when some meter elements are reporting positive power and others are reporting negative power. Apparent energy is always positive, so it is unaffected by this.

The default register value is 0. The supported values follow.

- **0** - (default) - Positive energy sum registers (**EnergyPosSum**, etc.) accumulate when the sum of the meter element energies for the last 100 milliseconds is positive. Negative energy sum registers (**EnergyNegSum**, etc.) accumulate when the sum of the meter element energies is negative. This matches the behavior of the WNC-series WattNode Modbus meters.
- **1** - Positive energy sum registers accumulate the energy from the meter elements with positive energy for the last 100 milliseconds. Negative energy sum registers accumulate the energy from the meter elements with negative energy.

Internally, energy values are computed every 100 milliseconds, so the determinations for accumulations are performed at this 100 millisecond rate.

As an example, suppose for the previous 100 milliseconds, **Power1** = 18,000 watts, **Power2** = 25,200 watts, **Power3** = -28,800 watts. If we convert these to energy values, we get 0.5 watt-hours, 0.7 watt-hours, and -0.8 watt-hours respectively.

- If **OptEnergySumMethod** = 0 (the default), these energies are all summed together to get 0.4 watt-hours. Since this is positive, **EnergyPosSum** will increase by 0.4 watt-hours and **EnergyNegSum** will not change.
- If **OptEnergySumMethod** = 1, **EnergyPosSum** will increase by 0.5 + 0.7 watt-hours and **EnergyNegSum** will increase by 0.8 watt-hours.

If you use the default energy accumulation method (**OptEnergySumMethod** = 0) but want results like **OptEnergySumMethod** = 1, you can get equivalent results as follows (note: this does not take into account the effect of any meter elements overflowing at 100 GWh).

- **EnergyPosSum** = **EnergyPos1** + **EnergyPos2** + **EnergyPos3**
- **EnergyNegSum** = **EnergyNeg1** + **EnergyNeg2** + **EnergyNeg3**
- **EnergyReacPosSum** = **EnergyReacPos1** + **EnergyReacPos2** + **EnergyReacPos3**
- **EnergyReacNegSum** = **EnergyReacNeg1** + **EnergyReacNeg2** + **EnergyReacNeg3**

DemPerMins, DemSubints (1610, 1611)

The variable **DemPerMins** sets the demand interval in minutes (default 15 minutes), and **DemSubints** sets the number of demand intervals (default 1). The time period of each subinterval is the demand interval divided by the number of subintervals. Setting **DemSubints** to 1 disables subinterval computations. The demand period cannot be longer than 12 hours (720 minutes), and a demand subinterval cannot be less than 1 minutes. The **DemSubints** can be set from 1 to 10.

An example configuration could use a demand period of 60 minutes with 4 subintervals. This would result in a subinterval period of fifteen minutes. Every fifteen minutes, the average power over the last hour would be computed and reported.

ZeroEnergy (1620)

Writing 1 to **ZeroEnergy** will simultaneously set all of the energy registers to zero, except those ending in “NR” (for non-resettable). They can also be set to zero or a preset value by writing the desired value directly to each energy register. If a **ConfigPasscode** has been set, then you must unlock the meter before you can zero or preset the energy.

As a security measure, there are three non-resettable energy registers—**EnergySumNR**, **EnergyPosSumNR**, **EnergyNegSumNR**—that can never be reset to zero.

ZeroDemand (1621)

The **ZeroDemand** register can be written with three values (or zero which does nothing). If a **ConfigPasscode** has been set, then you must unlock the meter before you can zero demand.

- **1** - Zero **DemandMin** and **DemandMax** registers.
- **2** - Zero **Demand**, **Demand1**, **Demand2**, **Demand3** and **DemandApp** registers. Start a new demand interval.
- **3** - Zero **DemandMin**, **DemandMax**, **Demand**, **Demand1**, **Demand2**, **Demand3** and **DemandApp** registers. Start a new demand interval.

4.5 Communication Configuration

If those factory default communication settings need to be changed, these registers can change the Modbus slave address, baud rate, and other communication settings. Take care in doing this, because a mistake could make it difficult to reestablish communication with the meter.

Even when the DIP switches are set to address 0, the meter will still process broadcast messages. This feature can be used to assign a non-zero Modbus address.

If you are using these registers to configure multiple meters, you may want to use the broadcast address (0) so that all meters will update together.

Writing invalid values to any of these registers will result in the Modbus exception “03 - Illegal data value” and the new value will be ignored. See [4.9.1 Modbus Exceptions](#).

ApplyComConfig (1651)

If any of the following communication configuration registers are changed, the new values will not take effect until “1234” (decimal) is written to this register. This makes it easier to configure multiple changes and have them all take effect together.

Reads of ***ApplyComConfig*** will return “1” if there are any pending changes, otherwise “0”.

Address (1652)

This register sets the Modbus slave address to any value from 1 to 247. Be sure to write to the ***ApplyComConfig*** register (see above) to have the change take effect. Set the ***Address*** register to 0 (the default) to have the DIP switch assign the address. See also [2.10.1 Setting the Modbus Address](#) and [1.5 Options](#). Note, the ***Address*** register cannot be set with broadcast Modbus write commands, since this could result in multiple meters with the same address.

BaudRate (1653)

This register specifies the Modbus RS-485 baud rate.

- **0 (default)** - Use the DIP switch to set the baud rate
- **1** - 1,200 baud
- **2** - 2,400 baud
- **3** - 4,800 baud
- **4** - 9,600 baud
- **5** - 19,200 baud
- **6** - 38,400 baud
- **7** - 57,600 baud
- **8** - 76,800 baud
- **9** - 115,200 baud

Be sure to write to the ***ApplyComConfig*** register (see above) to have the change take effect.

See also [1.5.2 Communication Options](#) and [2.10.3 Setting the Baud Rate](#).

ParityMode (1654)

The WattNode Modbus meter defaults to eight data bits, no parity, and one stop bit, but other settings are supported using this register, or with options.

- **0** - (default) 8N1, eight data bits, no parity, one stop bit.
- **1** - 8E1, eight data bits, even parity, one stop bit. **Option EP**
- **2** - 8N2, eight data bits, no parity, two stop bits. **Option 8N2**

Be sure to write to the ***ApplyComConfig*** register (see above) to have the change take effect.

ModbusMode (1655)

- **0** - RTU - This is the default Modbus RTU binary protocol

Prior versions of the WattNode Modbus meters supported the Modbus TCP protocol over the RS-485 interface, but this was non-standard and was removed from the firmware.

ReplyDelay (1656)

ReplyDelay configures a user-defined minimum Modbus reply delay between 0 and 20 milliseconds (the default is 5 milliseconds). This is useful with some Modbus master devices or software that can miss response data if the meter responds to a request too quickly.

Be sure to write to the **ApplyComConfig** register (see above) to have the change take effect.

SerialNumberKey (1657, 1658) and NewAddress (1659)

The WattNode meter includes a feature to allow the Modbus slave address to be assigned by issuing the Write Multiple Registers command to address 0 (the broadcast address). The command must contain the serial number of the meter and the new slave address in one Modbus frame. The serial number is specified as a 32-bit integer value (two registers), while the new Modbus slave address is specified as a 16-bit integer value (one register). This takes effect immediately, without using the **ApplyComConfig** register. This is useful in the following cases:

- To assign the Modbus address of a meter without DIP switches (available on some models).
- To remotely assign the Modbus address when there are two or more devices on the network with conflicting addresses. For example, if you have two meters both set to address 1, then to change one of them, you either have to disconnect one meter or use this feature.
- To remotely assign the Modbus address when you are not sure of the current address of a meter. Since this command uses the broadcast address, it will work with a meter at any address so long as the baud rate and parity settings match.

4.6 Diagnostics

Dummy (0001, 0002)

This is a pair of dummy registers that can be treated as two 16-bit integer or one 32-bit integer value. They are read-only and always return a value of 0. They can be used to scan for the presence of a Modbus device at a particular slave address.

SerialNumber (1701, 1702)

This is a 32-bit long integer register containing the meter's serial number, as printed on the label.

UptimeSecs (1703, 1704)

This 32-bit long integer counts the number of seconds the meter has been running since the last power failure or reset. Resets can be caused by power brownouts or severe errors.

TotalSecs (1705, 1706)

This 32-bit long integer counts the total seconds of meter operation since factory calibration.

Model (1707)

This register can be used to determine the WattNode meter model.

- **510** - This model number is used for all WattNode Wide-Range Modbus models

Version (1708)

This reports the meter's firmware version. WattNode Wide-Range meters use firmware versions starting with 1000, so a firmware version of 1033 is equivalent to version 33 in the WattNode Meter Module. The firmware may be field upgraded (see [4.1.3 Firmware Field Upgrade](#)).

PowerFailCount (1711)

This counts (up to 32767) the number of times power has been cycled on this meter.

CtStatus1, CtStatus2, CtStatus3 (1760, 1761, 1762)

The WattNode Wide-Range includes the ability to detect disconnected CTs. This feature is enabled and configured with the **CtMonitoring (p. 53)** register (by default, it is disabled). Disconnected CT detection works with millivolt output CTs, including Rogowski coils. It does not work with milliamp output CTs.

When monitoring is enabled, the meter can detect if a CT is disconnected within one second. The meter looks for an open circuit on the CT connection to make this determination. It cannot detect

if the CT leads are shorted or if the CT is still connected to the meter, but is no longer around the wire it is supposed to be measuring.

If CT monitoring is enabled and one or more disconnected CTs are detected, the associated measurements for those CTs (active power, reactive power, apparent power, current, and power factor) will be forced to zero or integer measurements to 32768 and floating-point measurements to NaN (not-a-number). For affected meter elements, no additional energy will accumulate; the energy readings will not be changed and will not be forced to a special value.

Detection is disabled for CT inputs whose associated **CtAmps** or **MeterConfig** register is set to 0.

The three **CtStatus** registers are associated with **CT1**, **CT2**, and **CT3**. They report the following values:

- 0 - The CT is connected and operating normally or the CT input is not being monitored and is not indicating a previous disconnect event.
- 1 - The meter currently detects that the CT is disconnected.
- 2 - The CT is connected now, but was previously disconnected. Or the CT was detected as disconnected and then the **CtMonitoring** was changed to turn off disconnect monitoring. Or the CT was detected as disconnected and then the CT was disabled by setting its **CtAmps** to 0 or its **MeterConfig** to 0. The 2 value provides an indication of CT tampering, even if the CT has been reconnected.

The **CtStatus** registers support writes of the value 0. If the **CtStatus** value is 0 or 1, nothing will happen; if the **CtStatus** value is 2, it will be reset to 0 to clear the disconnected indication.

The **CtStatus** values are saved to non-volatile memory and preserved during a power failure.

If detection is enabled, when a CT's status changes from connected to disconnected, the meter will report a **CtDisconnected** error for the affected CT, e.g. **Ct2Disconnected**.

If the meter configuration is locked (generally for security purposes), the **CtMonitoring** register cannot be changed and **CtStatus** cannot be set back to 0.

4.7 Option Information

Options (1709)

This read-only register indicates factory configured options, where each bit of the register indicates the presence or absence of one option. This is more difficult to decode than the individual option registers below.

Bits 1, 4, 5, 7, 8, 9, 15, and 16 are not used by the WattNode Wide-Range meter and always report 0.

- **Bit 2** - 2 (0x0002) - Factory configured even parity for RS-485 communication: **ParityMode** = 1. The parity can be changed by setting the **ParityMode** register to a new value.
- **Bit 3** - 4 (0x0004) - Factory configured baud rate. See **OptBaudRate** below for the configured value. The baud rate can be changed by setting the **BaudRate** register to a new value.
- **Bit 6** - 32 (0x0020) - Factory configured CT rated amps. This can be changed by writing new **CtAmps** values unless the **CtAmps** are locked. See **OptCtAmps1, 2, 3** below for the configured values.
- **Bit 10** - 512 (0x0200) - Factory preset Modbus slave address. See **OptAddress** below for the configured value. The Modbus address can be changed by setting the **Address** register.
- **Bit 11** - 1024 (0x0400) - Factory lock the **CtAmps** registers. **Option L** sets this bit.
- **Bit 12** - 2048 (0x0800) - Factory lock the following configuration settings. **Option L** sets this bit: **CtDirection**, **PtRatio**, **GainAdjust1**, **GainAdjust2**, **GainAdjust3**, **PhaseAdjust1**, **PhaseAdjust2**, **PhaseAdjust3**, **CreepLimit**, **MeterConfig1**, **MeterConfig2**, **MeterConfig3**, **NomCtVolts1**, **NomCtVolts2**, **NomCtVolts3**, **ConnectionType**, and **VoltsNoiseFloor**.

- **Bit 13** - 4096 (0x1000) - Disable all LEDs. This is normally used with **Option NDL** (no LEDs or DIP switches)
- **Bit 14** - 8192 (0x2000) - No DIP switch logic. This is normally used with **Option NDL**.

See also <https://ctlsys.com/s/modbus-option-id/>.

OptCtAmps1, OptCtAmps2, OptCtAmps3 (1724, 1725, 1726)

If **CtAmps1**, **CtAmps2**, and **CtAmps3** were factory configured with **Option CT**, then these contain the values. Otherwise, these will contain 0. These registers are read-only.

OptModbusMode (1727)

This read-only register reports the factory configured value for **ModbusMode**. This is no longer supported and always reports 0.

OptAddress (1728)

This read-only register reports the factory configured Modbus slave address set with **Option AD**. See **Address**.

OptBaudRate (1729)

This read-only register reports the factory configured baud rate. This can be set with **Option BAUD=xxx**, **Option 1.2K**, **Option 2.4K**, **Option 4.8K**, **Option 9.6K**, **Option 19K**, **Option 38K**, **Option 57K**, **Option 76K**, or **Option 115K**. See **BaudRate**.

OptParityMode (1730)

This read-only register reports the factory configured value for the parity mode or 0 if not factory configured. This can be set with **Option EP**. See **ParityMode**.

OptLockedConfig (1737)

This read-only register reports a 1 if **Option L** was ordered, locking **CtAmps**, **CtAmps1**, **CtAmps2**, **CtAmps3**, **CtDirection**, **PtRatio**, **GainAdjust1**, **GainAdjust2**, **GainAdjust3**, **PhaseAdjust1**, **PhaseAdjust2**, **PhaseAdjust3**, **CreepLimit**, **MeterConfig1**, **MeterConfig2**, **MeterConfig3**, **NomCtVolts1**, **NomCtVolts2**, **NomCtVolts3**, **ConnectionType**, and **VoltsNoiseFloor**.

OptFastPower (1738)

The WNC-series meters had an option for fast power. The fast power feature is standard on the WND-series meters, so this option is no longer used and will always return 0.

OptRs485Termination (1739)

The WattNode Wide-Range meter has a new standard feature where DIP switch position 7 is used to enable or disable 120 ohm RS-485 termination. This register returns 1 to indicate that this feature is installed. See **2.9.4 WattNode Internal Termination**.

OptOemFeatures (1740)

This is reserved to indicate the presence of custom OEM features. This register will return 0 if no OEM features are present.

OptNrEnergies (1741)

This option is used for some OEM customers to make all energy registers non-resettable (cannot be reset to zero) and non-presettable (cannot be loaded with starting values). This register will return 1 if present, 0 otherwise. See **ZeroEnergy** in section **4.4 Configuration**.

4.8 Communication Error Counts

The following registers report communication error counts. Each register counts up to 32767 and stops. All of these registers reset to zero when power is cycled or when zero is written to any one of them.

***CrcErrorCount* (1712)**

This is the number of packets with an invalid CRC (cyclic redundancy check).

***FrameErrorCount* (1713)**

This is the number of Modbus packets with framing errors. A framing error can indicate bad baud rate, bad parity setting, RS-485 noise or interference, or an RS-485 bus collision.

***PacketErrorCount* (1714)**

This counts the number of Modbus packets that could not be parsed.

***OverrunCount* (1715)**

This counts the number of times the Modbus input buffer has been overrun. The buffer is 256 bytes and normal requests are less than 80 bytes, so an overrun normally indicates non-Modbus traffic on the RS-485 bus or severe noise on the bus.

4.9 Errors

4.9.1 Modbus Exceptions

If the meter receives an invalid request, it will reply with a Modbus exception code. In most cases, your Modbus master should be able to display the code, which should help you determine the problem. For more information about the problem, check the ***ErrorStatus*** registers, which will provide more detailed error codes.

- **01 - Illegal function code**
 - The Modbus function code is not supported by the WattNode meter.
- **02 - Illegal data address**
 - Attempted to read or write to an invalid register address.
 - Attempted to write to a read-only register. This is common if your addresses are off by one or you request extra registers past the end of a group of registers.
- **03 - Illegal data value**
 - Attempted to write an illegal value to a register.
 - Attempted to write to one of the non-resettable energy registers.
 - Wrote an incorrect passcode.
 - The Modbus packet contained an invalid count of registers or an invalid byte count.
- **04 - Slave device failure**
 - Attempted to write a locked register. Registers may be locked with the ***ConfigPasscode*** or as a factory option. See the ***ErrorStatus*** registers for details.
 - Internal failure.
 - Calibration data lost. The WattNode meter will report a slave device failure until it is recalibrated.
- **06 - Slave device busy**
 - Attempts to unlock the configuration with ***ConfigPasscode*** are locked out for five seconds after entering an invalid passcode.

4.9.2 ErrorStatus Registers

The ErrorStatus registers hold the most recent eight errors or status notifications.

ErrorStatusQueue (1710)

ErrorStatusQueue allows access to the eight most recent errors from a single Modbus register. Each time you read it, you'll get another value (starting with the oldest). When there are no more errors, **ErrorStatusQueue** will report 0. The **ErrorStatusQueue** values are preserved across power failures. **ErrorStatusQueue** is generally best used with unattended data logging, since each error will only be reported once.

ErrorStatus1 - ErrorStatus8 (1716 - 1723)

ErrorStatus1 through **ErrorStatus8** also list the eight most recent errors, but with a few differences. **ErrorStatus1** lists the most recent error or status, while **ErrorStatus8** lists the oldest. Reading these registers will not change the reported values for **ErrorStatus1** through **ErrorStatus8**, so they can be read repeatedly without clearing the values. **ErrorStatus1** through **ErrorStatus8** can all be cleared by writing 0 to any of them. They are **not** preserved across power failures. **ErrorStatus1** through **ErrorStatus8** are generally best used when a person will be looking at the values in real time, because they provide a visual history of recent errors and events and will not be cleared when they are read.

4.9.3 Error Codes

The following lists many of the error and status code values. For any error code not listed below, contact technical support as these can indicate a serious internal error.

- **0**: No error or status messages.

Voltage Input Errors

- **1010**: WARNING: Neutral (**V_N**) input is clipping, possibly due to overvoltage or noise. Accuracy may be affected.
- **1011, 1012, 1013**: WARNING: **V_A**, **V_B**, or **V_C** input respectively is clipping, possibly due to overvoltage or noise. Accuracy may be affected.
- **1020**: WARNING: One or more voltages are exceeding the maximum voltage for this meter model. Disconnect the meter immediately!
- **1030**: WARNING: One or more voltages are exceeding 720 Vac. Disconnect the meter immediately! This is a more severe indication than error 1020, indicating an even higher voltage.
- **1040**: ERROR: Excessive DC offset for the neutral (**V_N**) input. Accuracy may be affected.
- **1041, 1042, 1043**: ERROR: Excessive DC offset for the **V_A**, **V_B**, or **V_C** input respectively. Accuracy may be affected.

Current Transformer Input Errors

- **2000, 2001, 2002**: WARNING: The **CT1**, **CT2**, or **CT3** input respectively is clipping, possibly due to overcurrent, high crest factor load, or noise. Accuracy may be affected.
- **2500, 2501, 2502**: ERROR: Excessive DC offset for the **CT1**, **CT2**, or **CT3** input respectively. Accuracy may be affected.

Energy Overflow Messages

For the following messages, the energy either overflowed +100 GWh or underflowed -100 GWh.

- **3011, 3012, 3013**: INFO: **Energy1**, **Energy2**, or **Energy3** respectively overflowed or underflowed and was reset to 0.
- **3014**: INFO: **EnergySum** overflowed or underflowed and was reset to 0.
- **3015**: INFO: **EnergySumNR** overflowed or underflowed and was reset to 0.
- **3016, 3017, 3018**: INFO: **EnergyNeg1**, **EnergyNeg2**, or **EnergyNeg3** respectively overflowed and was reset to 0.

- **3019:** INFO: *EnergyNegSum* overflowed and was reset to 0.
- **3020:** INFO: *EnergyNegSumNR* overflowed and was reset to 0.
- **3021, 3022, 3023:** INFO: *EnergyPos1*, *EnergyPos2*, or *EnergyPos3* respectively overflowed and was reset to 0.
- **3024:** INFO: *EnergyPosSum* overflowed and was reset to 0.
- **3025:** INFO: *EnergyPosSumNR* overflowed and was reset to 0.
- **3026:** INFO: *EnergyReac1*, *EnergyReacPos1*, or *EnergyReacNeg1* overflowed or underflowed and was reset to 0.
- **3027:** INFO: *EnergyReac2*, *EnergyReacPos2*, or *EnergyReacNeg2* overflowed or underflowed and was reset to 0.
- **3028:** INFO: *EnergyReac3*, *EnergyReacPos3*, or *EnergyReacNeg3* overflowed or underflowed and was reset to 0.
- **3029:** INFO: *EnergyReacSum*, *EnergyReacPosSum*, or *EnergyReacNegSum* overflowed or underflowed and was reset to 0.
- **3031, 3032, 3033:** INFO: *EnergyApp1*, *EnergyApp2*, or *EnergyApp3* overflowed and was reset to 0.
- **3034:** INFO: *EnergyAppSum* overflowed and was reset to 0.

Application Errors and Messages

- **5150:** ERROR: Non-volatile memory write error. Contact technical support.
- **5200:** ERROR: Invalid CRC for calibration stored in non-volatile memory
- **5201:** ERROR: Invalid CRC for configuration stored in non-volatile memory
- **5202:** ERROR: Invalid CRC for measurements stored in non-volatile memory
- **5203:** ERROR: Calibration data was from an earlier firmware version. Unable to restore.
- **5204:** ERROR: Configuration data was from an earlier firmware version. Unable to restore.
- **5205:** INFO: Restored calibration data from an earlier firmware version.
- **5206:** INFO: Restored configuration data from an earlier firmware version.
- **5300, 5301, 5302, 5303:** ERROR: Non-volatile memory communication error
- **5304:** ERROR: Modbus address set to 0. This is the broadcast address and is invalid for a slave device.
- **5309:** WARNING: Invalid baud rate selection. Will use 19,200 baud instead.
- **5310:** ERROR: Could not restore non-volatile measurements from an earlier firmware version.
- **5311:** INFO: Restored non-volatile measurement data from an earlier firmware version.
- **5700:** INFO: Brownout detected, measurements suspended until full power restored.
- **5701:** INFO: Power restored after brownout detected. Measurements resumed.

Modbus Communication Messages

- **7000:** ERROR: Modbus UART receive overrun error.
- **7001:** ERROR: Modbus UART receive framing error.
- **7002:** ERROR: Modbus UART receive parity error.
- **7003:** ERROR: Modbus UART receive noise error.
- **7010:** ERROR: Duplicate Modbus address detected.
- **7011:** ERROR: Bus conflict detected during RS-485 transmit.
- **7012:** ERROR: Another device started transmitting before this meter could respond.
- **7020:** ERROR: Invalid CRC on Modbus message.
- **7021:** ERROR: Invalid Modbus message length.

- **7022:** WARNING: An 0xFF byte or a false start bit was received, likely due to bus noise or an incorrect baud rate.
- **7023:** WARNING: A single byte was received without rest of expected Modbus message.
- **7024:** WARNING: More than one byte was received without rest of expected Modbus message.
- **7060:** ERROR: Modbus receive buffer overrun.
- **7100:** WARNING: Invalid or unsupported Modbus function code.
- **7101:** WARNING: Invalid Modbus register address.
- **7102:** WARNING: Invalid Modbus data value.
- **7110:** WARNING: Factory locked register. Writes not supported.
- **7111:** WARNING: Cannot write to this register without unlocking configuration first.
- **7112:** WARNING: When changing the configuration passcode, the second write did not match the first.
- **7113:** WARNING: When changing the configuration passcode, the two registers were not written contiguously.
- **7114:** WARNING: Passcode attempts blocked for five seconds due to failure.
- **7115:** WARNING: Invalid configuration passcode entered.
- **7116:** WARNING: Invalid attempt to write a factory register.
- **7117:** WARNING: Attempted to write a read-only register.
- **7118:** WARNING: Attempted to write an invalid configuration value.
- **7119:** WARNING: Attempted to write CtAmps on model with locked CT settings.
- **7120:** WARNING: Attempted to change a locked configuration setting on a model with certain settings locked. See **Option L**.
- **7121:** WARNING: Invalid attempt to write a factory register.
- **7122:** WARNING: Invalid factory command.
- **7200:** INFO: An energy register was reset or preset by a write command.
- **7201:** INFO: The factory command was issued to reset the meter.

5 SunSpec Interface and Registers

The WattNode meter (WND-Series) is SunSpec certified. The SunSpec registers are grouped as follows, with detailed information in the following sections.

- **SunSpec Common Registers (Model 1)**
- **SunSpec Energy Meter (Model 203)**: Integer
- **SunSpec Energy Meter (Model 213)**: Floating-point
- **SunSpec CCS Custom Registers (Model 64080)**
- **SunSpec End Registers (Model 65535)**

The WattNode meter includes both the original CCS register sets (see **4.2 Modbus Registers**) and the SunSpec registers. For detailed documentation of registers that appear in both sets, see **4 Modbus Interface and Registers**.

There are functions and registers that appear in the original CCS register sets that are not in the SunSpec registers. You can safely use registers from both sets if you wish.

The SunSpec standard documents register addresses as zero-based. This is different from the Modbus standard which calls for one-based addresses and other CCS registers, which are documented as one-based. To help avoid confusion, the following tables list both conventions.

All multi-register SunSpec registers are big-endian, where the first register contains the most significant 16 bits of data. This is the opposite of the non-SunSpec registers in the WattNode.

In the following tables, default or constant values are indicated with **bold** text.

5.1 Unimplemented SunSpec Registers

Unimplemented measurements or registers are indicated in the tables below with *gray italic* text and marked as “unimplemented”. Unimplemented registers may still be read and will return a special SunSpec value indicating that they are unimplemented.

- For floating-point registers the unimplemented value is 0x7FC00000 (NaN, not-a-number).
- For 16-bit signed integer registers, the unimplemented value is 0x8000.
- For 16-bit unsigned registers, the unimplemented value is 0xFFFF.
- For 32-bit signed registers, the unimplemented value is 0x80000000.
- For 32-bit unsigned registers, the unimplemented value is 0xFFFFFFFF.
- For 32-bit integer energy registers (*acc32*), the unimplemented (or unaccumulated) value is 0x00000000. Because of this requirement, 32-bit integer energies in Model 203 always return at least 1, never 0.

See the SunSpec standard for other types.

5.2 SunSpec Common Registers (Model 1)

The common block identifies the meter as containing SunSpec register blocks and provides general information about the meter.

Registers (0-Based)	Registers (1-Based)	Name	Units / Default	Description
4000, 4001	4001, 4002	SunS	0x53756e53	'SunS' (SunSpec) identifier
4002	4003	ID	1	Common model ID
4003	4004	L	66	SunSpec model register count (length)
4004 - 40019	4005 - 40020	Mn	"Continental Control Systems"	Manufacturer string
40020 - 40035	40021 - 40036	Md	"WND-WR-MB"	Model string
40036 - 40043	40037 - 40044	<i>Opt</i>	<i>unimplemented</i>	Options string (not used)

Registers (0-Based)	Registers (1-Based)	Name	Units / Default	Description
40044 - 40051	40045 - 40052	Vr	"32"	SunSpec interface version number string
40052 - 40067	40053 - 40068	SN		Meter serial number string
40068	40069	DA		Modbus device address
40069	40070	Pad	0x8000	Padding register

5.3 SunSpec Integer Energy Meter (Model 203)

This block contains the three-phase energy meter registers in an integer format. Most of these are single register values, reducing network traffic.

These values need to be scaled for meaningful results using the scale factor registers. Some scale factors are constant while others dynamically change based on the most current measured data. In all cases, the energy registers are reported in units of 0.1 kW, 0.1 kVAR, or 0.1 kVA.

Registers (0-Based)	Registers (1-Based)	Name	Units / Default	Description
40070	40071	ID	203	Wye Three-Phase Meter Integer model ID
40071	40072	L	105	SunSpec model register count (length)
40072	40073	A	scaled amps	Current sum
40073	40074	AphA	scaled amps	RMS current, CT1
40074	40075	AphB	scaled amps	RMS current, CT2
40075	40076	AphC	scaled amps	RMS current, CT3
40076	40077	A_SF		Current scale factor
40077	40078	PhV	scaled volts	Average line-to-neutral voltage RMS for active phases
40078	40079	PhVphA	scaled volts	RMS voltage (line-to-neutral) for phase A
40079	40080	PhVphB	scaled volts	RMS voltage (line-to-neutral) for phase B
40080	40081	PhVphC	scaled volts	RMS voltage (line-to-neutral) for phase C
40081	40082	PPV	scaled volts	Average line-to-line voltage RMS for active phases
40082	40083	PhVphAB	scaled volts	RMS voltage (line-to-line) for phase A-B
40083	40084	PhVphBC	scaled volts	RMS voltage (line-to-line) for phase B-C
40084	40085	PhVphCA	scaled volts	RMS voltage (line-to-line) for phase C-A
40085	40086	V_SF		Voltage scale factor
40086	40087	Hz	0.01 Hz	Power line frequency
40087	40088	Hz_SF	-2	Frequency scale factor
40088	40089	W	scaled watts	Total active power
40089	40090	WphA	scaled watts	Active power, meter element 1
40090	40091	WphB	scaled watts	Active power, meter element 2
40091	40092	WphC	scaled watts	Active power, meter element 3
40092	40093	W_SF		Active power scale factor
40093	40094	VA	scaled VA	Apparent power sum
40094	40095	VAphA	scaled VA	Apparent power, meter element 1
40095	40096	VAphB	scaled VA	Apparent power, meter element 2
40096	40097	VAphC	scaled VA	Apparent power, meter element 3
40097	40098	VA_SF		Apparent power scale factor
40098	40099	VAR	scaled VAR	Total reactive power
40099	40100	VARphA	scaled VAR	Reactive power, meter element 1
40100	40101	VARphB	scaled VAR	Reactive power, meter element 2
40101	40102	VARphC	scaled VAR	Reactive power, meter element 3
40102	40103	VAR_SF		Reactive power scale factor
40103	40104	PF	0.0001	Power factor, average
40104	40105	PFphA	0.0001	Power factor, meter element 1
40105	40106	PFphB	0.0001	Power factor, meter element 2
40106	40107	PFphC	0.0001	Power factor, meter element 3
40107	40108	PF_SF	-4	Power factor scale factor

Registers (0-Based)	Registers (1-Based)	Name	Units / Default	Description
40108, 40109	40109, 40110	TotWhExp	0.1 kWh	Total exported energy
40110, 40111	40111, 40112	TotWhExpPhA	0.1 kWh	Exported energy, meter element 1
40112, 40113	40113, 40114	TotWhExpPhB	0.1 kWh	Exported energy, meter element 2
40114, 40115	40115, 40116	TotWhExpPhC	0.1 kWh	Exported energy, meter element 3
40116, 40117	40117, 40118	TotWhImp	0.1 kWh	Total imported energy
40118, 40119	40119, 40120	TotWhImpPhA	0.1 kWh	Imported energy, meter element 1
40120, 40121	40121, 40122	TotWhImpPhB	0.1 kWh	Imported energy, meter element 2
40122, 40123	40123, 40124	TotWhImpPhC	0.1 kWh	Imported energy, meter element 3
40124	40125	TotWh_SF	2	Real energy scale factor
40125, 40126	40126, 40127	<i>TotVAhExp</i>	<i>unimplemented</i>	Total exported apparent energy
40127, 40128	40128, 40129	<i>TotVAhExpPhA</i>	<i>unimplemented</i>	Exported apparent energy, meter element 1
40129, 40130	40130, 40131	<i>TotVAhExpPhB</i>	<i>unimplemented</i>	Exported apparent energy, meter element 2
40131, 40132	40132, 40133	<i>TotVAhExpPhC</i>	<i>unimplemented</i>	Exported apparent energy, meter element 3
40133, 40134	40134, 40135	TotVAhImp	0.1 kVAh	Total imported apparent energy
40135, 40136	40136, 40137	TotVAhImpPhA	0.1 kVAh	Imported apparent energy, meter element 1
40137, 40138	40138, 40139	TotVAhImpPhB	0.1 kVAh	Imported apparent energy, meter element 2
40139, 40140	40140, 40141	TotVAhImpPhC	0.1 kVAh	Imported apparent energy, meter element 3
40141	40142	TotVAh_SF	2	Apparent energy scale factor
40142, 40143	40143, 40144	TotVArhImpQ1	0.1 kVARh	Total imported reactive energy (Q1)
40144, 40145	40145, 40146	TotVArhImpQ1PhA	0.1 kVARh	Imported reactive energy (Q1), meter element 1
40146, 40147	40147, 40148	TotVArhImpQ1PhB	0.1 kVARh	Imported reactive energy (Q1), meter element 2
40148, 40149	40149, 40150	TotVArhImpQ1PhC	0.1 kVARh	Imported reactive energy (Q1), meter element 3
40150, 40151	40151, 40152	<i>TotVArhImpQ2</i>	<i>unimplemented</i>	Total quadrant 2 reactive energy
40152, 40153	40153, 40154	<i>TotVArhImpQ2PhA</i>	<i>unimplemented</i>	Quadrant 2 reactive energy, meter element 1
40154, 40155	40155, 40156	<i>TotVArhImpQ2PhB</i>	<i>unimplemented</i>	Quadrant 2 reactive energy, meter element 2
40156, 40157	40157, 40158	<i>TotVArhImpQ2PhC</i>	<i>unimplemented</i>	Quadrant 2 reactive energy, meter element 3
40158, 40159	40159, 40160	TotVArhExpQ3	0.1 kVARh	Total exported reactive energy (Q3)
40160, 40161	40161, 40162	TotVArhExpQ3PhA	0.1 kVARh	Exported reactive energy (Q3), meter element 1
40162, 40163	40163, 40164	TotVArhExpQ3PhB	0.1 kVARh	Exported reactive energy (Q3), meter element 2
40164, 40165	40165, 40166	TotVArhExpQ3PhC	0.1 kVARh	Exported reactive energy (Q3), meter element 3
40166, 40167	40167, 40168	<i>TotVArhExpQ4</i>	<i>unimplemented</i>	Total quadrant 4 reactive energy
40168, 40169	40169, 40170	<i>TotVArhExpQ4PhA</i>	<i>unimplemented</i>	Quadrant 4 reactive energy, meter element 1
40170, 40171	40171, 40172	<i>TotVArhExpQ4PhB</i>	<i>unimplemented</i>	Quadrant 4 reactive energy, meter element 2
40172, 40173	40173, 40174	<i>TotVArhExpQ4PhC</i>	<i>unimplemented</i>	Quadrant 4 reactive energy, meter element 3
40174	40175	TotVArh_SF	2	Reactive Energy scale factor
40175, 40176	40176, 40177	Evt		Events
Bit 2	Bit 3	<i>M_EVENT_Power_Failure</i>	<i>unimplemented</i>	Power failure event
Bit 3	Bit 4	<i>M_EVENT_Under_Voltage</i>	<i>unimplemented</i>	Under voltage event
Bit 4	Bit 5	<i>M_EVENT_Low_PF</i>	<i>unimplemented</i>	Low power factor event
Bit 5	Bit 6	<i>M_EVENT_Over_Current</i>	<i>unimplemented</i>	Over current event
Bit 6	Bit 7	<i>M_EVENT_Over_Voltage</i>		Over current voltage (CT) event
Bit 7	Bit 8	<i>M_EVENT_Missing_Sensor</i>		Missing current sensor (CT) event

5.4 SunSpec Floating-Point Energy Meter (Model 213)

This block contains the three-phase energy meter registers in a floating-point format for maximum resolution. This also eliminates the need to scale the results.

Registers (0-Based)	Registers (1-Based)	Name	Units / Default	Description
40177	40178	ID	213	Wye Three-Phase Meter Floating-Point model ID
40178	40179	L	124	SunSpec model register count (length)
40179, 40180	40180, 40181	A	amp	Current sum
40181, 40182	40182, 40183	AphA	amp	RMS current, CT1
40183, 40184	40184, 40185	AphB	amp	RMS current, CT2
40185, 40186	40186, 40187	AphC	amp	RMS current, CT3
40187, 40188	40188, 40189	PhV	volt	Average line-to-neutral voltage RMS for active phases
40189, 40190	40190, 40191	PhVphA	volt	RMS voltage (line-to-neutral) for phase A
40191, 40192	40192, 40193	PhVphB	volt	RMS voltage (line-to-neutral) for phase B
40193, 40194	40194, 40195	PhVphC	volt	RMS voltage (line-to-neutral) for phase C
40195, 40196	40196, 40197	PPV	volt	Average line-to-line voltage RMS for active phases
40197, 40198	40198, 40199	PPVphAB	volt	RMS voltage (line-to-line) for phase A-B
40199, 40200	40200, 40201	PPVphBC	volt	RMS voltage (line-to-line) for phase B-C
40201, 40202	40202, 40203	PPVphCA	volt	RMS voltage (line-to-line) for phase C-A
40203, 40204	40204, 40205	Hz	hertz	Power line frequency
40205, 40206	40206, 40207	W	watt	Total active power
40207, 40208	40208, 40209	WphA	watt	Active power, meter element 1
40209, 40210	40210, 40211	WphB	watt	Active power, meter element 2
40211, 40212	40212, 40213	WphC	watt	Active power, meter element 3
40213, 40214	40214, 40215	VA	VA	Apparent power sum
40215, 40216	40216, 40217	VAphA	VA	Apparent power, meter element 1
40217, 40218	40218, 40219	VAphB	VA	Apparent power, meter element 2
40219, 40220	40220, 40221	VAphC	VA	Apparent power, meter element 3
40221, 40222	40222, 40223	VAR	VAR	Total reactive power
40223, 40224	40224, 40225	VARphA	VAR	Reactive power, meter element 1
40225, 40226	40226, 40227	VARphB	VAR	Reactive power, meter element 2
40227, 40228	40228, 40229	VARphC	VAR	Reactive power, meter element 3
40229, 40230	40230, 40231	PF		Power factor, average
40231, 40232	40232, 40233	PFphA		Power factor, meter element 1
40233, 40234	40234, 40235	PFphB		Power factor, meter element 2
40235, 40236	40236, 40237	PFphC		Power factor, meter element 3
40237, 40238	40238, 40239	TotWhExp	watt-hour	Total exported energy
40239, 40240	40240, 40241	TotWhExpPhA	watt-hour	Exported energy, meter element 1
40241, 40242	40242, 40243	TotWhExpPhB	watt-hour	Exported energy, meter element 2
40243, 40244	40244, 40245	TotWhExpPhC	watt-hour	Exported energy, meter element 3
40245, 40246	40246, 40247	TotWhImp	watt-hour	Total imported energy
40247, 40248	40248, 40249	TotWhImpPhA	watt-hour	Imported energy, meter element 1
40249, 40250	40250, 40251	TotWhImpPhB	watt-hour	Imported energy, meter element 2
40251, 40252	40252, 40253	TotWhImpPhC	watt-hour	Imported energy, meter element 3
40253, 40254	40254, 40255	TotVAhExp	<i>unimplemented</i>	Total exported apparent energy
40255, 40256	40256, 40257	TotVAhExpPhA	<i>unimplemented</i>	Exported apparent energy, meter element 1
40257, 40258	40258, 40259	TotVAhExpPhB	<i>unimplemented</i>	Exported apparent energy, meter element 2
40259, 40260	40260, 40261	TotVAhExpPhC	<i>unimplemented</i>	Exported apparent energy, meter element 3
40261, 40262	40262, 40263	TotVAhImp	VAh	Total imported apparent energy
40263, 40264	40264, 40265	TotVAhImpPhA	VAh	Imported apparent energy, meter element 1
40265, 40266	40266, 40267	TotVAhImpPhB	VAh	Imported apparent energy, meter element 2
40267, 40268	40268, 40269	TotVAhImpPhC	VAh	Imported apparent energy, meter element 3
40269, 40270	40270, 40271	TotVAhImpQ1	VARh	Total imported reactive energy (Q1)

Registers (0-Based)	Registers (1-Based)	Name	Units / Default	Description
40271, 40272	40272, 40273	TotVArhImpQ1phA	VARh	Imported reactive energy (Q1), meter element 1
40273, 40274	40274, 40275	TotVArhImpQ1phB	VARh	Imported reactive energy (Q1), meter element 2
40275, 40276	40276, 40277	TotVArhImpQ1phC	VARh	Imported reactive energy (Q1), meter element 3
40277, 40278	40278, 40279	TotVArhImpQ2	<i>unimplemented</i>	Total quadrant 2 reactive energy
40279, 40280	40280, 40281	TotVArhImpQ2phA	<i>unimplemented</i>	Quadrant 2 reactive energy, meter element 1
40281, 40282	40282, 40283	TotVArhImpQ2phB	<i>unimplemented</i>	Quadrant 2 reactive energy, meter element 2
40283, 40284	40284, 40285	TotVArhImpQ2phC	<i>unimplemented</i>	Quadrant 2 reactive energy, meter element 3
40285, 40286	40286, 40287	TotVArhExpQ3	VARh	Total exported reactive energy (Q3)
40287, 40288	40288, 40289	TotVArhExpQ3phA	VARh	Exported reactive energy (Q3), meter element 1
40289, 40290	40290, 40291	TotVArhExpQ3phB	VARh	Exported reactive energy (Q3), meter element 2
40291, 40292	40292, 40293	TotVArhExpQ3phC	VARh	Exported reactive energy (Q3), meter element 3
40293, 40294	40294, 40295	TotVArhExpQ4	<i>unimplemented</i>	Total quadrant 4 reactive energy
40295, 40296	40296, 40297	TotVArhExpQ4phA	<i>unimplemented</i>	Quadrant 4 reactive energy, meter element 1
40297, 40298	40298, 40299	TotVArhExpQ4phB	<i>unimplemented</i>	Quadrant 4 reactive energy, meter element 2
40299, 40300	40300, 40301	TotVArhExpQ4phC	<i>unimplemented</i>	Quadrant 4 reactive energy, meter element 3
40301, 40302	40302, 40303	Evt		Events
Bit 2	Bit 3	M_EVENT_ Power_Failure	<i>unimplemented</i>	Power failure event
Bit 3	Bit 4	M_EVENT_ Under_Voltage	<i>unimplemented</i>	Under voltage event
Bit 4	Bit 5	M_EVENT_ Low_PF	<i>unimplemented</i>	Low power factor event
Bit 5	Bit 6	M_EVENT_ Over_Current	<i>unimplemented</i>	Over current event
Bit 6	Bit 7	M_EVENT_ Over_Voltage		Over current voltage (CT) event
Bit 7	Bit 8	M_EVENT_ Missing_Sensor		Missing current sensor (CT) event

5.5 SunSpec CCS Custom Registers (Model 64080)

This block of registers includes WattNode functionality that is not part of the standard SunSpec energy meter models. All of these and additional custom functionality can also be accessed through the regular WattNode Modbus register set. The most important configuration and diagnostic functions are repeated here in a SunSpec complaint format for convenience.

Registers (0-Based)	Registers (1-Based)	Name	Units / Default	Description
40303	40304	ID	64080	WattNode Meter Points model ID
40304	40305	L	29	SunSpec model register count (length)
40305	40306	CtAmps1	5	CT1 rated current (0 to 30000)
40306	40307	CtAmps2	5	CT2 rated current (0 to 30000)
40307	40308	CtAmps3	5	CT3 rated current (0 to 30000)
40308	40309	CtDirections	0	Bit field to optionally invert CT orientations (0 to 7)
Bit 0	Bit 1	REVERSE_CT1	0	Reverse CT1
Bit 1	Bit 2	REVERSE_CT2	0	Reverse CT2
Bit 2	Bit 3	REVERSE_CT3	0	Reverse CT3
40309, 40310	40310, 40311	PtRatio	1.0	Potential transformer ratio (0.05 to 300)
40311	40312	Averaging	1	Configure measurement averaging
40312	40313	ConnectionType	1	Mains connection type

Registers (0-Based)	Registers (1-Based)	Name	Units / Default	Description
40313	40314	MeterConfig1	10	Configure voltage paired with CT1
40314	40315	MeterConfig2	20	Configure voltage paired with CT2
40315	40316	MeterConfig3	30	Configure voltage paired with CT3
40316	40317	CtMonitoring	0	Enable monitoring for disconnected CTs
40317	40318	CtStatus1		Disconnection status for CT1
40318	40319	CtStatus2		Disconnection status for CT2
40319	40320	CtStatus3		Disconnection status for CT3
40320, 40321	40321, 40322	NominalCtVolts1	0.33333	Full-scale voltage for CT1
40322, 40323	40323, 40324	NominalCtVolts2	0.33333	Full-scale voltage for CT2
40324, 40325	40325, 40326	NominalCtVolts3	0.33333	Full-scale voltage for CT3
40326	40327	ErrorStatus1		Newest error or status code
40327	40328	ErrorStatus2		Error or status code
40328	40329	ErrorStatus3		Error or status code
40329	40330	ErrorStatus4		Error or status code
40330	40331	ErrorStatus5		Error or status code
40331	40332	ErrorStatus6		Error or status code
40332	40333	ErrorStatus7		Error or status code
40333	40334	ErrorStatus8		Oldest error or status code

5.6 SunSpec End Registers (Model 65535)

This short block of registers indicates the end of the SunSpec registers in the WattNode meter.

Registers (0-Based)	Registers (1-Based)	Name	Units / Default	Description
40334	40335	ID	65535	End model ID
40335	40336	L	0	SunSpec model register count (length)

6 LED Indications and Troubleshooting

6.1 Power LED Diagnostics

The WattNode meter includes multi-color power diagnostic LEDs for each meter element to help verify correct operation and diagnose incorrect wiring. The LEDs are marked **P_{CT1}**, **P_{CT2}**, and **P_{CT3}** on the label for meter elements and CTs 1, 2, and 3. The following diagrams and descriptions explain the various LED patterns and their meanings. Values like “1.0 sec” and “3.0 sec” indicate the time the LEDs are lit in seconds. In the diagrams, sometimes the colors are abbreviated: R = red, G or Grn = green, Y = yellow.

6.1.1 Normal Startup

On initial power-up, the LEDs will all light up in a red, yellow, green sequence. After this startup sequence, the LEDs will show the status, such as [6.1.2 Normal Operation](#) below.

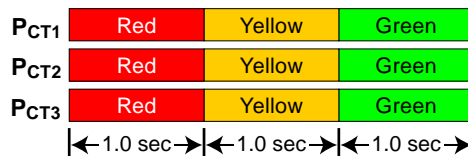

6.1.2 Normal Operation

During normal operation, when positive power is measured on a meter element, the LED for that meter element will flash green. Typical flash rates are shown below.



Table 11: LED Flash Rates vs. Power

Percent of Full-Scale Power	LED Flash Rate	Flashes in 10 Seconds
100%	5.0 Hz	50
50%	3.6 Hz	36
25%	2.5 Hz	25
10%	1.6 Hz	16
5%	1.1 Hz	11
1% (and lower)	0.5 Hz	5

6.1.3 Zero Power

For each meter element, if line Vac is present, but the measured power is below the minimum that the meter will measure, then the meter will display solid green. See [CreepLimit](#).



6.1.4 Inactive Meter Element

If a particular meter element is inactive (See [2.3.1 Variables and Terminology](#)), the LED for that element will stay off. Meter elements are inactive if the line voltage is below the voltage noise floor (see [VoltsNoiseFloor](#)), the [MeterConfig](#) register for a meter element is set to 0 (inactive), or the [CtAmps](#) register for a meter element is set to zero.

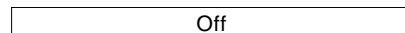

6.1.5 Negative Power

If one or more of the meter element LEDs are flashing red, it indicates negative power (flowing into the grid) on those meter elements. The rate of flashing indicates magnitude of negative power (see [Table 11: LED Flash Rates vs. Power](#) above). This can happen for the following reasons:

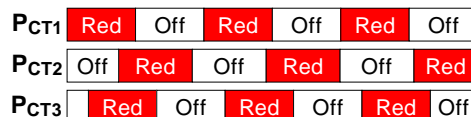

- This is a bidirectional power measurement application, such as a photovoltaic system, where negative power occurs whenever you generate more power than you consume.

- The current transformer (CT) for this meter element was installed backwards on the current carrying conductor or the white and black wires for the CT were reversed at the meter. This can be solved by flipping the CT on the conductor or swapping the white and black wires at the meter. Alternatively, you can use the configuration register **CtDirections (1607)** to reverse the polarity of one or more of the CTs.
- The CT wires are connected to the wrong inputs, for example, if the CT wires for **CT2** and **CT3** are swapped or the CT wires are rotated one voltage phase. This can be corrected by fixing the wiring or setting the **MeterConfig** registers to compensate.
- The **ConnectionType** or **MeterConfig** registers are configured incorrectly.

Note: if all three LEDs are flashing red and they always turn on and off together, like the diagram for **6.1.12 Low Supply Voltage** below, then the meter is experiencing an error or low line voltage, not negative power.

6.1.6 Erratic Flashing

If the LEDs are flashing slowly and erratically, sometimes green, sometimes red, this generally indicates one of the following:

P _{CT1}	Off	Grn	Off	Red	Off
P _{CT2}	Red	Off	Green	Off	Red
P _{CT3}	Grn	Off	Red	Grn	Red

- Earth ground is not connected to the meter green screw terminal.
- Voltage is connected for a meter element, but the current transformer is not connected, or the CT has a loose connection.
- In some cases, particularly for a circuit with no load, this may be due to electrical noise. This is not harmful and can generally be disregarded, provided that you are not seeing substantial measured power when there should not be any. Try turning on the load to see if the erratic flashing stops.

To fix this, try the following:

- Make sure earth ground is connected.
- If there are unused current transformer inputs, install a shorting jumper for each unused CT (a short length of wire connected between the white and black dots marked on the label). Alternately, you can set **MeterConfig** = 0 for any unused meter elements.
- If there are unused voltage inputs (on the green screw terminal block), connect them to neutral or earth ground.
- If you suspect noise may be the problem, try moving the meter away from the source of noise. Also try to keep the CT wires as short as possible and cut off excess wire.

6.1.7 Meter Not Operating

It should not be possible for all three LEDs to stay off when the meter is powered. If all LEDs are off, the meter is either not receiving sufficient voltage to operate, or is malfunctioning and needs to be returned for service. Verify that the proper line voltages are applied to the meter.

P _{CT1}	Off
P _{CT2}	Off
P _{CT3}	Off

6.1.8 Meter Error

When the meter experiences an internal error, it lights all LEDs red for three seconds or longer. Check the **ErrorStatus** registers to determine the exact error. If this happens repeatedly, return the meter for service.

P _{CT1}	Red
P _{CT2}	Red
P _{CT3}	Red

← 3.0 sec →

6.1.9 Bad Calibration

If this pattern is displayed constantly, it indicates that the meter has detected bad calibration data and must be returned for service.

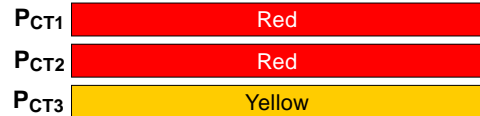

6.1.10 Line Voltage Too High

Whenever the meter detects line voltages greater than the power supply or the measurement absolute maximum voltages (see [7.5.1 Power Supply](#)), it displays a fast red/green flashing for all three meter element LEDs. In the case, **the meter may be damaged! If you see continuous over-voltage flashing, disconnect the meter immediately!** Check that the model and voltage rating is correct for the electrical service.

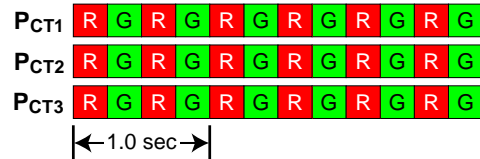

6.1.11 Bad Line Frequency

If the meter detects a power line frequency below 45 Hz or above 70 Hz, it lights all the LEDs yellow for at least three seconds. The LEDs stay yellow until the line frequency returns to normal. During this time, the meter should continue to accurately measure power. This can occur in the presence of extremely high noise, such as if the meter is too close to an unfiltered variable frequency drive.

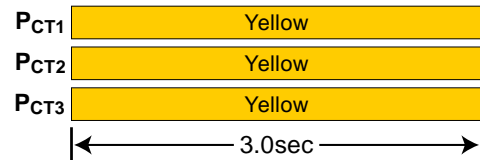

6.1.12 Low Supply Voltage

If the power supply voltage is too low for the meter, the meter may exhibit one or more of the following behaviors:

- Display a continuous red, yellow, red pattern on the meter element LEDs to indicate low supply voltage.
- All LEDs go black if the voltage is too low for the meter to operate.
- The LEDs may flash erratically as the meter sporadically loses power.

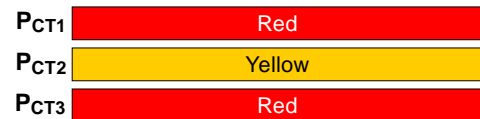

If you suspect a low supply voltage, use a DMM (multimeter) to check the applied line voltages.

6.1.13 No Line Voltage

If the measured line voltages for the active meter elements is less than the voltage noise floor (approximately 70 Vac), then the meter briefly flashes all three status LEDs together every three seconds. See [2.3.1 Variables and Terminology](#) and [VoltsNoiseFloor \(1637\)](#) for more information about the voltage noise floor.

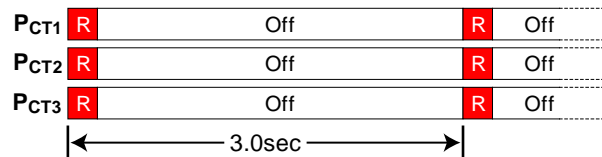

Note: it is possible to configure the meter elements (using the [ConnectionType](#) or [MeterConfig](#) registers), so that the meter elements are monitoring voltages that are near zero, even though higher voltage AC is being applied to other terminals. For example, if [MeterConfig1](#) = 10 (V_{AN}), [MeterConfig2](#) = 10 (V_{AN}), and [MeterConfig3](#) = 10 (V_{AN}), and at the same time, V_{AN} is near zero, the no line voltage LED pattern will appear, even if 230 Vac is applied to V_B and V_C.

6.1.14 Other Fixed Pattern

If you see any other steady (non-flashing) pattern, contact Continental Control Systems for support.

6.2 Measurement Troubleshooting

There are a variety of possible measurement problems. The following procedure should help narrow down the problem. This assumes you can communicate with the meter and read registers. You can combine these diagnostic steps with the status LED diagnostics above.

6.2.1 Voltage Troubleshooting

Start by checking the reported voltages (***VoltAN***, ***VoltBN***, ***VoltCN***, ***VoltAB***, ***VoltBC***, ***VoltCA***) for active (connected) phases. Make sure the voltages match the expected line-to-neutral or line-to-line voltages. If not, check the actual voltages present at the meter with a DMM (multimeter).

- If one or more voltages incorrectly report zero, then you either have a wiring problem or something is wrong with the meter. Verify the actual voltages with a DMM (multimeter). In some cases with delta circuits, one phase may be grounded and will read zero volts (see [2.4.7 Grounded Leg Service](#)).
- If any voltages read higher than expected, then check your wiring. If the wiring is correct, contact support.
- If the voltages are close to the measured (or expected) values, continue with the next step.

6.2.2 Power Troubleshooting

Next, check the measured power for each active meter element (***Power1***, ***Power2***, ***Power3***). If possible, estimate or measure the actual power. Also, make sure the load you are measuring is currently on.

- If one or more active meter elements are reporting zero power, then the problem is probably one of the following:
 - There is no active power (the load is off) or the power is too low to measure (generally less than 1/2000th of full-scale).
 - CT wires are not securely connected.
 - The CT or its wires are damaged.
 - There is strong electrical interference, as might occur if the meter is in very close proximity to a variable speed drive (also called variable frequency drive or inverter).
 - The meter is not working correctly: try swapping it with a replacement meter.
- If one or more active meter elements are reporting negative power:
 - The current transformer has been installed backward on the conductor being measured or the white and black wires have been swapped where they enter the WattNode meter (at the black six-position screw terminal block). CTs are marked with either an arrow or a label saying "This side toward source". If the arrow or label are not oriented toward the source of power (generally the panel or breaker), then the measured current will be inverted and the power negative. This can be fixed either by flipping the CT orientation, by swapping the white and black wires at the CT input terminal block, or configuring the ***CtDirections*** register to flip the CT polarity in software.
 - The line voltage inputs (green screw terminal) are not matched up with the CTs inputs. For example, the CT1 current transformer is around the V_B conductor. This can be fixed by correcting the wiring error or by configuring the ***MeterConfig*** registers.
 - This may be normal if you are measuring in an environment where power may be consumed or generated, such as a house with PV panels.
- If one or more meter elements are reporting low or high power:
 - Make sure the ***CtAmps*** configuration is set correctly for your current transformers.
 - The current transformers may have a rated current too high or too low for your application. CTs should be used between 1% and 120% of their rated current for best results. They generally work with reduced accuracy as low as 0.5% to 0.1% of rated current and up to 150% to 200% of rated current.

- The CTs may not be installed properly.
- The voltage phases (green screw terminal block) are not matched up with the CTs (black screw terminal block). The easiest way to determine this is to skip ahead to the next troubleshooting section: **6.2.3 Power Factor and Reactive Power Troubleshooting**.
- Interference from a variable frequency or variable speed drive: VFD, VSD, inverter, or the like. Generally, these drives should not interfere with the WattNode meter, but if they are in very close proximity, or if the CT leads are long, interference can occur. Try moving the WattNode meter at least three feet (one meter) away from any VFDs. Use short CT leads if possible. **NEVER** install the meter downstream of a VFD: the varying line frequency and extreme noise will cause problems!
- Our current transformers can only measure AC currents. Strong DC currents will saturate the magnetic core of the CT, preventing an accurate measurement of the AC current. The overwhelming majority of AC powered electric devices do not draw significant DC current, so this is a rare occurrence.
- Loads with a high current crest factor (ratio of the peak current to the RMS current) can cause clipping in the measurement circuitry if the CT is operating near or above its rated current, resulting in lower than expected readings. You can check for this with a handheld power quality analyzer that can measure crest factor (CF) or by trying a CT with a higher rated current, which should allow the meter to measure the peak current accurately.
- The CTs may be malfunctioning. If possible, use a current clamp to verify the current, then use a DMM (multimeter) to measure the AC voltage between the white and black wires from the CT (leave them connected to the meter during this test). At rated current, the CT output voltage should equal 0.333 Vac (333 millivolts AC). At lower currents, the voltage should scale linearly, so at 20% of rated current, the output voltage should be $0.20 * 0.333 = 0.0666$ Vac (66.6 millivolts AC).
- If possible, verify the expected power with a handheld power meter. Current clamps can be useful to very roughly estimate the power, but since they measure current, not power, the estimated power (voltage times current) may be off by 50% or more.

6.2.3 Power Factor and Reactive Power Troubleshooting

The measured power factor and reactive power are very useful in determining if there is a mismatch between the voltage and current measurement inputs on the meter. For example, if **CT1** is measuring the **V_B** conductor.

However, this troubleshooting is complicated because different loads have different typical power factors and the power factor can vary significantly for some devices, like motors, as a function of the mechanical load on the motor. Here are some general guidelines:

- **Motors, idling or with a light load:** power factor from 0.2 to 0.8, positive reactive power.
- **Motors, normal or heavy load:** power factor from 0.6 to 0.8, positive reactive power.
- **Motor with VSD:** power factor between 0.5 and 0.9.
- **Incandescent lighting:** power factor near 1.0, small negative reactive power.
- **Florescent lighting:** power factor between 0.4 and 1.0.
- **Electrical heating:** power factor near 1.0.
- **Office equipment:** power factor between 0.6 and 1.0, reactive power may be positive or negative.

Negative power factor values either indicate you are generating power (as with a PV system) or that the CTs are reversed.

If the measured power factor or reactive power appears to be outside the normal ranges, this most commonly indicates that the voltage and current inputs on the meter are not connected properly, although some loads fall outside the normal ranges. Check the following:

- The CT connected to the **CT1** terminal is installed around the line wire being measured by the **V_A** Vac terminal (green terminal block).
- The CT connected to the **CT2** terminal is installed around the line wire being measured by the **V_B** Vac terminal (green terminal block).
- The CT connected to the **CT3** terminal is installed around the line wire being measured by the **V_C** Vac terminal (green terminal block).

Note: In some cases, this may not apply because the *ConnectionType* or *MeterConfig* registers have been used to reconfigure the meter elements. In this case, it is still important to correctly match up the CTs and voltage inputs, but the pairing may be different than described above.

If this does not solve your problem, contact technical support for more assistance.

6.3 Modbus Communication Diagnostics

The “**Com**” LED indicates many Modbus communication conditions by lighting green, yellow, or red. Other Modbus errors are indicated by returning a Modbus exception response to the master and by saving an error code to the *ErrorStatus* registers.

See [4.9 Errors](#) for more details.

6.3.1 Modbus Idle

Whenever the Modbus network is idle, the **Com** LED will stay off.

6.3.2 Received Packet / Sending Response

Every time the meter receives a properly formatted packet it will light the LED green for 200 milliseconds.

Green	Off
0.2s	

6.3.3 Other Modbus Activity

If the WattNode meter sees packets on the bus addressed to other devices, it will light the LED yellow for 200 milliseconds or longer if the packet duration is longer than 200 milliseconds.

Yellow	Off
0.2s	

6.3.4 Modbus Address Zero Invalid

Modbus address 0 is reserved for broadcast

messages, so if the DIP switch is set for address zero, the **Com** LED will light red continuously and the meter will not respond to any Modbus packets.

Red

6.3.5 Invalid Modbus Packet

The meter will light the **Com** LED red for one second for any of the following errors (the *ErrorStatus* registers will also be set, but depending on the problem you may not be able to read register values).

- **CRC error:** this could indicate noise on the RS-485 bus.
- **Framing error:** this normally indicates a bad baud rate or noise on the RS-485 bus. This can happen if you have the “**A-**” and “**B+**” wires swapped. **Note:** some RS-485 PC interfaces label “A” and “B” the opposite of the WattNode meter or just use “+” and “-” indications.
- **Buffer overrun error:** the packet was longer than 256 bytes.

Red	Off
1.0sec	

- **Parsing error:** the packet could not be correctly parsed as a Modbus packet.

6.3.6 Invalid Request

If the WattNode Modbus meter receives a **valid packet**, but with an **invalid request** (see below), then the meter will respond with a Modbus exception message and store an error in the ***ErrorStatus*** registers. Because the packet was valid, **Com** LED will flash green for 200 milliseconds.

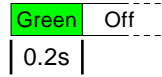

6.3.7 Diagnostic Registers

If Modbus communications are working, but with intermittent problems, check the following diagnostic registers (see **4.6 Diagnostics** for details): ***ErrorStatus***, ***CrcErrorCount***, ***FrameErrorCount***, ***PacketErrorCount***, ***OverrunCount***.

7 Specifications

7.1 Models

There is only one WattNode Wide-Range Modbus model:

- WND-WR-MB

Unlike the WNC-series meters, all WND-WR-MB meters provide revenue-grade accuracy, so there is no need to order “RWND-WR-MB”. If you need a certificate of calibration, there is a separate item you must order: WN-CAL-CERT.

See [1.5 Options](#) for options descriptions.

7.2 Accuracy

The following accuracy specifications do not include errors caused by the current transformer accuracy or phase angle errors. “Rated current” is the current that generates a CT output voltage of 0.33333 Vac or equivalent milliamp output.

Unless otherwise noted, all accuracy specifications assume the following conditions:

Line voltage: 100 to 690 Vac

Power factor (PF): 1.0

Frequency : 48 - 62 Hz

Ambient Temperature: 23°C ± 5°C

CT Current: 1% - 100% of rated current

Table 12: WattNode Accuracy

Parameter	Test Conditions	Typ	Max	Unit
EnergySum, Energy1, 2, 3 ⁽¹⁾ (active energy)	elapsed time ⁽²⁾ >= 30 s	±0.2	±0.5	%
EnergySum, Energy1, 2, 3; PF 0.5 to 0.9	elapsed time ⁽²⁾ >= 30 s	±0.4	±0.8	%
PowerSum, Power1, 2, 3 (active power)	averaging >= 1 s	±0.3	±0.5	%
PowerSum, Power1, 2, 3; PF 0.5 to 0.9	averaging >= 1 s	±0.5	±1.0	%
VoltAN, BN, CN, VoltAB, BC, CA (RMS voltage)	averaging >= 1 s	±0.3	±0.5	%
Current1, 2, 3 (RMS current)	averaging >= 1 s	±0.25	±0.5	%
Freq (frequency)	averaging >= 1 s	±50 ±3	±150 ±9	ppm mHz
PowerFactor1, 2, 3	averaging >= 1 s PF > 0.5	±0.5	±1.0	%
EnergyReacSum, EnergyReac1, 2, 3 (reactive energy)	elapsed time ⁽²⁾ >= 30 s PF < 0.9	±0.6	±1.5	%
PowerReacSum, PowerReac1, 2, 3 (reactive power)	averaging >= 1 s PF < 0.9	±0.6	±1.5	%
EnergyAppSum, EnergyApp1, 2, 3 (apparent energy)	elapsed time ⁽²⁾ >= 30 s	±0.3	±0.5	%
PowerAppSum, PowerApp1, 2, 3 (apparent power)	averaging >= 1 s	±0.3	±0.5	%

⁽¹⁾ Note: when parameters are written like Energy1, 2, 3, this means Energy1, Energy2, and Energy3.

⁽²⁾ Note: This indicates that energy accuracy should be evaluated over a period of 30 seconds or longer.

All models

Meet the ANSI C12.1-2008 and ANSI C12.20-2010 class 0.5 accuracy requirements, excluding errors caused by attached current transformers.

Meet the ANSI C12.1-2008 standard for revenue metering with CTs when used with class 0.6 or better current transformers.

Meet the ANSI C12.20-2010 class 0.5 standard for revenue metering with CTs when used with class 0.2 and class 0.3 current transformers.

7.3 Measurement

Update Rate: Approximately 0.1 second, adjusted to an integer number of AC line cycles. All measurements are performed at this rate. All measurement registers except the energy registers can update as fast as every 0.1 seconds depending on the configuration of the Averaging register. The energy registers are updated from the internal values every 1.0 second.

Start-Up Time: ≤ 1 second after the supply voltage is applied

Default CT Phase Angle Correction: 0.0 degrees. Current transformers (CTs) may have a phase angle errors, which can be corrected using the *PhaseAdjust1*, *PhaseAdjust2*, *PhaseAdjust3* registers.

Creep Limit: Defaults to 0.04% (1/2500th) of full-scale. For more information, see *CreepLimit (1618)* in **4.4 Configuration**.

Nominal Voltage: 347.0 Vac line-to-neutral (this value is used by the *VoltsNoiseFloor*, *CreepLimit*, and *PowerIntScale*)

7.4 Modbus Communication

Protocol: Modbus RTU (binary)

Register Sets: CCS WattNode registers, SunSpec models 1, 203, 213, 64080, and 65535

Baud Rates: 1200, 2400, 4800, 9600, 19200, 38400, 57600, 76800, and 115200

Duplex: Half (two-wire plus common)

Parity:

Standard: N81 (no parity, eight data bits, one stop bit)

Optional: E81 (even parity, eight data bits, one stop bit)

Optional: N82 (no parity, eight data bits, two stop bits)

Modbus Buffer: 256 bytes

Communication Response Time: 5 to 25 milliseconds (may be longer immediately after a Modbus write command, while the meter saves values to non-volatile memory).

7.5 Electrical

Voltage, Maximum: 690 Vac. Exceeding this limit on any of the voltage inputs (**V_N**, **V_A**, **V_B**, and **V_C** screw terminals) can damage the WattNode and void the warranty.

7.5.1 Power Supply

Power Supply Voltage Range, Nominal: 100 to 600 Vac

Power Supply Input Terminals: **V_N**, **V_A**, **V_B** (the meter supply can operate line-to-neutral and line-to-line)

Power Supply Voltage, Minimum: 85 Vac (below this voltage the meter may not operate, but will not be damaged)

Power Supply Typical Watts: see graph below

Power Supply Typical Voltage-Amperes: see graph below

Power Supply Typical Power Factor: 0.6

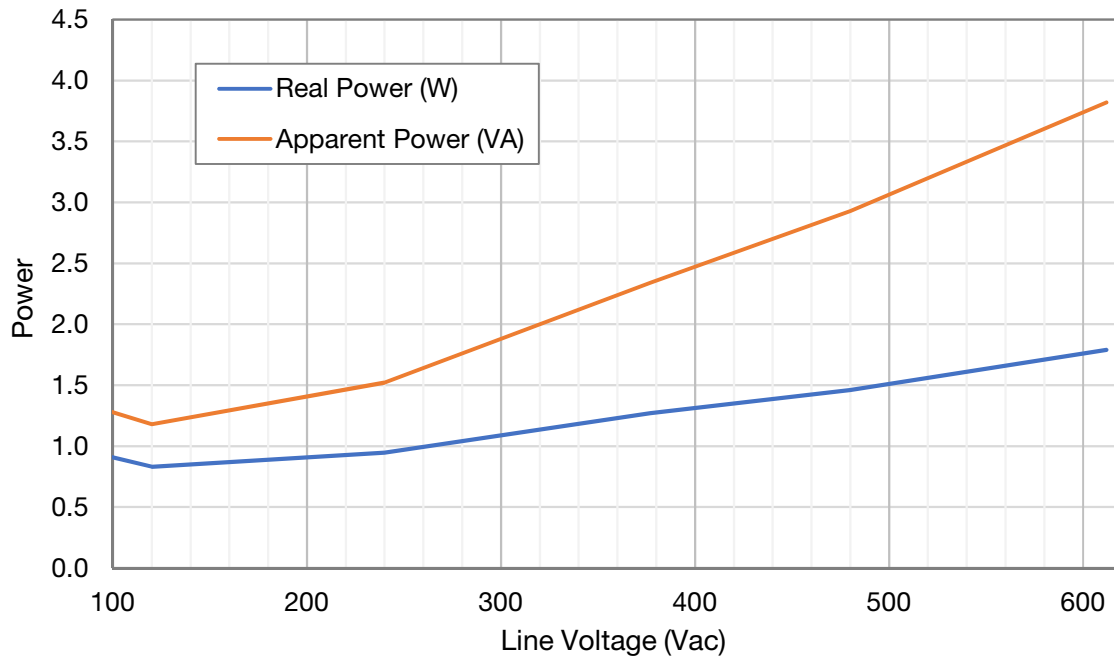

Figure 16: WND-WR-MB Typical Power Consumption

7.5.2 General Electrical

Line Frequency: 45 to 65 Hz

Line-to-Neutral Vac, Nominal: 90 to 347 Vac

Line-to-Line Vac, Nominal: 120 to 600 Vac

Over-Current Limit: 200% of rated current. Exceeding 200% of rated current will not harm the meter, but the current and power will not be measured accurately.

Maximum Surge: EN 61000-4-5: 2kV, ANSI C12.1 combination wave: 6kV, 1.2/50 μ s – 8/20 μ s

Measurement Category: The line voltage measurement terminals on the meter are rated for CAT III, 600 Vac

Measurement Category III is for measurements performed in the building installation. Examples are measurements on distribution boards, circuit-breakers, wiring, including cables, busbars, junction boxes, switches, socket-outlets in the fixed installation, and equipment for industrial use and some other equipment, for example, stationary motors with a permanent connection to the fixed installation.

7.5.3 Current Transformer Inputs

Voltage Mode:

Nominal Input Voltage (At CT Rated Current): 0.33333 Vac RMS

Absolute Maximum Input Voltage: 5.0 Vac RMS

Input Impedance at 50-60 Hz: 23 k Ω

Current Mode:

Nominal Input Current (At CT Rated Current): 40 mA RMS

Absolute Maximum Input Current: 200 mA RMS

Input Impedance at 50-60 Hz: 10 Ω

7.5.4 EIA RS-485 Modbus Interface

RS-485 Output Isolation: 4500 Vac RMS

Driver Output:

Voltage (Open Circuit): ± 6 Vdc maximum

Voltage (54 Ω load): ± 1.5 Vdc minimum

Current (54 Ω load): ± 60 mA typical

Rise Time (54 Ω || 50 pF load): 900 nS typical

Receiver Input:

Common-Mode Voltage Range: -7 Vdc to +12 Vdc maximum

Sensitivity: ± 200 mV

Bus Load: 1/8 unit load (up to 256 WattNode meters per subnet)

Failsafe Modes: bus open, bus shorted, bus idle

7.6 Regulatory

Safety: meets European Parliament Directive 2014/35/EU: Low Voltage Directive

UL Listed (U.S. and Canada), file number E359088

UL / IEC 61010-1, 3rd Edition

CAN/CSA-C22.2 No. 61010-1-12, 3rd Edition

FCC: Class B, FCC Part 15, radiated and conducted emissions

EMC: meets European Parliament Directive 2014/30/EU: Electromagnetic Compatibility

EMC Requirements: EN 61326-1: 2013, industrial locations

Radiated Emissions: CISPR / EN 55011, Class B

Conducted Emissions: CISPR / EN 55011, Class B

Electrostatic Discharge: EN/IEC 61000-4-2: (B) Self-Recovering

Radiated RF Immunity: EN/IEC 61000-4-3: (A) No Degradation

Electrical Fast Transient / Burst: EN/IEC 61000-4-4: (A) No Degradation

Surge Immunity: EN/IEC 61000-4-5: (A) No Degradation

Conducted RF Immunity: EN/IEC 61000-4-6: (A) No Degradation

Power Frequency H-field Immunity: EN/IEC 61000-4-8: (A) No Degradation

Voltage Dips, Interrupts: EN/IEC 61000-4-11: (B) Self-Recovering

RoHS Compliant: European Parliament Directive 2011/65/EU: Hazardous Substances

7.7 Environmental

Operating Temperature: -40°C to $+80^{\circ}\text{C}$ (-40°F to 176°F)

Operating Humidity: non-condensing, 5 to 90% relative humidity (RH) up to 40°C , decreasing linearly to 50% RH at 55°C .

Operating Altitude: Up to 3000 m (9842 ft)

Pollution: POLLUTION DEGREE 2 - Normally only non-conductive pollution; occasionally, a temporary conductivity caused by condensation must be expected

Degree of Protection: IP40 (>1 mm solids, no protection from liquids)

Indoor Use: Suitable for indoor use

Outdoor Use: Suitable for outdoor use if mounted inside an electrical enclosure (Hammond Mfg., Type EJ Series) rated NEMA 3R or 4 (IP 66)

7.8 Mechanical

7.8.1 Connectors

Connectors: Euroblock pluggable terminal blocks

Green: up to 12 AWG or 2.5 mm², 600 V

Black: up to 12 AWG or 2.5 mm², 300 V

7.8.2 Standard Enclosure

Enclosure: High impact, ABS/PC plastic

Flame Resistance Rating: UL 94V-0, IEC FV-0

Overall Size: 6.02 in. × 3.35 in. × 1.50 in. (153 mm × 85.1 mm × 38.0 mm)

Weight: 233 g (8.2 oz)

8 Warranty

All products sold by Continental Control Systems, LLC (CCS) are guaranteed against defects in material and workmanship for a period of five years from the original date of shipment. CCS's responsibility is limited to repair, replacement, or refund, any of which may be selected by CCS at its sole discretion. CCS reserves the right to substitute functionally equivalent new or serviceable used parts.

This warranty covers only defects arising under normal use and does not include malfunctions or failures resulting from: misuse, neglect, improper application, improper installation, water damage, acts of nature, lightning, product modifications, alterations or repairs by anyone other than CCS.

Except as set forth herein, CCS makes no warranties, expressed or implied, and CCS disclaims and negates all other warranties, including without limitation, implied warranties of merchantability and fitness for a particular purpose.

8.1 Limitation of Liability

In no event shall CCS be liable for any indirect, special, incidental, punitive or consequential damages of any kind or nature arising out of the sale or use of its products whether such liability is asserted on the basis of contract, tort or otherwise, including without limitation, lost profits, even if CCS has been advised of the possibility of such damages.

Customer acknowledges that CCS's aggregate liability to Customer relating to or arising out of the sale or use of CCS's products, whether such liability is asserted on the basis of contract, tort or otherwise, shall not exceed the purchase price paid by Customer for the products in respect of which damages are claimed. Customer specifically acknowledges that CCS's price for the products is based upon the limitations of CCS's liability set forth herein.