

MODBUS[®] /TCP PROTOCOL GUIDE

For use with:
SNAP PAC R-Series Controller
SNAP PAC S-Series Controller
SNAP PAC EB Brains
OPTOEMU Sensors
SNAP Ethernet I/O Units
SNAP Simple I/O Units
SNAP Ultimate I/O Units
E1 I/O Units
E2 I/O Units
G4EB2/G4D32EB2 Brains

Form 1678-161109—November 2016

OPTO 22
Automation made simple.

43044 Business Park Drive • Temecula • CA 92590-3614
Phone: 800-321-OPTO (6786) or 951-695-3000
Fax: 800-832-OPTO (6786) or 951-695-2712
www.opto22.com

Product Support Services

800-TEK-OPTO (835-6786) or 951-695-3080
Fax: 951-695-3017
Email: support@opto22.com
Web: support.opto22.com

Modbus/TCP Protocol Guide
Form 1678-161109—November 2016
Copyright © 2007–2016 Opto 22.
All rights reserved.
Printed in the United States of America.

The information in this manual has been checked carefully and is believed to be accurate; however, Opto 22 assumes no responsibility for possible inaccuracies or omissions. Specifications are subject to change without notice.

Opto 22 warrants all of its products to be free from defects in material or workmanship for 30 months from the manufacturing date code. This warranty is limited to the original cost of the unit only and does not cover installation, labor, or any other contingent costs. Opto 22 I/O modules and solid-state relays with date codes of 1/96 or newer are guaranteed for life. This lifetime warranty excludes reed relay, SNAP serial communication modules, SNAP PID modules, and modules that contain mechanical contacts or switches. Opto 22 does not warrant any product, components, or parts not manufactured by Opto 22; for these items, the warranty from the original manufacturer applies. Refer to Opto 22 form 1042 for complete warranty information.

Wired+Wireless controllers and brains are licensed under one or more of the following patents: U.S. Patent No(s). 5282222, RE37802, 6963617; Canadian Patent No. 2064975; European Patent No. 1142245; French Patent No. 1142245; British Patent No. 1142245; Japanese Patent No. 2002535925A; German Patent No. 60011224.

Opto 22 FactoryFloor, *groov*, Optomux, and Pamux are registered trademarks of Opto 22. Generation 4, *groov* Server, ioControl, ioDisplay, ioManager, ioProject, ioUtilities, *mistic*, Nvio, Nvio.net Web Portal, OptoConnect, OptoControl, OptoDataLink, OptoDisplay, OptoEMU, OptoEMU Sensor, OptoEMU Server, OptoOPCServer, OptoScript, OptoServer, OptoTerminal, OptoUtilities, PAC Control, PAC Display, PAC Manager, PAC Project, PAC Project Basic, PAC Project Professional, SNAP Ethernet I/O, SNAP I/O, SNAP OEM I/O, SNAP PAC System, SNAP Simple I/O, SNAP Ultimate I/O, and Wired+Wireless are trademarks of Opto 22.

ActiveX, JScript, Microsoft, MS-DOS, VBScript, Visual Basic, Visual C++, Windows, and Windows Vista are either registered trademarks or trademarks of Microsoft Corporation in the United States and other countries. Linux is a registered trademark of Linus Torvalds. ARCNET is a registered trademark of Datapoint Corporation. Modbus is a registered trademark of Schneider Electric, licensed to the Modbus Organization, Inc. Wiegand is a registered trademark of Sensor Engineering Corporation. Allen-Bradley, CompactLogix, ControlLogix, MicroLogix, SLC, and RSLogix are either registered trademarks or trademarks of Rockwell Automation. CIP and EtherNet/IP are trademarks of ODVA.

groov includes software developed by the OpenSSL Project for use in the OpenSSL Toolkit. (<http://www.openssl.org>)

All other brand or product names are trademarks or registered trademarks of their respective companies or organizations.

Opto 22
Automation Made Simple.

Table of Contents

Chapter 1: Introduction	1
About This Guide	1
Contents	2
Other Guides You May Need	2
For Help	3
About Opto 22 Devices	3
Opto 22 Devices as Modbus Master	4
Communication Example	4
Overview of Modbus Communication	5
Understanding Opto 22 and Modbus Differences	6
Function Codes Supported	6
Report Slave ID Function Code	7
Communication Packet	7
Exception Errors	7
Chapter 2: Configuring I/O for Modbus/TCP	9
Introduction	9
Module and Point Positions on I/O Units	9
SNAP I/O Units	9
SNAP Example 1: Reading/Writing Digital Point States to Coils and Inputs	10
SNAP Example 2: Reading/Writing Analog Point Values to Input and Holding Registers	11
E1 and E2 I/O Units	13
E1 Example: Reading/Writing Digital Point States to Coils and Inputs	14
E2 Example: Reading/Writing Analog Point Values to Input and Holding Registers ..	14
G4EB2 I/O Units	14
G4EB2 brains with G4 modules	15
G4EB2 brains with Quad Pak modules	16
Configuring I/O Points	17
Configuring I/O Points for SNAP Analog/Digital I/O Units	17
SNAP I/O Point Types	17
Examples of Configured SNAP I/O Points for Modbus	24
Configuring I/O Points for SNAP Digital-Only I/O Units	25

Using I/O Point Features	25
SNAP Digital I/O Point Features	26
Latches	26
Counters	26
SNAP Analog I/O Point Features	26
Scaling	27
Minimum and Maximum Values	27
Offset and Gain	27
E1 Digital Point Features	27
Latches	27
Counters	28
E2 Analog Point Features	28
Scaling E2 Analog Points	28
Minimum and Maximum Values	28
Offset and Gain	29
A Note on Analog Counts	29

Chapter 3: The Modbus Memory Map31

Introduction	31
Coils number.....	31
Inputs	33
Input Registers	34
Holding Registers	35
Notes for All Analog Modules	36
Analog Module Register Table	37
Change in reporting analog counts for E2	38
Notes for High-Density Digital (HDD) Modules.....	38
High-Density Digital Module Register Table	39

Chapter 4: Accessing Other Data41

Introduction	41
Why Access Other Data?	41
Accessible Data	41
Modbus Master Requirements	42
Determining Modbus Unit ID and Register.....	42
Finding OptoMMP Memory Map Addresses	42
Converting OptoMMP Memory Map Addresses	45
Example: Reading an OptoMMP Memory Map Address	46
Example: Writing to an OptoMMP Memory Map Address	46

Index 47

1: Introduction

About This Guide

This guide shows you how to use Modbus/TCP to communicate with Opto 22 SNAP Ethernet-based controllers and I/O units. The following Opto 22 products can communicate using Modbus/TCP:

I/O units with the following processors:

SNAP-PAC-R1	E1
SNAP-PAC-R1-B	E2
SNAP-PAC-R1-FM	G4EB2
SNAP-PAC-R1-W	G4D32EB2
SNAP-PAC-R2	G4D32EB2-UPG
SNAP-PAC-R2-FM	SNAP-B3000-ENET
SNAP-PAC-R2-W	SNAP-ENET-RTC
SNAP-PAC-EB1	SNAP-ENET-S64
SNAP-PAC-EB1-FM	SNAP-ENET-D64
SNAP-PAC-EB1-W	SNAP-UP1-ADS
SNAP-PAC-EB2	SNAP-UP1-M64
SNAP-PAC-EB2-FM	SNAP-UP1-D64
SNAP-PAC-EB2-W	

Standalone controllers:

SNAP-PAC-S1	SNAP-PAC-S2
SNAP-PAC-S1-FM	SNAP-PAC-S2-W
SNAP-PAC-S1-W	

Energy monitoring units:

OPTOEMU-SNR-3V	OPTOEMU-SNR-DR1
	OPTOEMU-SNR-DR2

Opto 22's groov Box and groov Server also communicate with Modbus/TCP devices, but this guide does not apply to *groov*. This guide discusses Opto 22 products that act as a Modbus slave; *groov* acts as a Modbus master. For information about using Modbus/TCP devices with *groov*, see form 2027, [groov Build and View User's Guide](#).

This guide assumes that you already understand Modbus/TCP programming and communications. Use this guide in conjunction with the Modbus/TCP specification, available at <http://www.modbus.org/specs.php>. The *Modicon Modbus Protocol Reference Guide* may also be useful; at the time this guide was written it was available from Schneider Electric at

<http://www.schneider-electric.com/download/hk/en/details/2052374-Modbus-Protocol-Reference-Guide-Version-J/?reference=PIMBUS300>

IMPORTANT: Before you start, be sure to read form 2011, the *Using Modbus Devices with Opto 22 Products* technical note, available on our website. The technical note will help you get started with Modbus and troubleshoot communication.

NOTE: For energy monitoring units, this guide is only a reference. Find primary information for Modbus communication in form 1958, [OptoEMU Sensor Communication Guide](#).

Contents

This guide includes the following:

Chapter 1: Introduction—Supported Modbus function codes, communication packet, and exception codes, as well as details about this guide and Opto 22 Product Support.

Chapter 2: Configuring I/O for Modbus/TCP—How to configure and use input/output (I/O) points and point features with Modbus/TCP.

Chapter 3: The Modbus Memory Map—Coils, inputs, input registers, and holding registers used by most Opto 22 devices.

Chapter 4: Accessing Other Data—Ways to access data not included in coils, inputs, and registers.

Other Guides You May Need

As you work with the Opto 22 devices using Modbus/TCP, you may need to refer to the following additional guides. All are available on our website, www.opto22.com. The easiest ways to locate one are to click the link below or to search on its form number.

For this information	See this guide	Form #
Modbus basics and troubleshooting	Using Modbus Devices with Opto 22 Products	2011
Installing and using SNAP PAC R-series controllers	SNAP PAC R-Series Controller User's Guide	1595
Installing and using SNAP PAC S-series controllers	SNAP PAC S-Series Controller User's Guide	1592
Installing and using SNAP PAC brains	SNAP PAC Brain User's Guide	1690
Installing and using OPTOEMU Sensors	OptoEMU Sensor User's Guide	1932
Communicating with OPTOEMU Sensors using Modbus and Modbus/TCP	OptoEMU Sensor Communication Guide	1958
Installing and using E1 and E2 brain boards	E1 and E2 User's Guide	1563
Installing and using SNAP Ethernet, SNAP Simple, and SNAP Ultimate I/O units	SNAP Ethernet-Based I/O Units User's Guide	1460
Writing custom applications using the OptoMMP protocol over Ethernet; finding OptoMMP memory map addresses	OptoMMP Protocol Guide	1465
Configuring and working with SNAP PAC controllers and brains using the software tool PAC Manager	PAC Manager User's Guide	1704

For this information	See this guide	Form #
Configuring and working with both SNAP PAC and legacy I/O units using the software tool PAC Manager	PAC Manager User's Guide, Legacy Edition	1714

For Help

If you have problems using Modbus/TCP with Opto 22 products and cannot find the help you need in this guide or on our website, contact Opto 22 Product Support.

Phone:	800-TEK-OPTO (800-835-6786 toll-free in the U.S. and Canada) 951-695-3080 Monday through Friday, 7 a.m. to 5 p.m. Pacific Time	<i>NOTE: Email messages and phone calls to Opto 22 Product Support are grouped together and answered in the order received.</i>
Fax:	951-695-3017	
Email:	support@opto22.com	
Opto 22 website:	www.opto22.com	

When calling for technical support, you can help us help you *faster* if you can provide the following information to the Product Support engineer:

- Opto 22 hardware part numbers or models that you're working with
- Software version (available by clicking Help > About in the application's menu bar)
- Firmware version
- Specific error messages you saw
- Version of your computer's operating system

About Opto 22 Devices

Opto 22 devices that can communicate using Modbus/TCP include Ethernet-based I/O units, SNAP PAC standalone controllers, OptoEMU Sensor energy monitoring units, and *groov*.

The term *I/O unit* refers to one Opto 22 mounting rack populated with I/O modules and an I/O processor (on-the-rack controller, brain, or brain board; see processor part numbers on [page 1](#)). Each I/O module can contain 1 to 32 I/O points, depending on the module.

Using Modbus/TCP, you can send data to and from each of these I/O points. The communication method is described in this chapter. The coils, inputs, and registers you use for I/O point data are described in [Chapter 3](#).

Opto 22 Ethernet-based devices use a memory-mapped protocol (OptoMMP), which is based on the IEEE 1394 standard. The coils, inputs, and registers described in [Chapter 3](#) are mapped to areas within the I/O processor's memory map.

Although the most common use for communication between Modbus systems and Opto 22 systems is sending and receiving I/O point data on an I/O unit, you may also need to obtain other data, from either an I/O unit or a controller. This other data, such as Scratch Pad data, exists in the I/O unit's or controller's memory map and can be accessed by following the steps in [Chapter 4](#).

In all these cases the Opto 22 device acts as the Modbus slave.

Opto 22 Devices as Modbus Master

This guide covers the use of Opto 22 devices as Modbus slaves. Opto 22 controllers and OptoEMU Sensor energy monitoring units can also act as a Modbus master. *groov* always acts as a Modbus master.

- For *groov*, see form 2027, [groov Build and View User's Guide](#).
- For OptoEMU Sensors, see form 1958, [OptoEMU Sensor Communication Guide](#).
- For Opto 22 controllers, download a free integration kit from our website, www.opto22.com. Choose the Modbus integration kit you need based on your controller and network.

Before you begin, be sure to read form 2011, the [Using Modbus Devices with Opto 22 Products](#) technical note.

Communication Example

The diagram on the following page shows an example of how an Opto 22 system might communicate with a Modbus system. This is just one example; many other configurations are possible.

In this example, the SNAP-PAC-S1 standalone controller runs a PAC Control strategy that monitors and controls the I/O units and all the I/O points on them. Simultaneously, the Modbus system can exchange data with the Opto 22 system.

Because the two Ethernet network interfaces on the SNAP-PAC-S1 are independent interfaces with separate IP addresses, the Opto 22 control network can be segmented from the computer network. This example shows this type of segmentation, as the PC is attached to Ethernet switch #1 and the control network is on Ethernet switch #2.

Because the Modbus/TCP hardware is also on switch #2, it can send data to and from every I/O unit shown. In this example the Modbus/TCP software running on the PC, attached to switch #1, can access data only from the controller; for instance, it might access data placed in the controller's Scratch Pad by the PAC Control strategy.

CAUTION: *If you use PAC Control, use the Modbus/TCP integration kit or be careful that Modbus writes to I/O points do not conflict with strategy logic.*

If you are not using PAC Control, Modbus/TCP hardware or software on the same network segment as I/O units can provide full control for I/O points.

Modbus Communication Example

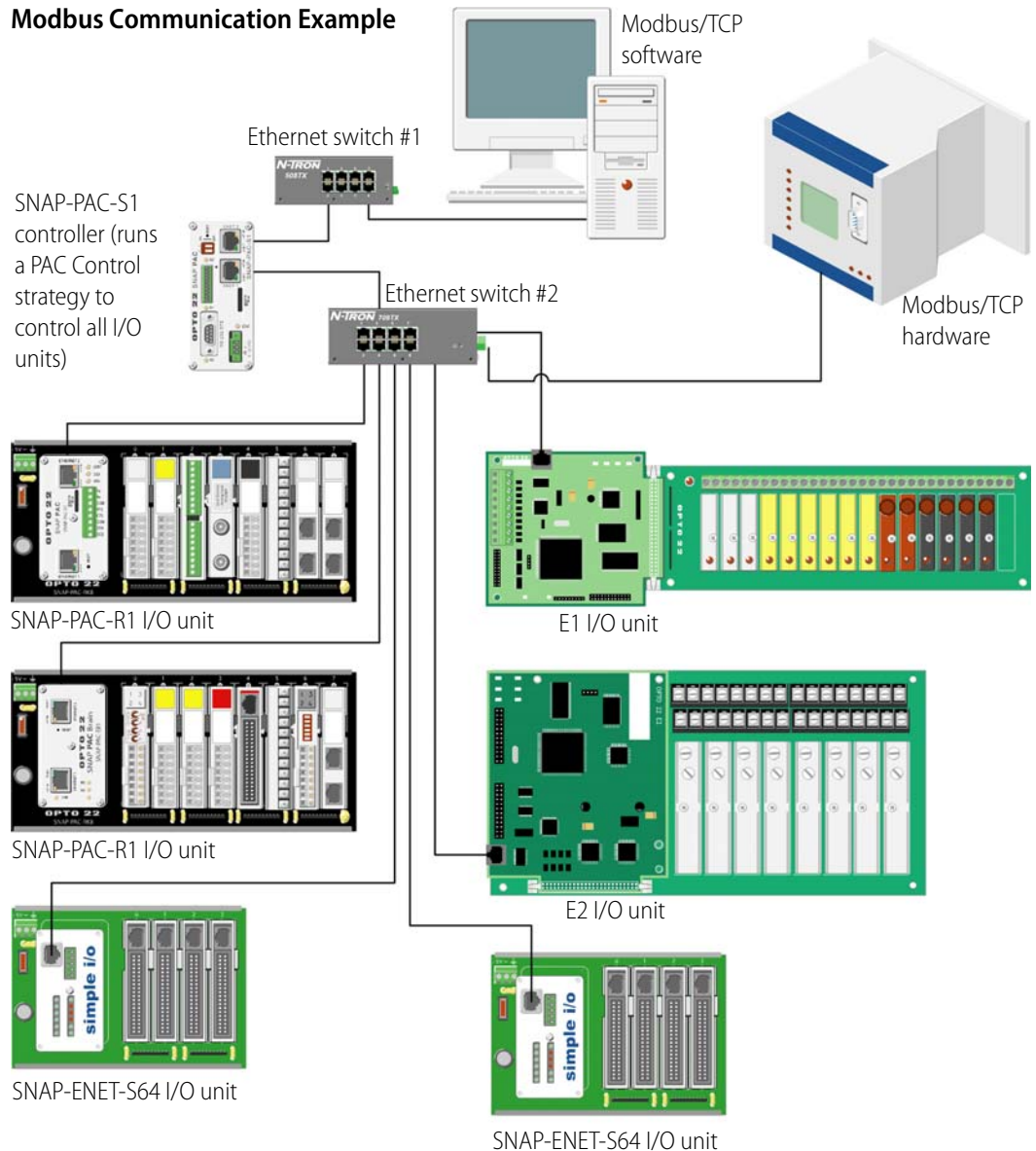

Overview of Modbus Communication

Communicating with Opto 22 Ethernet-based devices using Modbus/TCP requires four basic steps: connect, configure, read/write, and disconnect.

When opening a TCP/IP connection to the system, you normally use port 502. (This is the default port; it can be changed for security reasons using PAC Manager. See form1704, [PAC Manager User's Guide](#), for more information.)

Opto 22 devices can handle a maximum of eight connections from Modbus masters (requires firmware R9.4B or higher—or, for E1 and E2, firmware R1.2a; lower firmware versions handle a maximum of two connections).

For all coils, inputs, and registers listed in [Chapter 3](#), use a slave ID (Unit ID) of 1 for the device.

Understanding Opto 22 and Modbus Differences

Notice that Opto 22 module and point numbers on the I/O unit commonly start numbering at 0 (zero), while Modbus coil or input numbers start at 1; so Modbus coil 1 or input 1 usually equals Opto 22 point 0 on the module in position 0 on the rack.

Also notice the way Opto 22 uses Modbus registers:

Modbus Registers	Opto 22 Use	Modbus Registers	Opto 22 Use
Coils	Digital outputs	Register inputs	Analog inputs
Inputs	Digital inputs	Holding registers	Analog outputs and miscellaneous

Function Codes Supported

Opto 22 devices use the Modbus function code plus the register number to map to the appropriate memory map address in the brain.

NOTE: Data on a SNAP PAC standalone controller can be accessed only through advanced Modbus programming. See Chapter 4: Accessing Other Data for information.

The following table shows Modbus function codes supported for I/O units. (Function codes for a specific I/O unit depend on the analog/digital capabilities of the brain.)

Modbus Function Code (Hex)	Definition	Opto 22 Equivalent
01	Read coil status	Read digital output
02	Read input status	Read digital input
03	Read holding registers	Read analog output
04	Read input registers	Read analog input
05	Force single coil	Turn on/off one digital output
06	Preset single register	Write one analog output
0F	Force multiple coils	Turn on/off multiple digital outputs
10	Preset multiple registers	Write multiple analog outputs
11	Report slave ID	Report hardware and firmware revision levels (See below: “Report Slave ID Function Code”)

Report Slave ID Function Code

Function code 0x11, Report slave ID, returns data bytes as shown in the following table.

Bytes 1 and 2 are always in the formats shown. The 0x22 in byte 1 indicates an Opto 22 brain; 0xFF appears in byte 2 because, since the brain is a slave, it is always running.

Byte 1	Byte 2	Bytes 3–6				Bytes 7–10				Bytes 11–14			
Slave ID	Run Indicator	Hardware Version*				Kernel Version*				Loader Version*			
		Major	Minor	A/B/R	Letter	Major	Minor	A/B/R	Letter	Major	Minor	A/B/R	Letter
0x22	0xFF	0x01	0x01	0x01	0x01	0x01	0x01	0x01	0x01	0x01	0x01	0x01	0x01

* Hardware, kernel (firmware), and loader versions each include four bytes, indicating:

1st byte—major version number

2nd byte—minor version number

3rd byte—revision type: 0=A (alpha), 1=B (beta), 2=R (release)

4th byte—version letter: 0=a, 1=b, 2=c, 3=d, and so on

Example: 0x03080200 would indicate version R3.8a

Communication Packet

As the Modbus/TCP specification requires, Opto 22 devices use a Modbus packet inside a TCP/IP packet. The Modbus checksum is not used; instead, the Ethernet TCP/IP link layer checksum guarantees data. The size of the packet is limited to 256 bytes. The packet follows the standard Modbus/TCP format.

Note: You can read a maximum of 127 input or holding registers in one command 03 or 04.

Exception Errors

If an error occurs, standard Modbus exception codes are returned in the Modbus packet. The following table, reprinted from the *Modicon Modbus Protocol Reference Guide*, shows the Modbus exception codes. If you need more information, see the Modicon documentation.

Code	Name	Meaning
01	ILLEGAL FUNCTION	The function code received in the query is not an allowable action for the slave.
02	ILLEGAL DATA ADDRESS	The data address received in the query is not an allowable address for the slave.
03	ILLEGAL DATA VALUE	A value contained in the query data field is not an allowable value for the slave.
04	SLAVE DEVICE FAILURE	An unrecoverable error occurred while the slave was attempting to perform the requested action.
05	ACKNOWLEDGE	The slave has accepted the request and is processing it, but a long duration of time will be required to do so. This response is returned to prevent a time-out error from occurring in the master. The master can next issue a Poll Program Complete message to determine if processing is completed.
06	SLAVE DEVICE BUSY	The slave is engaged in processing a long-duration program command. The master should retransmit the message later when the slave is free.

Code	Name	Meaning
07	NEGATIVE ACKNOWLEDGE	The slave cannot perform the program function received in the query. This code is returned for an unsuccessful programming request using function code 13 or 14 decimal. The master should request diagnostic or error information from the slave.
08	MEMORY PARITY ERROR	The slave attempted to read extended memory, but detected a parity error in the memory. The master can retry the request, but service may be required on the slave device.

2: Configuring I/O for Modbus/TCP

Introduction

This chapter includes the following:

- Illustrations of module and point positions on I/O units and how they relate to coils, inputs, and registers in Modbus/TCP (below)
- I/O point configuration required for communication with Modbus/TCP systems ([page 17](#))
- Point features and how to use them with Modbus/TCP ([page 25](#)).

Module and Point Positions on I/O Units

Opto 22 I/O units are zero-based: that is, the first module position on the rack is position 0, and the first point on each module is point 0. The number of points on a module can vary from one to 32, depending on the module family and part number. Because of this numbering and variation, reading and writing point data to coils, inputs, and registers can be complex.

Module and point positions are different if you are using SNAP I/O units (see below), E1/E2 I/O units (see [page 13](#)), or G4EB2 I/O units (see [page 14](#)).

SNAP I/O Units

I/O units whose I/O processor's part number begins with "SNAP" are called SNAP I/O units. For example, I/O units with a SNAP-PAC-R1, SNAP-EB1, or SNAP-ENET-S64 as the I/O processor are all SNAP I/O units.

SNAP mounting racks may hold 4, 8, 12, or 16 I/O modules. Although these modules may be analog, digital, or serial, only analog and digital I/O apply to Modbus/TCP communication. Each module contains 1 to 32 points (channels), depending on the module. Examples of modules are shown in the following diagram.

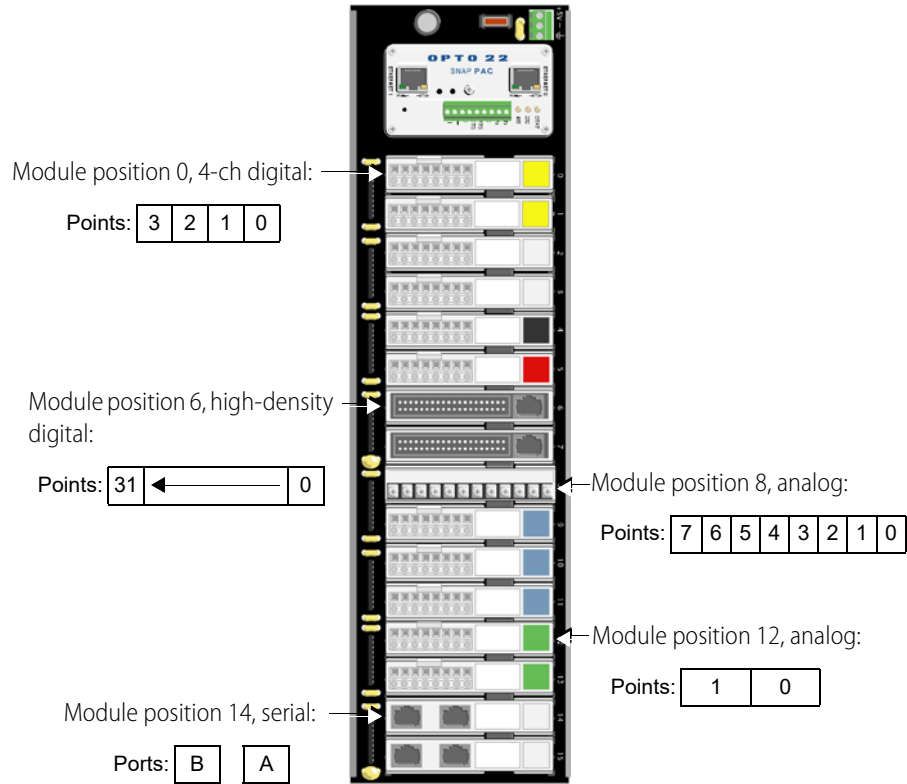

The following examples show how SNAP module and point numbers relate to Modbus coils, inputs, and registers.

SNAP Example 1: Reading/Writing Digital Point States to Coils and Inputs

The following table shows the coils or inputs you would read or write to for point states on SNAP 4-channel digital modules.

NOTE: For high-density digital modules (digital modules with more than four points), different coils and inputs are used. See "Input Registers" on page 34 and "Holding Registers" on page 35. Also see "Notes for High-Density Digital (HDD) Modules" on page 38.

Reading/Writing 4-Channel Digital Point States to Coils and Inputs

SNAP 4-Channel Digital I/O		
Module	Point	Coil/Input
0	0	1
	1	2
	2	3
	3	4
1	0	5
	1	6
	2	7
	3	8
2	0	9
	1	10
	2	11
	3	12
3	0	13
	1	14
	2	15
	3	16
4	0	17
	1	18
	2	19
	3	20
5	0	21
	1	22
	2	23
	3	24

SNAP 4-Channel Digital I/O		
Module	Point	Coil/Input
6	0	25
	1	26
	2	27
	3	28
7	0	29
	1	30
	2	31
	3	32
8	0	33
	1	34
	2	35
	3	36
9	0	37
	1	38
	2	39
	3	40
10	0	41
	1	42
	2	43
	3	44

SNAP 4-Channel Digital I/O		
Module	Point	Coil/Input
11	0	45
	1	46
	2	47
	3	48
12	0	49
	1	50
	2	51
	3	52
13	0	53
	1	54
	2	55
	3	56
14	0	57
	1	58
	2	59
	3	60
15	0	61
	1	62
	2	63
	3	64

SNAP Example 2: Reading/Writing Analog Point Values to Input and Holding Registers

Analog point values in input and holding registers are in the form of 32-bit floats. Because Modbus registers contain only 16 bits, two consecutive registers are used to read or write the data for one point. The following table shows the input or holding registers you would use to read or write analog point values, depending upon the number of points on the module (one, two, or four points).

NOTE: Analog modules with more than four points use different registers. See "Input Registers" on page 34 and "Holding Registers" on page 35. Also see the table showing starting registers on page 39.

Reading/Writing Analog Point Values to Input and Holding Registers (Modules with four channels or less. Only the first eight modules are shown; the rack may hold up to 16.)

SNAP 4-Channel Analog I/O			SNAP 2-Channel Analog I/O			SNAP 1-Channel Analog I/O		
Module	Point	Registers	Module	Point	Registers	Module	Point	Registers
0	0	1-2	0	0	1-2	0	0	1-2
	1	3-4		1	3-4	--	--	--
	2	5-6	--	--	--	--	--	--
	3	7-8	--	--	--	--	--	--
1	0	9-10	1	0	9-10	1	0	9-10
	1	11-12		1	11-12	--	--	--
	2	13-14	--	--	--	--	--	--
	3	15-16	--	--	--	--	--	--
2	0	17-18	2	0	17-18	2	0	17-18
	1	19-20		1	19-20	--	--	--
	2	21-22	--	--	--	--	--	--
	3	23-24	--	--	--	--	--	--
3	0	25-26	3	0	25-26	3	0	25-26
	1	27-28		1	27-28	--	--	--
	2	29-30	--	--	--	--	--	--
	3	31-32	--	--	--	--	--	--
4	0	33-34	4	0	33-34	4	0	33-34
	1	35-36		1	35-36	--	--	--
	2	37-38	--	--	--	--	--	--
	3	39-40	--	--	--	--	--	--
5	0	41-42	5	0	41-42	5	0	41-42
	1	43-44		1	43-44	--	--	--
	2	45-46	--	--	--	--	--	--
	3	47-48	--	--	--	--	--	--
6	0	49-50	6	0	49-50	6	0	49-50
	1	51-52		1	51-52	--	--	--
	2	53-54	--	--	--	--	--	--
	3	55-56	--	--	--	--	--	--
7	0	57-58	7	0	57-58	7	0	57-58
	1	59-60		1	59-60	--	--	--
	2	61-62	--	--	--	--	--	--
	3	63-64	--	--	--	--	--	--

E1 and E2 I/O Units

I/O units using a digital E1 or analog E2 brain board normally use modules containing only one point, and the maximum number of points on the rack is 16. Examples of E1 and E2 I/O units are shown below.

E1 with G4 modules

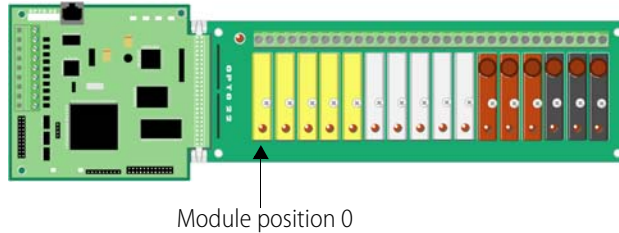

E2 with G1 modules

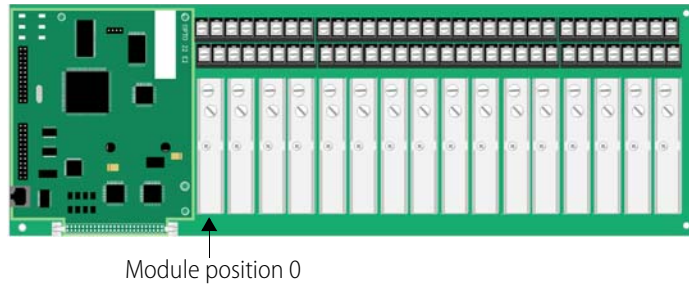

E1 with Quad Pak modules

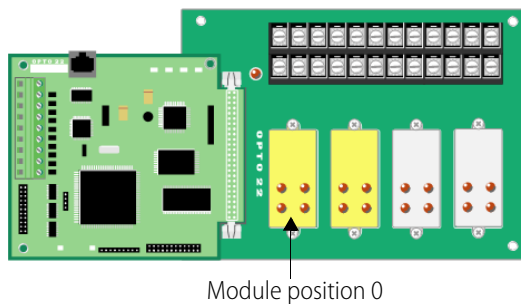

The E1 can also be used with Quad Pak modules, which have four input or four output points; but each point is treated as if it were a separate module.

The following examples illustrate how E1 and E2 module and point numbers relate to Modbus coils, inputs, and registers. For complete coil, input, and register information, see Chapter 3, “3: The Modbus Memory Map,” on [page 31](#).

E1 Example: Reading/Writing Digital Point States to Coils and Inputs

The following table shows the coils or inputs you would read or write to for point states on E1 digital modules.

E1 Digital I/O	
Module/Point	Coil or Input
0	1
1	2
2	3
3	4
4	5
5	6
6	7
7	8

E1 Digital I/O	
Module/Point	Coil or Input
8	9
9	10
10	11
11	12
12	13
13	14
14	15
15	16

E2 Example: Reading/Writing Analog Point Values to Input and Holding Registers

Point values in input and holding registers are in the form of 32-bit floats. Because Modbus registers contain only 16 bits, two consecutive registers are used to read or write the data for one point. The following table shows the input or holding registers you would use to read or write E2 analog point values.

E2 Analog I/O	
Module/Point	Input or Holding Registers
0	1-2
1	3-4
2	5-6
3	7-8
4	9-10
5	11-12
6	13-14
7	15-16

E2 Analog I/O	
Module/Point	Input or Holding Registers
8	17-18
9	19-20
10	21-22
11	23-24
12	25-26
13	27-28
14	29-30
15	31-32

G4EB2 I/O Units

These I/O units include part numbers G4EB2, G4D32EB2, and G4D32EB2-UPG. Each I/O unit has 32 total points, all of them digital. They may use G4 modules, which each have one point, or Quad Pak modules, which each have four points of the same type (all four digital inputs or all four digital outputs).

G4EB2 brains with G4 modules

Each module has just one point. You can mix input and output modules within the same group of four points.

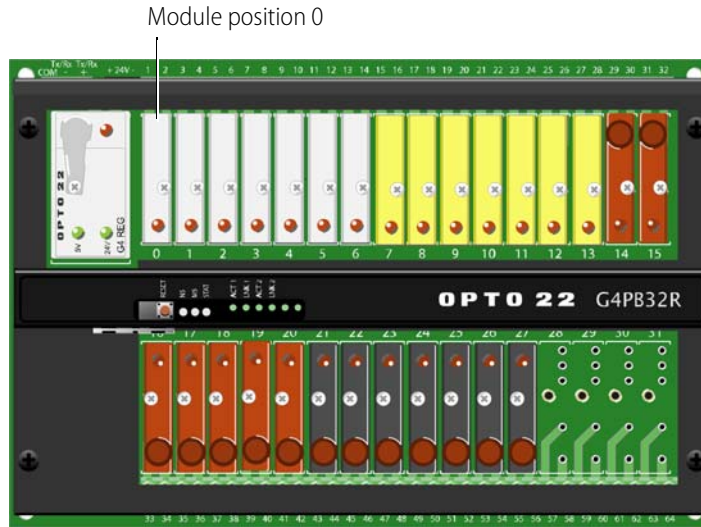

The following table shows the coils or inputs you would read or write to for point states on G4 modules.

G4 Digital I/O	
Module/Point	Coil or Input
0	1
1	2
2	3
3	4
4	5
5	6
6	7
7	8
8	9
9	10
10	11
11	12
12	13
13	14
14	15
15	16

G4 Digital I/O	
Module/Point	Coil or Input
16	17
17	18
18	19
19	20
20	21
21	22
22	23
23	24
24	25
25	26
26	27
27	28
28	29
29	30
30	31
31	32

G4EB2 brains with Quad Pak modules

Quad Pak modules have four input or four output points per module, so the four points in each group are either inputs or outputs.

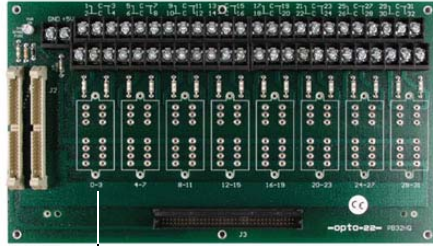

Module position 0 (points 0–3)

The following table shows the coils or inputs you would read or write to for point states on Quad Pak modules.

Quad Pak Digital I/O		
Module	Point	Coil or Input
0	0	1
	1	2
	2	3
	3	4
1	4	5
	5	6
	6	7
	7	8
2	8	9
	9	0
	0	11
	11	12
3	12	13
	13	14
	14	15
	15	16

Quad Pak Digital I/O		
Module	Point	Coil or Input
4	16	17
	17	18
	18	19
	19	20
5	20	21
	21	22
	22	23
	23	24
6	24	25
	25	26
	26	27
	27	28
7	28	29
	29	30
	30	31
	31	32

Configuring I/O Points

You need to configure points only once and then save configuration to flash memory.

CAUTION: *Store to flash only once! Storing to flash memory in a loop can wear out the memory.*

If you are using PAC Control, configure points there while you are programming your strategy. If you are not using PAC Control, configure points in PAC Manager and save to flash memory.

NOTE: You can configure E1 and E2 brain boards like any other I/O unit if you have E1/E2 firmware R1.2a (and higher) and PAC Project 9.5000 (and higher). Also, if a SNAP PAC controller communicates with the E1 or E2, the controller must have PAC firmware R9.5a (or higher) to use this simplified configuration method.

If you are not using these firmware and software versions (or if you prefer to use the previous method to reconfigure existing E1s or E2s), see Opto 22 [form 1576](#), [I/O Configuration for E1 and E2 Brain Boards](#).

Configuring I/O Points for SNAP Analog/Digital I/O Units

IMPORTANT: *If you are using PAC Control or PAC Manager, do not use this section. Configure points within PAC Control or PAC Manager. Use this section to configure I/O points only if Modbus/TCP will be the only communication to the I/O unit.*

(For SNAP digital-only I/O units, see [page 25](#).) All SNAP analog/digital I/O units recognize analog, serial, and high-density digital modules on the rack. Positions on the rack that don't contain modules the I/O unit recognizes are assumed to contain digital input modules. If the individual point types on the module differ from the default type for that module, you must configure the points using the tables below.

SNAP I/O Point Types

The following tables show SNAP I/O modules that can be used with Ethernet-based I/O units and Modbus/TCP (some older I/O units cannot use all of these modules; see the module's data sheet for compatibility). Default point types are shaded. If a point differs from the default, use the value in the Point Type (Hex) column to configure the point. For examples of point configuration, see [page 24](#), following the tables.

Digital Inputs and Outputs

Module & Description	Point Type (Dec)	Point Type (Hex)	Module Type (Hex)
4-channel digital input module*	256	100	00
4-channel digital output module*	384	180	00

* High-density digital modules are automatically recognized; points do not require configuration.

Analog Inputs

Part Number & Description	Point Type (Dec)	Point Type (Hex)	Module Type (Hex)	Points per Module	Default Unit of Measurement	Underrange	Low Scale	Full Scale	Overrange
SNAP-AIARMS: 0 - 10 A AC/DC	71	47	71	2	A	0.0	0.0	10.0	11.0
SNAP-AIARMS-i: 0 - 10 A AC/DC	71	47	29	2	A	0.0	0.0	10.0	11.0
SNAP-AIARMS-i-FM: 0 - 10 A AC/DC	71	47	29	2	A	0.0	0.0	10.0	11.0
SNAP-AICTD: ICTD Temp. Probe	4	4	04	2	Degrees C	-273.0	-40.0	150.0	150.0
SNAP-AICTD-4: ICTD Temp. Probe	4	4	42	4	Degrees C	-273.0	-40.0	150.0	150.0
SNAP-AICTD-8: ICTD Temp. Probe	4	4	4C	8	Degrees C	-273.0	-40.0	150.0	150.0
SNAP-AILC: -2 - +2 mV/V Fast	34	22	0B	2	Percent	-110.0	-100.0	100.0	110.0
SNAP-AILC: -2 - +2 mV/V Slow	36	24	0B	2	Percent	-110.0	-100.0	100.0	110.0
SNAP-AILC: -3 - +3 mV/V Fast	35	23	0B	2	Percent	-110.0	-100.0	100.0	110.0
SNAP-AILC: -3 - +3 mV/V Slow	37	25	0B	2	Percent	-110.0	-100.0	100.0	110.0
SNAP-AILC: Filter of 1st channel	0	0	0B	2	Percent	-110.0	-100.0	100.0	110.0
SNAP-AILC-2: -3 - +3 mV/V Fast	35	23	0C	2	Percent	-110.0	-100.0	100.0	110.0
SNAP-AILC-2: -3 - +3 mV/V Slow	37	25	0C	2	Percent	-110.0	-100.0	100.0	110.0
SNAP-AILC-2: -4 - +4 mV/V Fast	34	22	0C	2	Percent	-110.0	-100.0	100.0	110.0
SNAP-AILC-2: -4 - +4 mV/V Slow	36	24	0C	2	Percent	-110.0	-100.0	100.0	110.0
SNAP-AILC-2: Filter of 1st channel	0	0	0C	2	Percent	-110.0	-100.0	100.0	110.0
SNAP-AIMA: -20 - +20 mA	64	40	64	2	mA	-22.0	-20.0	20.0	22.0
SNAP-AIMA: 0 - +20 mA	2	2	64	2	mA	-22.0	0.0	20.0	22.0
SNAP-AIMA: 4 - +20 mA	3	3	64	2	mA	-22.0	4.0	20.0	22.0
SNAP-AIMA2-i: -1 to +1 mA	85	55	27	2	mA	-1.1	-1.0	1.0	1.1
SNAP-AIMA-i: -20 - +20 mA	64	40	22	2	mA	-22.0	-20.0	20.0	22.0
SNAP-AIMA-i: 0 - +20 mA	2	2	22	2	mA	-22.0	0.0	20.0	22.0
SNAP-AIMA-i: 4 - +20 mA	3	3	22	2	mA	-22.0	4.0	20.0	22.0
SNAP-AIMA-iH: 4 - +20 mA	3	3	2A	2	mA	3.2	4.0	20.0	24.0
SNAP-AIMA-iSRC: -20 - +20 mA	64	40	26	2	mA	-22.0	-20.0	20.0	22.0
SNAP-AIMA-iSRC: 0 - +20 mA	2	2	26	2	mA	-22.0	0.0	20.0	22.0
SNAP-AIMA-iSRC: 4 - +20 mA	3	3	26	2	mA	-22.0	4.0	20.0	22.0
SNAP-AIMA-iSRC-FM: -20 - +20 mA	64	40	26	2	mA	-22.0	-20.0	20.0	22.0
SNAP-AIMA-iSRC-FM: 0 - +20 mA	2	2	26	2	mA	-22.0	0.0	20.0	22.0
SNAP-AIMA-iSRC-FM: 4 - +20 mA	3	3	26	2	mA	-22.0	4.0	20.0	22.0
SNAP-AIMA-4: -20 - +20 mA	64	40	40	4	mA	-22.0	-20.0	20.0	22.0
SNAP-AIMA-4: 0 - +20 mA	2	2	40	4	mA	-22.0	0.0	20.0	22.0
SNAP-AIMA-4: 4 - +20 mA	3	3	40	4	mA	-22.0	4.0	20.0	22.0
SNAP-AIMA-8: -20 - +20 mA	64	40	4A	8	mA	-22.0	-20.0	20.0	22.0
SNAP-AIMA-8: 0 - +20 mA	2	2	4A	8	mA	-22.0	0.0	20.0	22.0
SNAP-AIMA-8: 4 - +20 mA	3	3	4A	8	mA	-22.0	4.0	20.0	22.0

Part Number & Description	Point Type (Dec)	Point Type (Hex)	Module Type (Hex)	Points per Module	Default Unit of Measurement	Underrange	Low Scale	Full Scale	Overrange
SNAP-AIMA-32: -20 to +20 mA	64	40	4D	32	mA	-22.0	-20.0	20.0	22.0
SNAP-AIMA-32: 0 - +20 mA	2	2	4D	32	mA	-22.0	0.0	20.0	22.0
SNAP-AIMA-32: 4 - +20 mA	3	3	4D	32	mA	-22.0	4.0	20.0	22.0
SNAP-AIMA-32-FM: -20 to +20 mA	64	40	4D	32	mA	-22.0	-20.0	20.0	22.0
SNAP-AIMA-32-FM: 0 - +20 mA	2	2	4D	32	mA	-22.0	0.0	20.0	22.0
SNAP-AIMA-32-FM: 4 - +20 mA	3	3	4D	32	mA	-22.0	4.0	20.0	22.0
SNAP-AIMV-4: -150 - +150 mV	66	42	44	4	mV	-165.0	-150.0	150.0	165.0
SNAP-AIMV-4: -75 - +75 mV	68	44	44	4	mV	-82.5	-75.0	75.0	82.5
SNAP-AIMV2-4: -50 - +50 mV	9	9	45	4	mV	-55.0	-50.0	50.0	55.0
SNAP-AIMV2-4: -25 - +25 mV	67	43	45	4	mV	-27.5	-25.0	25.0	27.5
SNAP-AIPM (point 0 only)	70	46	0A	*	AC VRMS	0.0	0	250	275
SNAP-AIPM (point 1 only)	71	47	0A	*	AC ARMS	0.0	0	10	11.0
SNAP-AIPM (point 2 only)	82	52	0A	*	True power	n/a	n/a	n/a	n/a
SNAP-AIPM (point 3 only)	83	53	0A	*	Volt/Amps	n/a	n/a	n/a	n/a
SNAP-AIPM-3 (points 0, 4, & 8)	70	46	49	*	AC VRMS	0.0	0	300	330
SNAP-AIPM-3 (points 1, 5, & 9)	71	47	49	*	AC ARMS	0.0	0	5	5.5
SNAP-AIPM-3 (points 2, 6, & 10)	82	52	49	*	True power	n/a	n/a	n/a	n/a
SNAP-AIPM-3 (points 3, 7, & 11)	83	53	49	*	Volt/Amps	n/a	n/a	n/a	n/a
SNAP-AIPM-3 (points 12 & 13)	86	56	49	*	True power	n/a	n/a	n/a	n/a
SNAP-AIPM-3V (points 0, 4, & 8)	100	64	48	*	AC VRMS	0.0	0	300	330
SNAP-AIPM-3V (points 1, 5, & 9)	89	59	48	*	VAC from CT	0.0	0	0.333	0.366
SNAP-AIPM-3V (points 2, 6, & 10)	90	5A	48	*	True power	n/a	n/a	n/a	n/a
SNAP-AIPM-3V (points 3, 7, & 11)	90	5A	48	*	Volt/Amps	n/a	n/a	n/a	n/a
SNAP-AIPM-3V (points 12 & 13)	184	B8	48	*	True power	n/a	n/a	n/a	n/a
SNAP-AIRATE: Rate (Frequency)	69	45	69	2	Hz	0.0	0.0	25000.0	27500.0
SNAP-AIRATE-HFi: Rate (0.1 s data freshness)	68	44	2B	2	Hz	2	2	500,000	500,000
SNAP-AIRATE-HFi: Rate (1 s data freshness)	69	45	2B	2	Hz	20	20	500,000	500,000
SNAP-AIRTD: 100 Ohm Pt 3-wire	10	0A	10	2	Degrees C	-200.0	-200.0	850.0	850.0
SNAP-AIRTD: 100 Ohm Ni 3-wire	46	2E	10	2	Degrees C	-60.0	-60.0	250.0	250.0
SNAP-AIRTD: 0 - 400 Ohms, Lead Compensated	15	0F	10	2	Ohms	0	0	400	440
SNAP-AIRTD: 120 Ohm Ni 3-wire	48	30	10	2	Degrees C	-80.0	-80.0	260.0	260.0
SNAP-AIRTD-10: 10 Ohm Cu 3-wire	14	0E	0E	2	Degrees C	-180.0	-180.0	260.0	260.0
SNAP-AIRTD-10: 0 - 25 Ohms, Lead Compensated	15	0F	0E	2	Ohms	0	0	25	27.5
SNAP-AIRTD-1K: 1000 Ohm Pt 3-wire	92	5C	0F	2	Degrees C	-200.0	-200.0	850.0	850.0

Part Number & Description	Point Type (Dec)	Point Type (Hex)	Module Type (Hex)	Points per Module	Default Unit of Measurement	Underrange	Low Scale	Full Scale	Overrange
SNAP-AIRTD-1K: 1000 Ohm Ni 3-wire	93	5D	0F	2	Degrees C	-60.0	-60.0	250.0	250.0
SNAP-AIRTD-1K: 1000 Ohm Ni 3-wire	94	5E	0F	2	Degrees F	-50.0	-50.0	275.0	275.0
SNAP-AIRTD-1K: 0 - 4000 Ohms, Lead Compensated	15	0F	0F	2	Ohms	0	0	4000	4400
SNAP-AIRTD-8U: 0-8000 Ohms - Fixed	155	9B	55	8	Ohms	0	0	8000	8800
SNAP-AIRTD-8U: 1000 Ohm Ni 3-wire @ 70° F	182	B6	55	8	Degrees F	-46	-46	148.9	148.9
SNAP-AIRTD-8U: 1000 Ohm Ni 3-wire @ 0 °C	181	B5	55	8	Degrees C	-40	-40	135	135
SNAP-AIRTD-8U: 1000 Ohm Pt @ 0 °C	180	B4	55	8	Degrees C	-200	-200	850	850
SNAP-AIRTD-8U: 120 Ohm Ni @ 0 °C	179	B3	55	8	Degrees C	-80	-80	260	260
SNAP-AIRTD-8U: 100 Ohm Ni @ 0 °C	178	B2	55	8	Degrees C	-60	-60	250	250
SNAP-AIRTD-8U: 100 Ohm Pt @ 0 °C	177	B1	55	8	Degrees C	-200	-200	850	850
SNAP-AIRTD-8U: 10 Ohm Cu	176	B0	55	8	Degrees C	-60	-60	355	355
SNAP-AIRTD-8U: 0-8000 Ohms - Auto	171	AB	55	8	Ohms	0	0	8000	8800
SNAP-AIRTD-8U: 0-4000 Ohms - Auto	170	AA	55	8	Ohms	0	0	4000	4400
SNAP-AIRTD-8U: 0-2000 Ohms - Auto	169	A9	55	8	Ohms	0	0	2000	2200
SNAP-AIRTD-8U: 0-1000 Ohms - Auto	168	A8	55	8	Ohms	0	0	1000	1100
SNAP-AIRTD-8U: 0-800 Ohms - Auto	167	A7	55	8	Ohms	0	0	800	880
SNAP-AIRTD-8U: 0-400 Ohms - Auto	166	A6	55	8	Ohms	0	0	400	440
SNAP-AIRTD-8U: 0-200 Ohms - Auto	165	A5	55	8	Ohms	0	0	200	220
SNAP-AIRTD-8U: 0-100 Ohms - Auto	164	A4	55	8	Ohms	0	0	100	110
SNAP-AIRTD-8U: 0-80 Ohms - Auto	163	A3	55	8	Ohms	0	0	80	88
SNAP-AIRTD-8U: 0-40 Ohms - Auto	162	A2	55	8	Ohms	0	0	40	44
SNAP-AIRTD-8U: 0-20 Ohms - Auto	161	A1	55	8	Ohms	0	0	20	22
SNAP-AIRTD-8U: 0-10 Ohms - Auto	160	A0	55	8	Ohms	0	0	10	11
SNAP-AIRTD-8U: 0-4000 Ohms - Fixed	154	9A	55	8	Ohms	0	0	4000	4400
SNAP-AIRTD-8U: 0-2000 Ohms - Fixed	153	99	55	8	Ohms	0	0	2000	2200
SNAP-AIRTD-8U: 0-1000 Ohms - Fixed	152	98	55	8	Ohms	0	0	1000	1100
SNAP-AIRTD-8U: 0-800 Ohms - Fixed	151	97	55	8	Ohms	0	0	800	880
SNAP-AIRTD-8U: 0-400 Ohms - Fixed	150	96	55	8	Ohms	0	0	400	440
SNAP-AIRTD-8U: 0-200 Ohms - Fixed	149	95	55	8	Ohms	0	0	200	220
SNAP-AIRTD-8U: 0-100 Ohms - Fixed	148	94	55	8	Ohms	0	0	100	110
SNAP-AIRTD-8U: 0-80 Ohms - Fixed	147	93	55	8	Ohms	0	0	80	88
SNAP-AIRTD-8U: 0-40 Ohms - Fixed	146	92	55	8	Ohms	0	0	40	44
SNAP-AIRTD-8U: 0-20 Ohms - Fixed	145	91	55	8	Ohms	0	0	20	22
SNAP-AIRTD-8U: 0-10 Ohms - Fixed	144	90	55	8	Ohms	0	0	10	11

Part Number & Description	Point Type (Dec)	Point Type (Hex)	Module Type (Hex)	Points per Module	Default Unit of Measurement	Underrange	Low Scale	Full Scale	Overrange
SNAP-AITM : -150 - +150 mV	66	42	66	2	mV	-165.0	-150.0	150.0	165.0
SNAP-AITM: -75 - +75 mV	68	44	66	2	mV	-82.5	-75.0	75.0	82.5
SNAP-AITM: Type E Thermocouple	19	13	66	2	Degrees C	-270.0	-270.0	1000.0	1000.0
SNAP-AITM: Type J Thermocouple	5	5	66	2	Degrees C	-210.0	-210.0	1200.0	1200.0
SNAP-AITM: Type K Thermocouple	8	8	66	2	Degrees C	-270.0	-270.0	1372.0	1372.0
SNAP-AITM-i : -150 - +150 mV	66	42	20	2	mV	-165.0	-150.0	150.0	165.0
SNAP-AITM-i: -75 - +75 mV	68	44	20	2	mV	-82.5	-75.0	75.0	82.5
SNAP-AITM-i: Type E Thermocouple	19	13	20	2	Degrees C	-270.0	-270.0	1000.0	1000.0
SNAP-AITM-i: Type J Thermocouple	5	5	20	2	Degrees C	-210.0	-210.0	1200.0	1200.0
SNAP-AITM-i: Type K Thermocouple	8	8	20	2	Degrees C	-270.0	-270.0	1372.0	1372.0
SNAP-AITM-4i : -150 - +150 mV	66	42	32	4	mV	-165.0	-150.0	150.0	165.0
SNAP-AITM-4i: -75 - +75 mV	68	44	32	4	mV	-82.5	-75.0	75	82.5
SNAP-AITM-4i: -50 - +50 mV	9	9	32	4	mV	-55.0	-50.0	50.0	55.0
SNAP-AITM-4i: -25 - +25 mV	67	43	32	4	mV	-27.5	-25.0	25.0	27.5
SNAP-AITM-4i: Type B Thermocouple	24	18	32	4	Degrees C	42.0	42.0	1820.0	1820.0
SNAP-AITM-4i: Type C Thermocouple	32	20	32	4	Degrees C	0.0	0.0	2320.0	2320.0
SNAP-AITM-4i: Type D Thermocouple	33	21	32	4	Degrees C	0.0	0.0	2320.0	2320.0
SNAP-AITM-4i: Type E Thermocouple	19	13	32	4	Degrees C	-270.0	-270.0	1000.0	1000.0
SNAP-AITM-4i: Type G Thermocouple	31	1F	32	4	Degrees C	0.0	0.0	2320.0	2320.0
SNAP-AITM-4i: Type J Thermocouple	5	5	32	4	Degrees C	-210.0	-210.0	1200.0	1200.0
SNAP-AITM-4i: Type K Thermocouple	8	8	32	4	Degrees C	-270.0	-270.0	1372.0	1372.0
SNAP-AITM-4i: Type N Thermocouple	30	1E	32	4	Degrees C	-270.0	-270.0	1300.0	1300.0
SNAP-AITM-4i: Type R Thermocouple	17	11	32	4	Degrees C	-50.0	-50.0	1768.0	1768.0
SNAP-AITM-4i: Type S Thermocouple	23	17	32	4	Degrees C	-50.0	-50.0	1768.0	1768.0
SNAP-AITM-4i: Type T Thermocouple	18	12	32	4	Degrees C	-270.0	-270.0	400.0	400.0
SNAP-AITM-8 : -75 - +75 mV	68	44	4F	8	mV	-82.5	-75.0	75.0	82.5
SNAP-AITM-8: -50 - +50 mV	9	9	4F	8	mV	-55.0	-50.0	50.0	55.0
SNAP-AITM-8: -25 - +25 mV	67	43	4F	8	mV	-27.5	-25.0	25.0	27.5
SNAP-AITM-8: Type B Thermocouple	24	18	4F	8	Degrees C	42.0	42.0	1820.0	1820.0
SNAP-AITM-8: Type C Thermocouple	32	20	4F	8	Degrees C	0.0	0.0	2320.0	2320.0
SNAP-AITM-8: Type D Thermocouple	33	21	4F	8	Degrees C	0.0	0.0	2320.0	2320.0
SNAP-AITM-8: Type E Thermocouple	19	13	4F	8	Degrees C	-270.0	-270.0	1000.0	1000.0
SNAP-AITM-8: Type G Thermocouple	31	1F	4F	8	Degrees C	0.0	0.0	2320.0	2320.0
SNAP-AITM-8: Type J Thermocouple	5	5	4F	8	Degrees C	-210.0	-210.0	1200.0	1200.0
SNAP-AITM-8: Type K Thermocouple	8	8	4F	8	Degrees C	-270.0	-270.0	1372.0	1372.0
SNAP-AITM-8: Type N Thermocouple	30	1E	4F	8	Degrees C	-270.0	-270.0	1300.0	1300.0
SNAP-AITM-8: Type R Thermocouple	17	11	4F	8	Degrees C	-50.0	-50.0	1768.0	1768.0
SNAP-AITM-8: Type S Thermocouple	23	17	4F	8	Degrees C	-50.0	-50.0	1768.0	1768.0

Part Number & Description	Point Type (Dec)	Point Type (Hex)	Module Type (Hex)	Points per Module	Default Unit of Measurement	Underrange	Low Scale	Full Scale	Overrange
SNAP-AITM-8: Type T Thermocouple	18	12	4F	8	Degrees C	-270.0	-270.0	400.0	400.0
SNAP-AITM-8-FM: -75 - +75 mV	68	44	4F	8	mV	-82.5	-75.0	75.0	82.5
SNAP-AITM-8-FM: -50 - +50 mV	9	9	4F	8	mV	-55.0	-50.0	50.0	55.0
SNAP-AITM-8-FM: -25 - +25 mV	67	43	4F	8	mV	-27.5	-25.0	25.0	27.5
SNAP-AITM-8-FM: Type B Thermocple	24	18	4F	8	Degrees C	42.0	42.0	1820.0	1820.0
SNAP-AITM-8-FM: Type C Thermocple	32	20	4F	8	Degrees C	0.0	0.0	2320.0	2320.0
SNAP-AITM-8-FM: Type D Thermocple	33	21	4F	8	Degrees C	0.0	0.0	2320.0	2320.0
SNAP-AITM-8-FM: Type E Thermocple	19	13	4F	8	Degrees C	-270.0	-270.0	1000.0	1000.0
SNAP-AITM-8-FM: Type G Thermocple	31	1F	4F	8	Degrees C	0.0	0.0	2320.0	2320.0
SNAP-AITM-8-FM: Type J Thermocple	5	5	4F	8	Degrees C	-210.0	-210.0	1200.0	1200.0
SNAP-AITM-8-FM: Type K Thermocple	8	8	4F	8	Degrees C	-270.0	-270.0	1372.0	1372.0
SNAP-AITM-8-FM: Type N Thermocple	30	1E	4F	8	Degrees C	-270.0	-270.0	1300.0	1300.0
SNAP-AITM-8-FM: Type R Thermocple	17	11	4F	8	Degrees C	-50.0	-50.0	1768.0	1768.0
SNAP-AITM-8-FM: Type S Thermocple	23	17	4F	8	Degrees C	-50.0	-50.0	1768.0	1768.0
SNAP-AITM-8-FM: Type T Thermocple	18	12	4F	8	Degrees C	-270.0	-270.0	400.0	400.0
SNAP-AITM2: -50 - +50 mV	9	9	09	2	mV	-55.0	-50.0	50.0	55.0
SNAP-AITM2: -25 - +25 mV	67	43	09	2	mV	-27.5	-25.0	25.0	27.5
SNAP-AITM2: Type B Thermocouple	24	18	09	2	Degrees C	42.0	42.0	1820.0	1820.0
SNAP-AITM2: Type C Thermocouple	32	20	09	2	Degrees C	0.0	0.0	2320.0	2320.0
SNAP-AITM2: Type D Thermocouple	33	21	09	2	Degrees C	0.0	0.0	2320.0	2320.0
SNAP-AITM2: Type G Thermocouple	31	1F	09	2	Degrees C	0.0	0.0	2320.0	2320.0
SNAP-AITM2: Type N Thermocouple	30	1E	09	2	Degrees C	-270.0	-270.0	1300.0	1300.0
SNAP-AITM2: Type R Thermocouple	17	11	09	2	Degrees C	-50.0	-50.0	1768.0	1768.0
SNAP-AITM2: Type S Thermocouple	23	17	09	2	Degrees C	-50.0	-50.0	1768.0	1768.0
SNAP-AITM2: Type T Thermocouple	18	12	09	2	Degrees C	-270.0	-270.0	400.0	400.0
SNAP-AITM2-i: -50 - +50 mV	9	9	21	2	mV	-55.0	-50.0	50.0	55.0
SNAP-AITM2-i: -25 - +25 mV	67	43	21	2	mV	-27.5	-25.0	25.0	27.5
SNAP-AITM2-i: Type B Thermocouple	24	18	21	2	Degrees C	42.0	42.0	1820.0	1820.0
SNAP-AITM2-i: Type C Thermocouple	32	20	21	2	Degrees C	0.0	0.0	2320.0	2320.0
SNAP-AITM2-i: Type D Thermocouple	33	21	21	2	Degrees C	0.0	0.0	2320.0	2320.0
SNAP-AITM2-i: Type G Thermocouple	31	1F	21	2	Degrees C	0.0	0.0	2320.0	2320.0
SNAP-AITM2-i: Type N Thermocouple	30	1E	21	2	Degrees C	-270.0	-270.0	1300.0	1300.0
SNAP-AITM2-i: Type R Thermocouple	17	11	21	2	Degrees C	-50.0	-50.0	1768.0	1768.0
SNAP-AITM2-i: Type S Thermocouple	23	17	21	2	Degrees C	-50.0	-50.0	1768.0	1768.0
SNAP-AITM2-i: Type T Thermocouple	18	12	21	2	Degrees C	-270.0	-270.0	400.0	400.0
SNAP-AIV: -10 - +10 VDC	12	C	12	2	VDC	-11.0	-10.0	10.0	11.0
SNAP-AIV: -5 - +5 VDC	11	B	12	2	VDC	-5.5	-5.0	5.0	5.5

Part Number & Description	Point Type (Dec)	Point Type (Hex)	Module Type (Hex)	Points per Module	Default Unit of Measurement	Underrange	Low Scale	Full Scale	Overrange
SNAP-AIV-i : -10 - +10 VDC	12	C	23	2	VDC	-11.0	-10.0	10.0	11.0
SNAP-AIV-i: -5 - +5 VDC	11	B	23	2	VDC	-5.5	-5.0	5.0	5.5
SNAP-AIV-4 : -10 - +10 VDC	12	C	41	4	VDC	-11.0	-10.0	10.0	11.0
SNAP-AIV-4: -5 - +5 VDC	11	B	41	4	VDC	-5.5	-5.0	5.0	5.5
SNAP-AIV-8 : -10 - +10 VDC	12	C	4B	8	VDC	-11.0	-10.0	10.0	11.0
SNAP-AIV-8: -5 - +5 VDC	11	B	4B	8	VDC	-5.5	-5.0	5.0	5.5
SNAP-AIV-32 : -10 - +10 VDC	12	C	4E	32	VDC	-11.0	-10.0	10.0	11.0
SNAP-AIV-32: -5 - +5 VDC	11	B	4E	32	VDC	-5.5	-5.0	5.0	5.5
SNAP-AIV-32-FM : -10 - +10 VDC	12	C	4E	32	VDC	-11.0	-10.0	10.0	11.0
SNAP-AIV-32-FM: -5 - +5 VDC	11	B	4E	32	VDC	-5.5	-5.0	5.0	5.5
SNAP-AIV2-i : -100 - +100 VDC	72	48	24	2	VDC	-110.0	-100.0	100.0	110.0
SNAP-AIV2-i: -50 - +50 VDC	73	49	24	2	VDC	-55.0	-50.0	50.0	55.0
SNAP-AIVRMS : 0 - 250 VAC/VDC	70	46	70	2	VAC/VDC	0.0	0.0	250.0	275.0
SNAP-AIVRMS-i : 0 - 250 VAC/VDC	70	46	28	2	VAC/VDC	0.0	0.0	250.0	275.0
SNAP-AIVRMS-i-FM : 0-250 VAC/VDC	70	46	28	2	VAC/VDC	0.0	0.0	250.0	275.0
SNAP-AIR40K-4 : 0 to 40K Ohms	74	4A	43	4	Ohms	0	0	40,000	44,000
SNAP-AIR40K-4: 0 to 20K Ohms	75	4B	43	4	Ohms	0	0	20,000	22,000
SNAP-AIR40K-4: 0 to 10K Ohms	76	4C	43	4	Ohms	0	0	10,000	11,000
SNAP-AIR40K-4: 0 to 5K Ohms	77	4D	43	4	Ohms	0	0	5000	5500
SNAP-AIR400K-8 : 0 to 400K Ohms	105	69	54	8	Ohms	0	0	400,000	440,000
SNAP-AIR400K-8: 0 to 400K Autorange	188	BC	54	8	Ohms	0	0	400,000	440,000
SNAP-AIR400K-8: 0 to 200K Ohms	106	6A	54	8	Ohms	0	0	200,000	220,000
SNAP-AIR400K-8: 0 to 100K Ohms	107	6B	54	8	Ohms	0	0	100,000	110,000
SNAP-AIR400K-8: 0 to 50K Ohms	108	6C	54	8	Ohms	0	0	50,000	55,000
SNAP-AIR400K-8: 0 to 40K Ohms	74	4A	54	8	Ohms	0	0	40,000	44,000
SNAP-AIR400K-8: 0 to 20K Ohms	75	4B	54	8	Ohms	0	0	20,000	22,000
SNAP-AIR400K-8: 0 to 10K Ohms	76	4C	54	8	Ohms	0	0	10,000	11,000
SNAP-AIR400K-8: 0 to 5K Ohms	77	4D	54	8	Ohms	0	0	5000	5500
SNAP-AIR400K-8: 0 to 4K Ohms	38	26	54	8	Ohms	0	0	4000	4400
SNAP-AIR400K-8: 0 to 2K Ohms	39	27	54	8	Ohms	0	0	2000	2200
SNAP-AIR400K-8: 0 to 1K Ohms	40	28	54	8	Ohms	0	0	1000	1100
SNAP-AIR400K-8: 0 to 500 Ohms	41	29	54	8	Ohms	0	0	500	550
SNAP-pH/ORP : -1 - +1 VDC	78	4E	25	2	VDC	-1.1	-1.0	1.0	1.1
SNAP-pH/ORP: 0 - 14 pH	79	4F	25	2	pH	-1.4	0.0	14.0	15.4
SNAP-pH/ORP: -0.5 - +0.5 VDC	80	50	25	2	VDC	-0.55	-0.5	0.5	0.55
SNAP-PID-V	99	63	D0	4	Percent	0	0	100.0	110.0

* The SNAP-AIPM module monitors one device from point 0 (volts) and point 1 (amps). Points 2 and 3 return calculated values. The SNAP-AIPM-3 and SNAP-AIPM-3V monitor three phases from points 0,4, & 8 (volts) and points 1,5, & 9 (amps). All other points return calculated values. See Opto 22 form 1453, the [SNAP AIPM Modules Data Sheet](#), for details.

Analog Outputs

Part Number & Description	Point Type (Dec)	Point Type (Hex)	Module Type (Hex)	Points per Module	Default Unit of Measurement	Underrange	Low scale	Full scale	Overrange
SNAP-AOA-3: 4 - 20 mA	131	83	83	1	mA	4.0	4.0	20.0	20.0
SNAP-AOV-5: 0 - 10 VDC	133	85	85	1	VDC	0.0	0.0	10.0	10.0
SNAP-AOA-23: 4 - 20 mA	163	A3	A3	2	mA	4.0	4.0	20.0	20.0
SNAP-AOA-23-iSRC: 4 - 20 mA	163	A3	B3	2	mA	4.0	4.0	20.0	20.0
SNAP-AOA-23-iSRC-FM: 4 - 20 mA	163	A3	B3	2	mA	4.0	4.0	20.0	20.0
SNAP-AOA-23-iH: 4 - 20 mA	163	A3	AB	2	mA	4.0	4.0	20.0	20.0
SNAP-AOV-25: 0 - 10 VDC	165	A5	A5	2	VDC	0.0	0.0	10.0	10.0
SNAP-AOV-27: -10 - +10 VDC	167	A7	A7	2	VDC	-10.0	-10.0	10.0	10.0
SNAP-AOA-28: 0 - 20 mA	168	A8	A8	2	mA	0.0	0.0	20.0	20.0
SNAP-AOVA-8: 0 - 5 VDC	144	90	CF	8	VDC	0.0	0.0	5.0	5.0
SNAP-AOVA-8: 0 - 10 VDC	145	91	CF	8	VDC	0.0	0.0	10.0	10.0
SNAP-AOVA-8: -5 to +5 VDC	146	92	CF	8	VDC	-5.0	-5.0	5.0	5.0
SNAP-AOVA-8: -10 to +10 VDC	147	93	CF	8	VDC	-10.0	-10.0	10.0	10.0
SNAP-AOVA-8: 4 - 20 mA	148	94	CF	8	mA	4.0	4.0	20.0	20.0
SNAP-AOVA-8: 0 - 20 mA	149	95	CF	8	mA	0.0	0.0	20.0	20.0
SNAP-AOD-29: TPO 5 - 60 VDC	169	A9	A9	2	percent	n/a	0.0	100.0	n/a
SNAP-AOD-29-HFi: TPO 2.5-24 VDC	131	83	B9	2	percent	n/a	0.0	100.0	n/a

Examples of Configured SNAP I/O Points for Modbus

To configure I/O points for Modbus/TCP, write the point configuration data from the previous table to holding registers 11271–13318. Since the data for this area of the Modbus map is in the form of 32-bit integers, use two consecutive registers to write the data to one point.

For example, look at the tables starting on [page 17](#). If the module in position 0 on the rack is a SNAP-AIV with a -5 to +5 V input, it is not the default for that module. Therefore you must configure its points. Now take a look at the Holding Registers section of the Modbus map on [page 35](#). You will write to the Configure Points area, registers 11271–13318. Since it takes two registers per point and the analog module has two points, you write the hex value 0B (for a -5 to +5 V analog input) to the first four registers, 11271–11274.

As another example, suppose the module in position 1 on the rack is a 4-channel digital output module. Since the default is a 4-channel digital *input* module, you must configure its points. You write the hex value 180 (for a 4-channel digital output module) to the registers for module 1.

Configuring I/O Points for SNAP Digital-Only I/O Units

The digital-only SNAP-UP1-D64 and SNAP-ENET-D64 I/O units assume that all positions on the rack contain 4-channel digital input modules. If a position contains an output module, you must configure its points as outputs.

For example, suppose the module in position 0 on the rack is a 4-channel digital output module. To configure its points, write a 1 to coils 193–196. See the Modbus memory map on [page 32](#). (Be sure you are looking in the column for these digital-only I/O units.)

NOTE: SNAP digital-only I/O units support 4-channel digital modules only; they do not support high-density digital modules.

Using I/O Point Features

The I/O point features available on Opto 22 I/O units used with Modbus/TCP depend on the combined capabilities of the I/O processor and the module. Note that some features available through other communication methods (PAC Control, Optomux, or OptoMMP, depending on the processor) are not available in the Modbus memory map.

The following features are discussed in this chapter. See the referenced pages for more information on using them in your application.

Feature	Description	See	
		For SNAP	For E1/E2
Point States	(digital inputs and outputs)—A digital point is either on or off. You can read the current state of a digital input or write an on/off state to a digital output.	page 10	page 14
Point Values	(analog inputs and outputs)—An analog point has a range of values. You can read the current value of an analog input or write a value to an analog output.	page 11	page 14
Latches	(digital inputs)—When the value of a digital input point changes from off to on, an on-latch is automatically set. While the value of the point may return to off, the on-latch remains set, as a record of the change, until you clear it. Similarly, an off-latch is set when the value of a digital point changes from on to off, and it remains set until cleared.	page 26	page 27
Counters	(digital inputs)—A counter keeps track of the number of times a digital input changes from off to on. The count accumulates until it reaches the maximum count available in the I/O unit or until you reset the counter to zero. For example, to count the number of widgets produced per shift, you would clear the counter at the start of each shift and read it at the end of each shift. The speed of the counter depends upon the I/O processor's capabilities and the speed of the module used.	page 26	page 28
Scaling	(analog points)—Analog input and output points can be scaled as needed. For example, you can scale a -5 V to +5 V input point to reflect 0% to 100%	page 27	page 28
Minimum & maximum values	(analog inputs)—Minimum and maximum values are sometimes called peaks and valleys. You can read these values at any time, for example, to record minimum and maximum temperatures. You can also reset min/max values. For example, if you want to record the maximum temperature at point 2 in each 24-hour period, you must reset the values after they are read each day.	page 27	page 28

Feature	Description	See	
		For SNAP	For E1/E2
Offset and gain	(analog inputs) Offset and gain calculations are used to calibrate analog points. If a -50 mV to +50 mV input receives signals that are slightly off (not exactly -50 mV at the lowest point, for example), the offset and gain can be calculated so that values will appear accurately when read.	page 27	page 29

SNAP Digital I/O Point Features

Refer to the “3: The Modbus Memory Map” on page 31 to find the coils, inputs, and registers mentioned in this section. For explanations of point features, see [page 25](#).

Latches

Latches are a point feature automatically available on SNAP Ethernet-based I/O units; they do not require configuration. To use latches, see the Modbus memory maps beginning on [page 31](#).

Counters

High-Speed Counters. Analog/digital I/O units with high-speed capability (such as SNAP-PAC-R1 and SNAP-PAC-EB1 I/O units) support high-speed counters on any 4-channel digital input; the actual counter speed depends on the module. Digital-only and analog/simple digital I/O units (such as SNAP-PAC-R2 and SNAP-PAC-EB2 I/O units) do not support high-speed counters. High-speed counters require configuration. See below, “Using Counters.”

Other Counters. Points on high-density digital modules automatically provide counting. These counters are not high speed; see the module’s data sheet for specific information.

Using Counters. High-speed counters involve two steps: configure the counter and read data. Counters on high-density digital modules do not need configuration for Modbus/TCP.

- To configure a *high-speed counter*, write to holding registers 13319–15366. Remember that you use two consecutive registers for each point, since the data is in the form of a 32-bit integer. For example, to configure module 0, point 0 as a counter, you would write the following:

To these registers:	13319	13320
Write this:	0	1

- To read high-speed counter data, read input registers 385–512. Read two consecutive registers per point.
- To clear a high-speed counter, write to coils 257–320. For example, to clear the counter on module 0, point 0, you would write a 1 to coil 257.
- To read *counters on high-density digital modules*, read input registers 513–2560 (or read and clear counters using input registers 2561–4608). Read two consecutive registers per point.

SNAP Analog I/O Point Features

Analog point features apply to all SNAP analog/digital I/O units. For explanations of point features, see [page 25](#).

Analog point features generally require that you read or write to two consecutive registers for each point, since the data is in the form of a 32-bit IEEE float. Data is in Big Endian format. You can change the word order if you wish, using the Modbus memory map. See Holding Register 1029 on [page 36](#). If you change word order, be sure to store configuration information to flash (Holding Register 1026) so it will be saved when the I/O unit is turned off.

Scaling

To scale an analog point, write the low-scale value to holding registers 7175–9222 and the high-scale value to holding registers 9223–11270. Write to two consecutive registers for each point you are scaling.

Minimum and Maximum Values

Minimum and maximum values are analog point features. The I/O unit automatically keeps track of minimum and maximum values; they do not require configuration. You can read the values at any time, for example to record minimum and maximum temperatures. You can also clear them.

- To read min/max values, read input registers 6657–10752. Read two consecutive registers per point.
- To clear min/max values, write 1 bits to coils 3585–5632.

Offset and Gain

Offset and gain are also analog point features on SNAP I/O units. Setting offset and gain for analog input points is important to make sure that values appear accurately when read. If a -50 mV to +50 mV input receives signals that are slightly off (not exactly -50 mV at the lowest point, for example), you can set offset and gain to adjust them.

Calculate offset first, and then calculate gain. The offset must be calculated at the point's low scale, and the gain must be calculated at the point's high scale.

Once you have calculated offset and gain values, write them to the I/O unit. To set offset, write to holding registers 3079–5126, using two consecutive registers per point. To set gain, write to holding registers 5127–7174.

E1 Digital Point Features

For explanations of digital point features, see [page 25](#).

Latches

Latches are a digital point feature available on E1 brain boards. They do not require configuration. Read and clear latches as shown in the following table and the Modbus memory map beginning on [page 31](#).

To do this	Use these coils/inputs
Read the on-latch state	Read inputs 65–80
Read the off-latch state	Read inputs 129–144
Clear on-latches	Write to coils 129–144
Clear off-latches	Write to coils 193–208

Counters

Using counters involves three steps: configure the counter (holding registers 769-800), activate the counter (coils 65-80), and read data (input registers 385-416). See the Modbus memory map beginning on [page 31](#) to find the coils and registers mentioned.

To do this	Use these coils/registers				
Configure a counter	Write to holding registers 769–800. Remember that you use two consecutive registers for each point, since the data is in the form of a 32-bit integer but the registers are 16 bits each. For example, to configure point #1 as a counter, you would write 01 to registers 769-770. To these registers: <table style="display: inline-table; border-collapse: collapse;"><tr><td style="border-right: 1px solid black; padding: 0 5px;">769</td><td style="padding: 0 5px;">770</td></tr><tr><td style="border-right: 1px solid black; padding: 0 5px;">Write this: 0</td><td style="padding: 0 5px;">1</td></tr></table>	769	770	Write this: 0	1
769	770				
Write this: 0	1				
Activate a counter	Write to coils 65-80. For example, to activate the counter for point #1, you would write to coil number 65.				
Read counter data	Read input registers 385–416. Read two consecutive registers per point.				
Clear a counter	Write to coils 257–272. For example, to clear the counter on point #1, you would write a 1 to coil 257.				

E2 Analog Point Features

For explanations of analog point features, see [page 25](#).

Analog point features generally require that you read or write two consecutive registers for each point, since the data is in the form of a 32-bit IEEE float. Data is in Big Endian format. You can change the word order if you wish, using Holding Register 1029, which is described on [page 36](#). If you change word order, be sure to store configuration information to flash (Holding Register 1026) so it will be saved when power to the brain board is cycled.

Scaling E2 Analog Points

Configuration of E1 and E2 brain boards is simplified in E1/E2 firmware R1.2a (and higher) and in PAC Project 9.5000 (and higher). Also, if a SNAP PAC controller communicates with the E1 or E2, the controller must have PAC firmware R9.5a (or higher) to use the simplified configuration method.

If you are not using these firmware and software versions, you must scale analog points when you configure I/O. For details, see Opto 22 [form 1576, I/O Configuration for E1 and E2 Brain Boards](#).

Minimum and Maximum Values

Minimum and maximum values (also called peaks and valleys) are automatically tracked on the E2 and do not require configuration. For example, you can read the values at any time to record minimum and maximum pressures. You can also clear them.

NOTE: The E2 does not maintain minimum and maximum values for temperature.

- To read min/max values, read input registers 129–160 (min) and 257–288 (max). Read two consecutive registers per point.
- To clear min/max values, write 1 bits to coils 321–336 (min) and 385–400 (max).

Offset and Gain

You can monitor current values for offset and gain using holding registers 129–160 and 257–288. To perform calibration on analog points, use PAC Manager. See the *PAC Manager User's Guide*.

A Note on Analog Counts

As mentioned, the configuration method for E2 I/O units was simplified in E2 firmware R1.2a and PAC Project R9.5. With the new method, you can configure E2s in PAC Control and PAC Manager just as you would other I/O units, and configure their points as G1 modules rather than similar SNAP modules.

This change makes a difference in how the E2 I/O unit reports counts. Modules configured directly as G1 modules (the new method) will report counts as G1 counts (0 to +4095 nominal range). Modules configured under the old method will report counts as SNAP counts (0 to +25000, or -25000 to +25000).

3: The Modbus Memory Map

Introduction

The following tables show the coils, inputs, input registers, and holding registers that apply to Opto 22 devices supporting Modbus/TCP. We call these the Modbus memory map.

New areas have been added to the Modbus memory map to accommodate new higher-density digital and analog modules. As a result, the functions of some coil, input, and register numbers have been duplicated in larger areas. In the following tables, the older numbers are shown in brackets. These older numbers can still be used for backward compatibility, but we recommend using the referenced larger areas for new development.

NOTE: Because digital counters and module configuration require more than one bit, they are handled in input and holding registers.

For all actions in this chapter, use a unit ID (slave ID) of 1.

If you need to take actions not shown in the following tables, see [Chapter 4](#).

Coils number

For SNAP 4-channel digital I/O modules: For these modules, up to 64 points are available on the largest SNAP I/O rack; therefore, digital coils contain 64 numbers. Each number contains the data for one point. Data is either 0 or 1.

For digital and analog I/O on E1 and E2 I/O units: These racks contain up to 16 points, so coils contain 16 numbers, each with the data for one point. Data is either 0 or 1.

For SNAP high-density digital I/O and SNAP analog minimum/maximum: Coils contain 512 numbers, with an extra 512 coils reserved. See [“Notes for High-Density Digital \(HDD\) Modules” on page 38](#) and [“The following table shows starting registers for the first point on each module on the largest rack.” on page 39](#).

The Coils table begins on the following page.

Action	Coil Numbers					Notes
	SNAP-PAC-R1 SNAP-PAC-R1-B SNAP-PAC-EB1 SNAP-B3000-ENET	SNAP-PAC-R2 SNAP-PAC-EB2 SNAP-ENET-S64 SNAP-UP1-M64	SNAP-ENET-D64 SNAP-UP1-D64	E1	E2	
Read or Write Point State on 4-channel or 1-channel digital outputs	1–64	1–64	1–64	1–16	--	1 = On, 0 = Off
Activate Counters on 4-channel or 1-channel digital modules	65–128	--	--	65–80	--	1 = On, 0 = Off. Configure as a point feature first. See “Counters” on page 26.
Read or Clear On-latch on 4-channel or 1-channel digital modules	129–192	65–128	65–128	129–144	--	1 = clear latches; 0 = do nothing
Read or Clear Off-latch on 4-channel or 1-channel digital modules	193–256	129–192	129–192	193–208	--	1 = clear latches; 0 = do nothing
Clear Counters on 4-channel or 1-channel digital modules	257–320	--	--	257–272	--	1 = clear counters; 0 = do nothing
Clear Analog Minimum Values on analog modules with 4 points or less	[321–384] ¹ Use 3585	Use 3585	--	--	321–336	1 = clear minimum values; 0 = do nothing
Clear Analog Maximum Values on analog modules with 4 points or less	[385–448] ¹ Use 4609	Use 4609	--	--	385–400	1 = clear maximum values; 0 = do nothing
Read or Write Point State on HDD ² modules	513–1536	513–1536	--	--	--	1 = On, 0 = Off
Clear On-latch (HDD ² modules)	1537–2560	1537–2560	--	--	--	1 = clear latches; 0 = do nothing
Clear Off-latch (HDD ² modules)	2561–3584	2561–3584	--	--	--	1 = clear latches; 0 = do nothing
Clear Analog Minimum Values on all analog modules	3585–4608	3585–4608	--	--	--	1 = clear minimum values; 0 = do nothing
Clear Analog Maximum Values on all analog modules	4609–5632	4609–5632	--	--	--	1 = clear minimum values; 0 = do nothing
Configure Point Type (4-channel digital)	(See Holding Registers)	(See Holding Registers)	193–256	(See Holding Registers)	(See Holding Registers)	1 - output; 0 = input
Store Configuration to Flash	(See Holding Registers)	257 (or Holding Register)	257	(See Holding Registers)	(See Holding Registers)	Using Modbus Command 05, write 1 to store point configuration data to flash. Reading always returns 0.
Reset to Factory Defaults	(See Holding Registers)	258 (or Holding Register)	258	(See Holding Registers)	(See Holding Registers)	Using Modbus Command 05, write 1 to reset. Resetting clears latches and turns off digital outputs. Reading always returns 0.

Action	Coil Numbers					Notes
	SNAP-PAC-R1 SNAP-PAC-R1-B SNAP-PAC-EB1 SNAP-B3000-ENET	SNAP-PAC-R2 SNAP-PAC-EB2 SNAP-ENET-S64 SNAP-UP1-M64	SNAP-ENET-D64 SNAP-UP1-D64	E1	E2	
Clear Point Configuration (4-channel digital)	(See Holding Registers)	259 (or Holding Register)	259	(See Holding Registers)	(See Holding Registers)	Using Modbus Command 05, write 1 to set point configuration data to defaults. Reading always returns 0.
Reset Hardware	(See Holding Registers)	260 (or Holding Register)	260	(See Holding Registers)	(See Holding Registers)	Using Modbus Command 05, write 1 to reset hardware, which is just like cycling power to the device. If point configuration data has not been stored to flash, points are reset to defaults. Reading always returns 0.

1 These coil numbers were used in the past and still work, but for new development, use the referenced coil numbers instead.

2 High-density digital (digital modules with more than 4 points)

Inputs

SNAP 4-channel digital input modules: inputs contain 64 numbers, each with the data for one point. Data is either 0 or 1.

I/O modules for E1 and E2 I/O units: inputs contain 16 numbers, each with the data for one point. Data is either 0 or 1.

SNAP high-density digital input modules: inputs contain 512 numbers, with an extra 512 numbers reserved. See “Notes for High-Density Digital (HDD) Modules” on page 38.

Action	Input Numbers					Notes
	SNAP-PAC-R1 SNAP-PAC-R1-B SNAP-PAC-EB1 SNAP-B3000-ENET	SNAP-PAC-R2 SNAP-PAC-EB2 SNAP-ENET-S64 SNAP-UP1-M64	SNAP-ENET-D64 SNAP-UP1-D64	E1	E2	
Read 4-channel Digital Inputs	1–64	1–64	1–64	1–16	--	1 = On, 0 = Off
Read State of On-latches (4-channel digital modules)	65–128	65–128	65–128	65–80	--	1 = On, 0 = Off
Read State of Off-latches (4-channel digital modules)	129–192	129–192	129–192	129–144	--	1 = On, 0 = Off
Read Counter Active State (4-channel digital modules)	193–256	--	--	193–208	--	1 = Active, 0 = Inactive
Read HDD* Modules	513–1536	513–1536	--	--	--	1 = On, 0 = Off
Read On-Latches (HDD* modules)	1537–2560	1537–2560	--	--	--	1 = On, 0 = Off
Read Off-Latches (HDD* modules)	2561–3584	2561–3584	--	--	--	1 = On, 0 = Off

* High-density digital (digital modules with more than 4 points)

Input Registers

Input register data is in the form of 32-bit floats or 32-bit integers. Because Modbus registers contain only 16 bits, you must use two consecutive registers to read the data for one point, starting with an odd-numbered register.

This table includes registers for 1-, 2-, 4-, 8-, and 32-channel analog modules. For help in working with **analog modules**, see “Notes for All Analog Modules” on page 36.

For **high-density digital** modules, see “Notes for High-Density Digital (HDD) Modules” on page 38.

Action	Input Register Numbers					Notes
	SNAP-PAC-R1 SNAP-PAC-R1-B SNAP-PAC-EB1 SNAP-B3000-ENET SNAP-UP1-ADS	SNAP-PAC-R2 SNAP-PAC-EB2 SNAP-ENET-S64 SNAP-UP1-M64	SNAP-ENET-D64 SNAP-UP1-D64	E1	E2	
Read Analog Values on analog modules with 4 points or less	[1–128] ¹ Use 4609	[1–128] ¹ Use 4609	--	--	1–32	IEEE 32-bit float
Read Analog Minimum Values (Inputs only; modules with 4 points or less)	[129–256] ¹ Use 6657	[129–256] ¹ Use 6657	--	--	129–160	IEEE 32-bit float
Read Analog Maximum Values (Inputs only; modules with 4 points or less)	[257–384] ¹ Use 8705	[257–384] ¹ Use 8705	--	--	257–288	IEEE 32-bit float
Read Digital Counter Data on 4-channel or 1-channel digital modules	385–512	--	--	385–416	--	32-bit integer
Read Digital Counter Data on HDD ² modules	513–2560	513–2560	--	--	--	32-bit integer
Read & Clear Digital Counter Data on HDD ² modules	2561–4608	2561–4608	--	--	--	32-bit integer
Read Analog Values (all analog modules)	4609–6656	4609–6656	--	--	--	IEEE 32-bit float
Read Analog Minimum Values (all analog input modules)	6657–8704	6657–8704	--	--	--	IEEE 32-bit float
Read Analog Maximum Values (all analog input modules)	8705–10752	8705–10752	--	--	--	IEEE 32-bit float

¹ These register numbers were used in the past and still work, but for new development, use the referenced numbers instead.

² High-density digital (digital modules with more than 4 points)

You can read a maximum of 127 registers in one command.

Holding Registers

Most of this data is also in the form of 32-bit integers or 32-bit floats. For these formats, you must use two consecutive registers to read or write the data for one point, starting with an odd-numbered register.

This table includes registers for 1-, 2-, 4-, 8-, and 32-channel analog modules. For help in working with **analog modules**, see “Notes for All Analog Modules” on page 36.

Action	Holding Register Numbers					Notes
	SNAP-PAC-R1 SNAP-PAC-R1-B SNAP-PAC-EB1 SNAP-B3000-ENET SNAP-UP1-ADS	SNAP-PAC-R2 SNAP-PAC-EB2 SNAP-ENET-S64 SNAP-UP1-M64	SNAP-ENET-D64 SNAP-UP1-D64	E1	E2	
Read or Write Analog Outputs in Engineering Units (modules with 4 points or less)	[1–128] ¹ Use 1031	[1–128] ¹ Use 1031	--	--	1–32	IEEE 32-bit float
Set Analog Offset (modules with 4 points or less)	[129–256] ¹ Use 3079	[129–256] ¹ Use 3079	--	--	129–160	IEEE 32-bit float
Set Analog Gain (modules with 4 points or less)	[257–384] ¹ Use 5127	[257–384] ¹ Use 5127	--	--	257–288	IEEE 32-bit float
Set Point Low Scale Value (modules with 4 points or less)	[385–512] ¹ Use 7175	[385–512] ¹ Use 7175	--	--	385–416	IEEE 32-bit float
Set Point High Scale Value (modules with 4 points or less)	[513–640] ¹ Use 9223	[513–640] ¹ Use 9223	--	--	513–544	IEEE 32-bit float
Configure Points (modules with 4 points or less)	[641–768] ¹ Use 11271	[641–768] ¹ Use 11271	See Coils	641–672 ²	641–672 ²	32-bit integer (See page 17 for information on configuring points.)
Configure Point Features (counters on 4-channel or 1-channel digital modules)	[769–896] ¹ Use 13319	Use 13319	--	769–800	--	32-bit integer (See page 25 for information on counters.)
Reserved	897–1024	769–1024	--	897–1024	897–1024	Reserved
Set Degrees in F or C	1025	1025	--	--	1025	16-bit integer. 1 sets degrees in F; 0 sets degrees in C.
Store Configuration to Flash	1026	1026 (Or Coil 257)	See Coils	1026	1026	16-bit integer. Any non-zero value stores configuration to flash, so it is restored when the brain is turned on. 0 = no action.
Reset to Factory Defaults	1027	1027 (Or Coil 258)	See Coils	1027	1027	16-bit integer. Any non-zero value resets the brain to defaults as follows: Clears offsets and gains, counters, latches, and min/max data; turns off digital outputs; sets analog outputs to zero scale (0 counts). (1027 is equal to 1028 followed by 1030.)
Clear Point Configuration	1028	1028 (Or Coil 259)	See Coils	1028	1028	16-bit integer. Any non-zero value clears flash.

Action	Holding Register Numbers					Notes
	SNAP-PAC-R1 SNAP-PAC-R1-B SNAP-PAC-EB1 SNAP-B3000-ENET SNAP-UP1-ADS	SNAP-PAC-R2 SNAP-PAC-EB2 SNAP-ENET-S64 SNAP-UP1-M64	SNAP-ENET-D64 SNAP-UP1-D64	E1	E2	
Set 32-bit Float Format	1029	1029	--	1029	1029	16-bit integer. 0 = Big Endian; 1 = Word-swapped Big Endian.
Hardware Reset	1030	1030 (Or Coil 260)	See Coils	1030	1030	Using Modbus Command 06, write any non-zero value to reset hardware, which is like cycling power to the brain. If point configuration data has not been stored to flash or flash has been cleared (1028), points are reset to defaults. Reading always returns 0.
Read or Write Analog Outputs (all analog modules)	1031–3078	1031–3078	--	--	--	IEEE 32-bit float
Set Analog Offset (all analog modules)	3079–5126	3079–5126	--	--	--	IEEE 32-bit float
Set Analog Gain (all analog modules)	5127–7174	5127–7174	--	--	--	IEEE 32-bit float
Set Point Low Scale Value (all analog modules)	7175–9222	7175–9222	--	--	--	IEEE 32-bit float
Set Point High Scale Value (all analog modules)	9223–11270	9223–11270	--	--	--	IEEE 32-bit float
Configure Points (all modules)	11271–13318	11271–13318	--	--	--	32-bit integer
Configure Point Features (all modules)	13319–15366	13319–15366	--	--	--	32-bit integer

1 These register numbers were used in the past and still work, but for new development, use the referenced numbers instead.

2 The method to configure E1 and E2 brain boards is simplified in E1/E2 firmware R1.2a (and higher) and in PAC Project 9.5000 (and higher). Also, if a SNAP PAC controller communications with the E1 or E2, the controller must have PAC firmware R9.5a (or higher) to use the simplified configuration method. If you are not using these firmware and software versions (or if you prefer to use the previous method to reconfigure existing E1s or E2s), see Opto 22 [form 1576, I/O Configuration for E1 and E2 Brain Boards](#).

You can read a maximum of 127 registers in one command.

Notes for All Analog Modules

Changes have been made to the Modbus memory map to accommodate higher-density SNAP analog input and output modules. Analog modules range from 1 to 32 points. Adjust your reads and writes depending on the module you have; for example, if your analog module has two points, use only the registers for the first two points. If it has eight points, use only the registers for the first eight points.

Coils contain 32 numbers per module for clearing analog minimum and maximum values. Data for each coil is either 0 or 1. Registers and corresponding points for a 32-channel analog module in position 0 are shown below as an example:

Coil	3585	3586	3587	3588	3589	3590	3591	3592	→	3609	3610	3611	3612	3613	3614	3615	3616
Point	1	2	3	4	5	6	7	8	→	25	26	27	28	29	30	31	32

Input and holding registers contain 64 registers for each module (since the data for each point requires two registers). For example, on a 32-channel analog module in position 0:

Register	4609	4611	4613	4615	4617	4619	4621	4623	→	4657	4659	4661	4663	4665	4667	4669	4671
	4610	4612	4614	4616	4618	4620	4622	4624	→	4658	4660	4662	4664	4666	4668	4670	4672
Point	1	2	3	4	5	6	7	8	→	25	26	27	28	29	30	31	32

Analog Module Register Table

The following table shows **starting registers** for the first point on each module on the largest rack.

Module Position	Coils		Input Registers			Holding Registers						
	Clear Min Value	Clear Max Value	Read Value	Read Min Value	Read Max Value	Read/Write Output	Calculate Offset	Calculate Gain	Set Low Scale	Set High Scale	Config Point	Config Feature
0	3585	4609	4609	6657	8705	1031	3079	5127	7175	9223	11271	13319
1	3617	4641	4737	6785	8833	1159	3207	5255	7303	9351	11335	13383
2	3649	4673	4865	6913	8961	1287	3335	5383	7431	9479	11399	13447
3	3681	4705	4993	7041	9089	1415	3463	5511	7559	9607	11463	13511
4	3713	4737	5121	7169	9217	1543	3591	5639	7687	9735	11527	13575
5	3745	4769	5249	7297	9345	1671	3719	5767	7815	9863	11591	13639
6	3777	4801	5377	7425	9473	1799	3847	5895	7943	9991	11655	13703
7	3809	4833	5505	7553	9601	1927	3975	6023	8071	10119	11719	13767
8	3841	4865	5633	7681	9729	2055	4103	6151	8199	10247	11783	13831
9	3873	4897	5761	7809	9857	2183	4231	6279	8327	10375	11847	13895
10	3905	4929	5889	7937	9985	2311	4359	6407	8455	10503	11911	13959
11	3937	4961	6017	8065	10113	2439	4487	6535	8583	10631	11975	14023
12	3969	4993	6145	8193	10241	2567	4615	6663	8711	10759	12039	14087
13	4001	5025	6273	8321	10369	2695	4743	6791	8839	10887	12103	14151
14	4033	5057	6401	8449	10497	2823	4871	6919	8967	11015	12167	14215
15	4065	5089	6529	8577	10625	2951	4999	7047	9095	11143	12231	14279

Change in reporting analog counts for E2

The configuration method for E2 I/O units was simplified in E2 firmware R1.2a and PAC Project R9.5. With the new method, you can configure E2s in PAC Control and PAC Manager just as you would other I/O units, and configure their points as G1 modules rather than similar SNAP modules.

This change makes a difference in how the E2 I/O unit reports counts. Modules configured directly as G1 modules (the new method) will report counts as G1 counts (0 to +4095 nominal range). Modules configured under the old method will report counts as SNAP counts (0 to +25000, or -25000 to +25000).

Notes for High-Density Digital (HDD) Modules

SNAP high-density digital input and output modules contain more than 4 points per module. They have been handled differently in the Modbus memory map because additional registers have been reserved.

Coils and inputs contain 32 numbers for each module, with an additional 32 reserved. Data for each number is either 0 or 1. Numbers and corresponding points for a 32-channel HDD module in position 0 are shown below as an example:

Coil/Input	513	514	515	516	517	518	519	520	————→	537	538	539	540	541	542	543	544
Point	1	2	3	4	5	6	7	8	————→	25	26	27	28	29	30	31	32

Coils or inputs from 545–576 are reserved, and then Module 1 starts at 577. On a 16-point HDD module, module 0 would use coils or inputs 513–528; numbers 529–576 are reserved; and module 1 would still start at 577. See [“High-Density Digital Module Register Table” on page 39](#) for additional module starting numbers.

Registers contain 64 numbers for each module (since the data for each point requires two registers), and an additional 64 registers are reserved. For example, on a 32-channel module in position 0:

Register	513	515	517	519	521	523	525	527	————→	561	563	565	567	569	571	573	575
	514	516	518	520	522	524	526	528	————→	562	564	566	568	570	572	574	576
Point	1	2	3	4	5	6	7	8	————→	25	26	27	28	29	30	31	32

Registers 577–640 are reserved, and then module 1 starts at 641. See the table below for additional modules.

High-Density Digital Module Register Table

The following table shows starting registers for the first point on each module on the largest rack.

Module Position	Coils/Inputs			Input Registers	
	State	On-Latch State	Off-Latch State	Counter Data	Read & Clear Counter
0	513	1537	2561	513	2561
1	577	1601	2625	641	2689
2	641	1665	2689	769	2817
3	705	1729	2753	897	2945
4	769	1793	2817	1025	3073
5	833	1857	2881	1153	3201
6	897	1921	2945	1281	3329
7	961	1985	3009	1409	3457
8	1025	2049	3073	1537	3585
9	1089	2113	3137	1665	3713
10	1153	2177	3201	1793	3841
11	1217	2241	3265	1921	3969
12	1281	2305	3329	2049	4097
13	1345	2369	3393	2177	4225
14	1409	2433	3457	2305	4353
15	1473	2497	3521	2433	4481

4: Accessing Other Data

Introduction

In most cases, communication between Modbus/TCP and Opto 22 systems uses the Modbus memory map detailed in [Chapter 3](#), which was designed to make communication easier. Always look in [Chapter 3](#) first to see if the data you want is available there.

However, if you need to read and write data in additional areas of the device's memory map not covered in [Chapter 3](#), you can do so with any of the following controllers or I/O units:

SNAP-PAC-S1	OPTOEMU-SNR-DR1
SNAP-PAC-R1	OPTOEMU-SNR-DR2
SNAP-PAC-R1-B	SNAP-B3000-ENET
SNAP-PAC-R2	SNAP-ENET-S64
SNAP-PAC-EB1	SNAP-UP1-M64
SNAP-PAC-EB2	SNAP-UP1-ADS
OPTOEMU-SNR-3V	

NOTE: Digital-only I/O units and E1 and E2 I/O units do not support this advanced Modbus programming.

Why Access Other Data?

Some common reasons for needing to access other data in a device's memory map include:

- Finding out the device's unit type and firmware revision.
- Reading data placed in the device's Scratch Pad area (for example, by a PAC Control strategy or by another device) or writing data to the device's Scratch Pad. Scratch Pad areas may include bits, integers, floats, and strings, depending on the device. See form1704, [PAC Manager User's Guide](#), for more information on Scratch Pad areas.

Accessible Data

All of the Opto 22 device's regular OptoMMP memory map addresses in the range F000 0000 to F1EB FFFE are directly available for reading and writing.

Addresses outside that range (or scattered addresses) may be indirectly accessed in one contiguous chunk by using the Custom Data Access Area (F0D6 0000 to F0D6 0FFC) and Custom Configuration

Area (F0D5 0000 to F0D5 0FFC) to map selected addresses into one area that is available for Modbus reads and writes.

The complete OptoMMP memory map is in an appendix in Opto 22 form 1465, *OptoMMP Protocol Guide*. This guide is available on our website, www.opto22.com; you'll need it to obtain memory map addresses, data type, and data length. For some addresses you'll also need this guide to interpret the data you receive (for example, a firmware version) or to know what data to send.

You can also use the Modbus Calculator in PAC Manager to convert memory map addresses to their corresponding Modbus values.

When you're working with the memory map addresses in the *OptoMMP Protocol Guide*, remember that they refer to Opto 22 input/output points, which are zero-based. That is, the first module position is position 0, and the first point on any module is point 0.

Modbus Master Requirements

As explained in [Chapter 1](#), Opto 22 devices use a Modbus packet inside TCP/IP. The Modbus checksum is not used; instead, the Ethernet TCP/IP link layer checksum guarantees data. The size of the packet is limited to 256 bytes.

In order to access additional memory map addresses, the Modbus master needs to support Class 0 commands and the following function codes:

- 03 Read holding registers
- 06 Preset single register
- 10 Preset multiple registers

Determining Modbus Unit ID and Register

For the Modbus Memory Map in [Chapter 3](#), you always use a unit ID (slave ID) of 1. However, Opto 22 memory mapped devices contain far more data than can fit in the registers provided by the Modbus protocol. To add more data, we used additional unit IDs.



To read and write to these other areas of the memory map, you need to determine the Modbus Unit ID and Register Address that are equivalent to the I/O unit's memory map address.

The easiest way is to use PAC Manager software to convert addresses. PAC Manager is included on the CD that came with the Opto 22 device; it is also available for download from our website, www.opto22.com (search on PAC Manager).

The basic steps for determining the Modbus Unit ID and Register are shown below; see form 1704, *PAC Manager User's Guide* for additional help. Or you can use form 1465, *OptoMMP Protocol Guide*, to find the memory map addresses. Both guides are available on our website at www.opto22.com.

Finding OptoMMP Memory Map Addresses

Find the memory map address you need by locating it in form 1465, *OptoMMP Protocol Guide*, or by using PAC Manager's Inspect window. Here's how to use PAC Manager's Inspect window to find an address. The Opto 22 device must be accessible from your PC in order to use this method.

1. Start PAC Manager as follows:
 - In Windows 7 and Windows Vista, press the Windows Start key , and then click Programs > Opto 22 > PAC Project 9.5 > PAC Manager.
 - In Windows 10 and Windows 8.1, press the Windows Start key , type PAC Manager 9.5 and then press the Enter key.

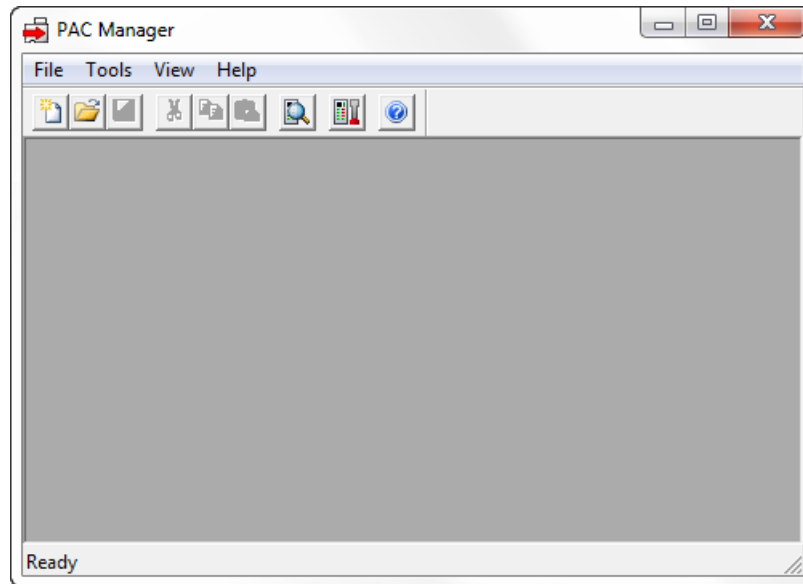

2. Click the Inspect icon .

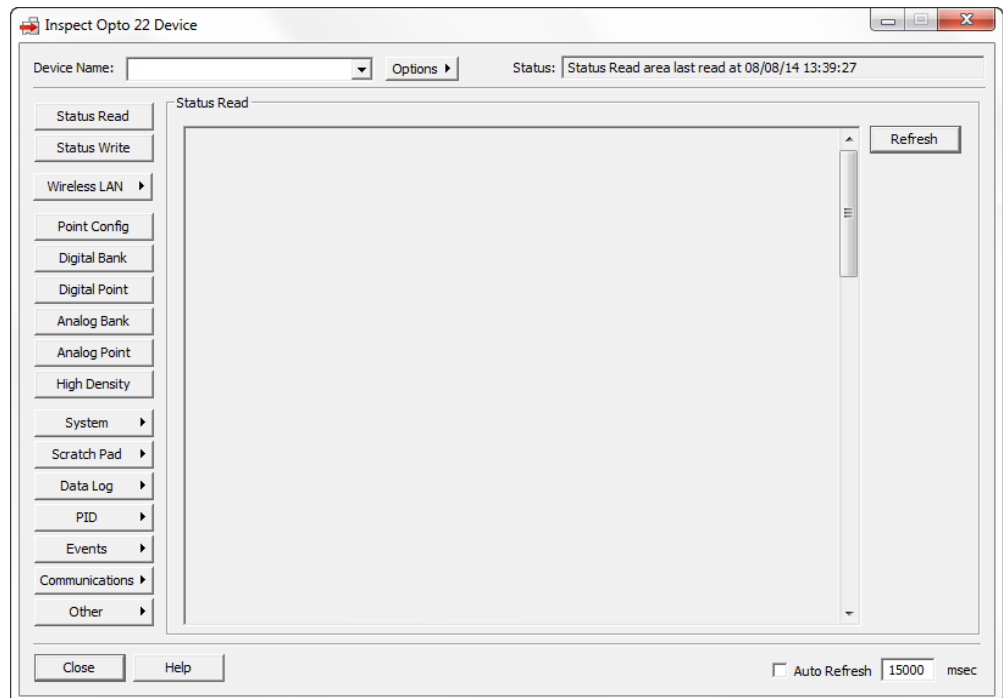

3. Type the device's name or IP address in the Device Name field. Then click the button on the left side of the window that corresponds to the memory map address you need to find.
For example, to find the memory map address for the device's firmware version, click Status Read.

Memory map address for Firmware Version

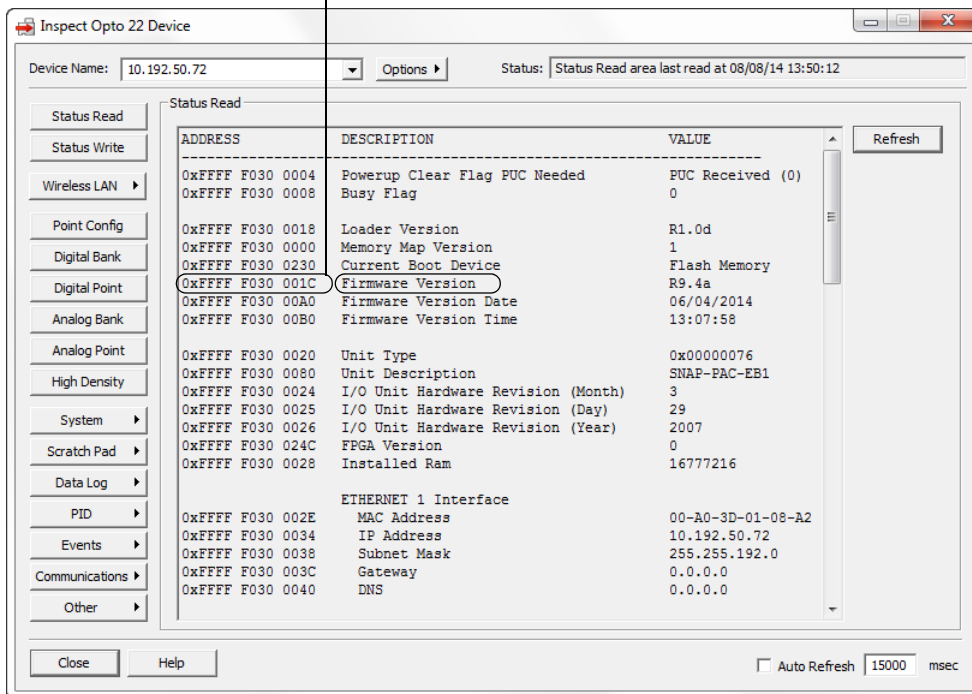

You need to know only the last eight digits of the memory map address, in this case, F030001C.

Converting OptoMMP Memory Map Addresses

Now that you have found the memory map addresses you need, you can convert them.

1. From PAC Manager's Tools menu, choose Modbus Calculator.

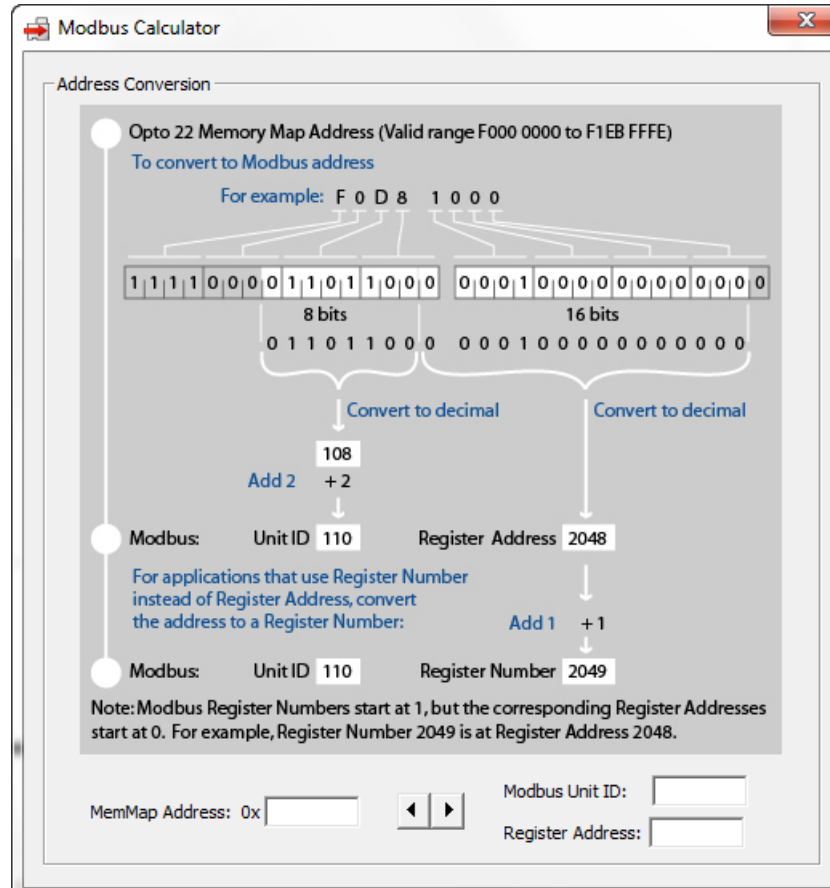

2. To convert an I/O unit memory map address to a Modbus Unit ID and Register Address, type the last eight digits of the I/O unit's memory map address in the MemMap Address field. Make sure there are no spaces in the address (for example, type F0300020).

3. Click the right-arrow icon .

The equivalent Modbus Unit ID and Register appear.

NOTE: The Modbus unit ID and registers are decimal.

Example: Reading an OptoMMP Memory Map Address

For example, suppose you want to read the status of Scratch Pad bits. You can determine the memory map address in one of two ways:

- Use the PAC Manager Inspect window to find the address you want and copy it.
- Look in the *OptoMMP Protocol Guide*, find Scratch Pad addresses, and locate the address for the current state of Scratch Pad bits.

Either way, you determine that the memory map address is F0D80000. Using PAC Manager, you convert the MemMap address F0D80000 to a Unit ID of 110 and a Register Number of 0.

See the *OptoMMP Protocol Guide* to interpret the data you read.

Example: Writing to an OptoMMP Memory Map Address

As another example, suppose you want to send a powerup clear (PUC) to the Opto 22 device. This operation code is in the Status Write area of the I/O unit's memory map address. To determine the address and format of the data to write in order to send a PUC, check the Status Write area in .

From the memory map appendix, you determine that the memory map address for an operation code is F0380000, and the specific data you must write to send a PUC is 0x00000001. Using the Modbus conversion page, you find that address F0380000 equals a Unit ID of 30 and a Register Number of 0.

Index

A

- analog point
 - gain, definition, 26
 - maximum value, definition, 25
 - minimum value, definition, 25
 - offset, definition, 26
 - on E2
 - counts, 38
 - features, 28
 - gain, 29
 - minimum/maximum values, 28
 - offset, 29
 - reading and writing value, 14
 - scaling, 28
 - on SNAP, 36
 - configuration example, 24
 - features, 26
 - gain, 27
 - minimum/maximum values, 27
 - offset, 27
 - reading and writing value, 11
 - scaling, 27
 - point types, inputs, 18
 - point types, outputs, 24
 - scaling, definition, 25
 - value, definition, 25

C

- calibrating analog input points, 26
- coils, 31
- communication overview, 5
- communication packet format, 7
- configuring I/O point
 - SNAP analog/digital, 17
 - SNAP digital-only, 25
- control strategy and Modbus, 4

counter

- definition, 25
- E1 digital point, 28
- SNAP digital point, 26

D

- data, Modbus float format, 27, 28
- digital point
 - counter, definition, 25
 - latch, definition, 25
 - on E1
 - counters, 28
 - features, 27
 - latches, 27
 - reading and writing value, 14
 - on SNAP
 - configuration example, 24
 - counters, 26
 - features, 26
 - high-density digital, 38
 - latches, 26
 - reading and writing state, 10
 - state, definition, 25
- documentation, 2

E

- E2 analog counts, 38
- error codes, 7
- exception codes, 7

F

- firmware revision, determining, 41
- float format, Modbus, 27, 28
- format
 - of communication packet, 7

of Modbus float, 27, 28
function codes for Modbus/TCP, 6

G

G4 I/O, 14
G4D32EB2
 I/O module position, 14
G4EB2
 I/O module position, 14
gain
 definition, 26
 E2 analog point, 29
 SNAP analog point, 27

H

hardware used with Modbus/TCP, 3
help, 3
high-density digital modules, 38
holding registers, 35

I

I/O features
 definitions, 25
 E1 digital point, 27
 E2 analog point, 28
 SNAP analog point, 26
 SNAP digital point, 26
I/O module
 position on E1 rack, 13
 position on E2 rack, 13
 position on G4EB2 or G4D32EB2 rack, 14
 position on SNAP rack, 9
I/O point
 configuring SNAP analog/digital, 17
 configuring SNAP digital-only, 25
 features, 26
 point types, 17
 position on E1 rack, 13
 position on E2 rack, 13
 position on SNAP rack, 9
 SNAP configuration examples, 24
I/O, SNAP, high-density digital, 38
input registers, 34
inputs, 33

L

latches
 definition, 25

E1 digital point, 27
SNAP digital point, 26

M

maximum value, 25
minimum value, 25
minimum/maximum value
 E2 analog point, 28
 SNAP analog point, 27
Modbus
 and PAC Control strategy, 4
 coils, 31
 communicating with Opto 22 devices, 3
 communication diagram, 4
 communication overview, 5
 communication packet, 7
 exception errors, 7
 float format, 27, 28
 function codes supported, 6
 holding registers, 35
 input registers, 34
 inputs, 33

O

off-latch, 25
offset
 definition, 26
 E2 analog point, 29
 SNAP analog point, 27
on-latch, 25
Opto 22 hardware, 3
Opto 22 memory-mapped protocol, 3
Opto 22 product support, 3
OptoMMP, 3
 finding memory map addresses, 42
 memory map, reading and writing to, 41

P

PAC Control, 4
PAC Manager, 42
peak, 25
point types, SNAP, 17
product support, 3

Q

Quad Pak, 13
Quad Pak I/O, 14

R

- reading
 - E1 digital points, 14
 - E2 analog points, 14
 - SNAP analog modules, 36
 - SNAP analog points, 11
 - SNAP digital points, 10
 - SNAP high-density digital modules, 38
- report slave ID command, 7

S

- scaling
 - description, 25
 - E2 analog point, 28
 - SNAP analog point, 27
- Scratch Pad, reading or writing to, 41
- SNAP I/O
 - point configuration examples, 24
 - point types, 17
- state of digital point, definition, 25

T

- technical support, 3
- troubleshooting
 - exception errors, 7

V

- valley, 25
- value of analog point, definition, 25

W

- writing
 - E1 digital points, 14
 - E2 analog points, 14
 - SNAP analog modules, 36
 - SNAP analog points, 11
 - SNAP digital points, 10
 - SNAP high-density digital modules, 38

