

DIRIS A20

Operating instructions

GB F E



DANGER AND WARNING	3
PRELIMINARY OPERATIONS	3
PRESENTATION.....	3
INSTALLATION.....	4
PROGRAMMING.....	9
OPERATION	18
CONNECTION TEST FUNCTION.....	21
TECHNICAL CHARACTERISTICS.....	24
ASSISTANCE	26
GLOSSARY OF ABBREVIATIONS	26

DANGER ET AVERTISSEMENT	29
OPERATIONS PREALABLES	29
PRESENTATION.....	29
INSTALLATION.....	30
PROGRAMMATION.....	35
UTILISATION	44
FONCTION DE TEST DU RACCORDEMENT	47
CARACTERISTIQUES TECHNIQUES	50
ASSISTANCE	52
LEXIQUE DES ABREVIATIONS.....	52

ADVERTENCIA.....	55
OPERACIONES PREVIAS	55
PRESENTACIÓN	55
INSTALACIÓN	56
PROGRAMACIÓN	61
UTILIZACIÓN.....	70
CONEXIÓN PRUEBA FUNCIÓN	73
CARACTERÍSTICAS TÉCNICAS	76
ASISTENCIA.....	78
LÉXICO DE LAS ABREVIACIONES.....	78

DIRIS A20

DANGER AND WARNING

This equipment must be mounted only by professionals.
The manufacturer shall not be held responsible for failure to comply with the instructions in this manual.

Risk of electrocution, burns or explosion

- The device must be installed and serviced only by qualified personnel.
- Prior to any work on or in the device, isolate the voltage inputs and auxiliary power supplies and short-circuit the secondary winding of all current transformers (PTI SOCOMEC).
- Always use an appropriate voltage detection device to confirm the absence of voltage.
- Put all mechanisms, door and covers back in place before energising the device.
- Always supply the device with the correct rated voltage.

Failure to take these precautions could cause serious injuries.

Risk of damaging device

Check the following:

- The voltage of the auxiliary power.
- The frequency of the distribution system (50 or 60 Hz).
- The maximum voltage across the voltage-input terminals, (V1, V2, V3 and VN) 520 V AC phase-to-phase or 300 V AC phase-to-neutral.
- A maximum current of 6 A on the current-input terminals (I1, I2 and I3).

PRELIMINARY OPERATIONS

For personnel and product safety please read the contents of these operating instructions carefully before connecting.

Check the following points as soon as you receive the **DIRIS A20** package:

- the packing is in good condition,
- the product has not been damaged during transit,
- the product reference number conforms to your order,
- the package contains the product fitted with a pull-out terminal block,
- operating instructions.

PRESENTATION

DIRIS A20 are multifunction meters which make available to the user, all the necessary steps in order to carry out energy efficiency projects and monitor the electrical distribution.

1. Key-pad with 4 dual-function keys (display or programming)
2. Backlit LCD display
3. Phase
4. Values
5. Unit
6. Activity indicator on the communication bus
7. Energy metering indication

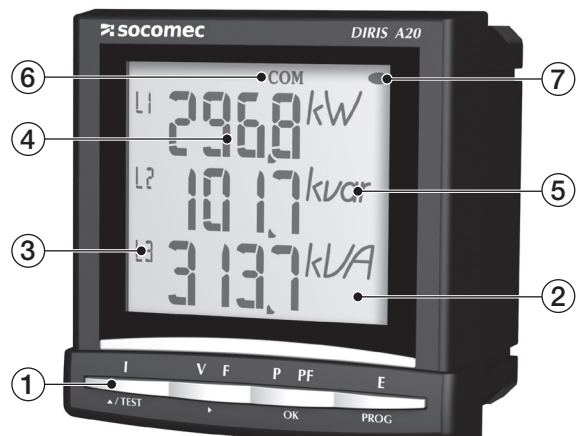

DIRIS A20

INSTALLATION

RECOMMENDATIONS

- Avoid proximity to systems which generate electromagnetic interference.
- Avoid vibrations with accelerations in excess of 1 g for frequencies below 60 Hz.

CUT-OUT DIAGRAM

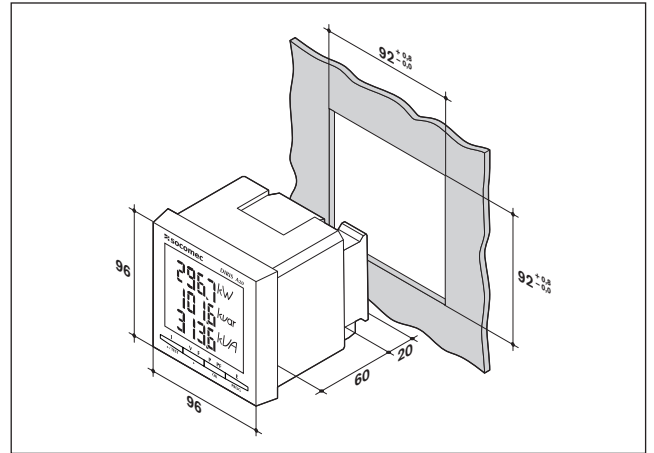

MOUNTING

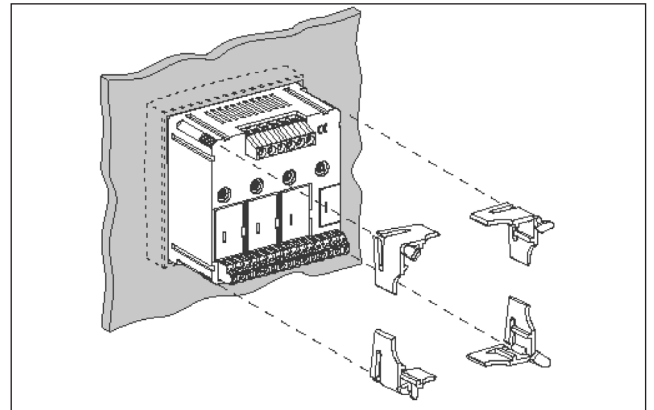

DIRIS A20

INSTALLATION

CONNECTION

The maximum coupling torque for each screw is 0.4 Nm.
 Each CT's secondary winding must be short-circuited when disconnecting the DIRIS. This can be done automatically using one of SOCOMEC's catalogue products: the PTI. Please contact us for further information.

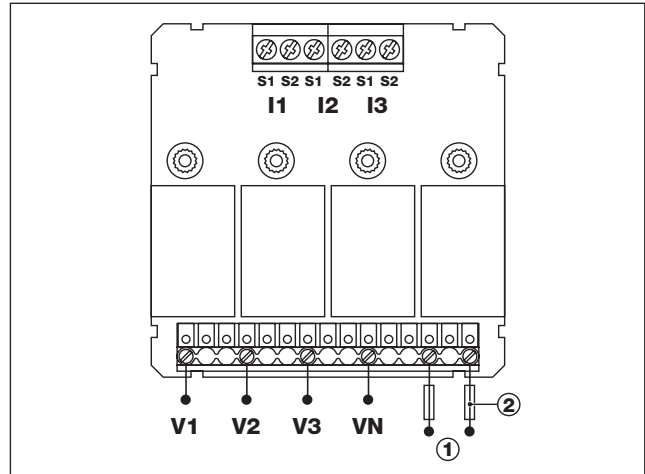

① Aux.:	IEC/CE	110... 400V AC 120... 350V DC
	UL	110... 240V AC 120... 250V DC

② Fus.: 0.5 A gG / BS 88 2A gG / 0.5 A class CC

OPTIONAL MODULES

The **DIRIS A20** can be fitted with optional modules:

- **JBUS/MODBUS communication (ref: 48250082)**
 RS485 JBUS/MODBUS serial port in RTU mode with a speed from 2400 to 38400 baud.
 (User manual ref: 536085).
- **Pulse output (ref: 48250080)**
 1 pulse output which can be configured for any of the below functions:
 - pulse: to represent energy in kWh or kvarh;
 - alarm: to monitor from a range of electrical values (current, voltage, frequency, etc.);
 - remote control of external switching- or control devices.
 (User manual ref: 536037).

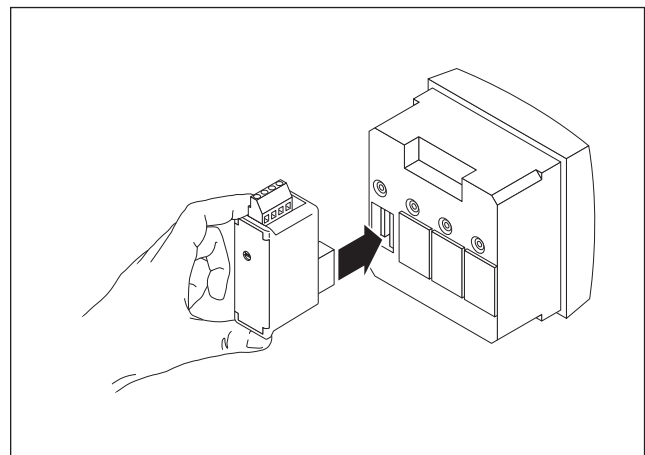

DIRIS A20

INSTALLATION

UNBALANCED THREE-PHASE NETWORK (3NBL / 4NBL)

The solution with 2 CTs with the phase current calculated via vectoral summation, results in an 0.5% reduction in phase accuracy.

⚠ In IT load, do not connect the secondary of CTs with the earth

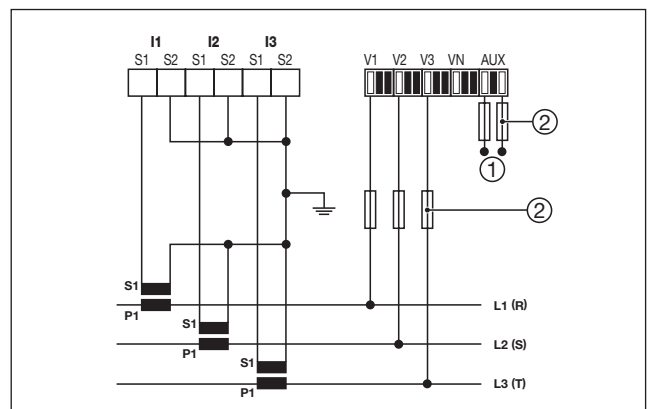
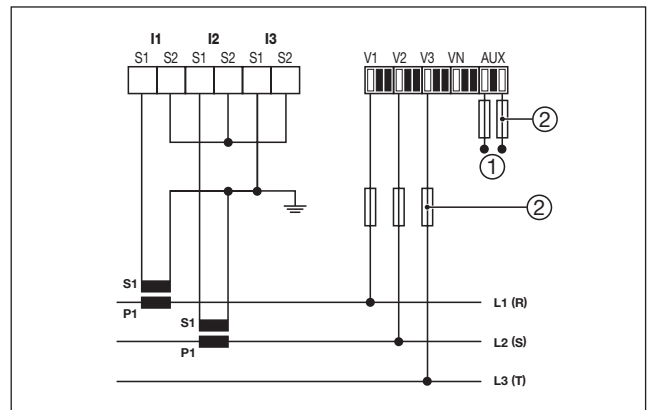
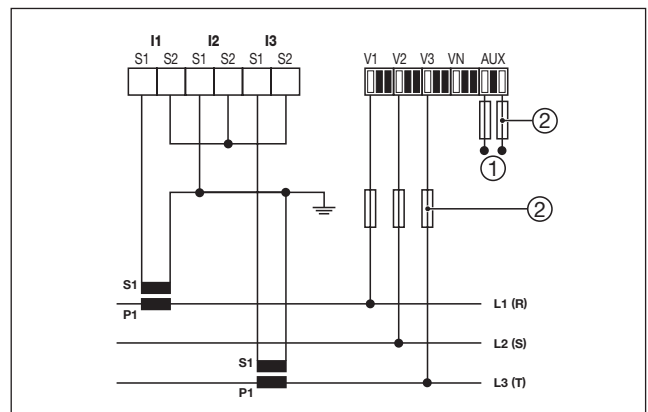
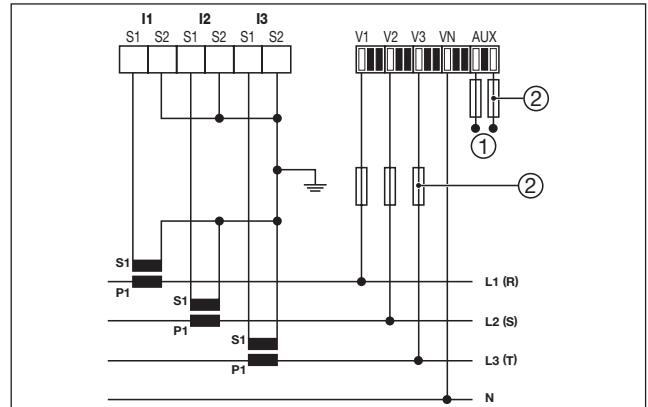

① Aux.: IEC/CE 110... 400V AC
120... 350V DC

UL 110... 240V AC
120... 250V DC

② Fus.: 0.5 A gG / BS 88 2A gG / 0.5 A class CC

BALANCED THREE-PHASE NETWORK (3BL/4BL)

The solution using one CT, with the phases current calculated via vectoral summation, results in an 0.5% reduction in phase accuracy.

 In IT load, do not connect the secondary of CTs with the earth

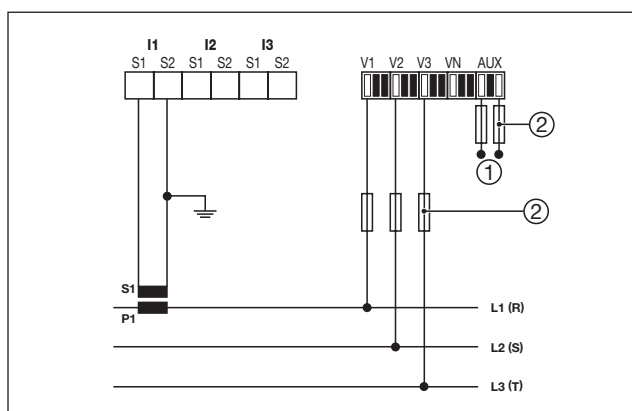
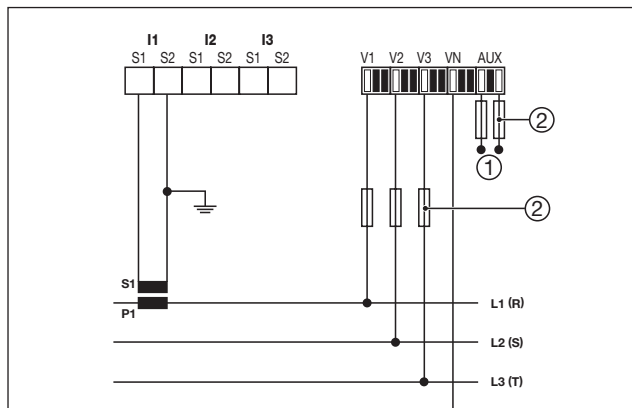

① Aux.: IEC/CE 110... 400V AC
 120... 350V DC

 UL 110... 240V AC
 120... 250V DC

② Fus.: 0.5 A gG / BS 88 2A gG / 0.5 A class CC

DIRIS A20

PROGRAMMING

PROGRAMMING MENU

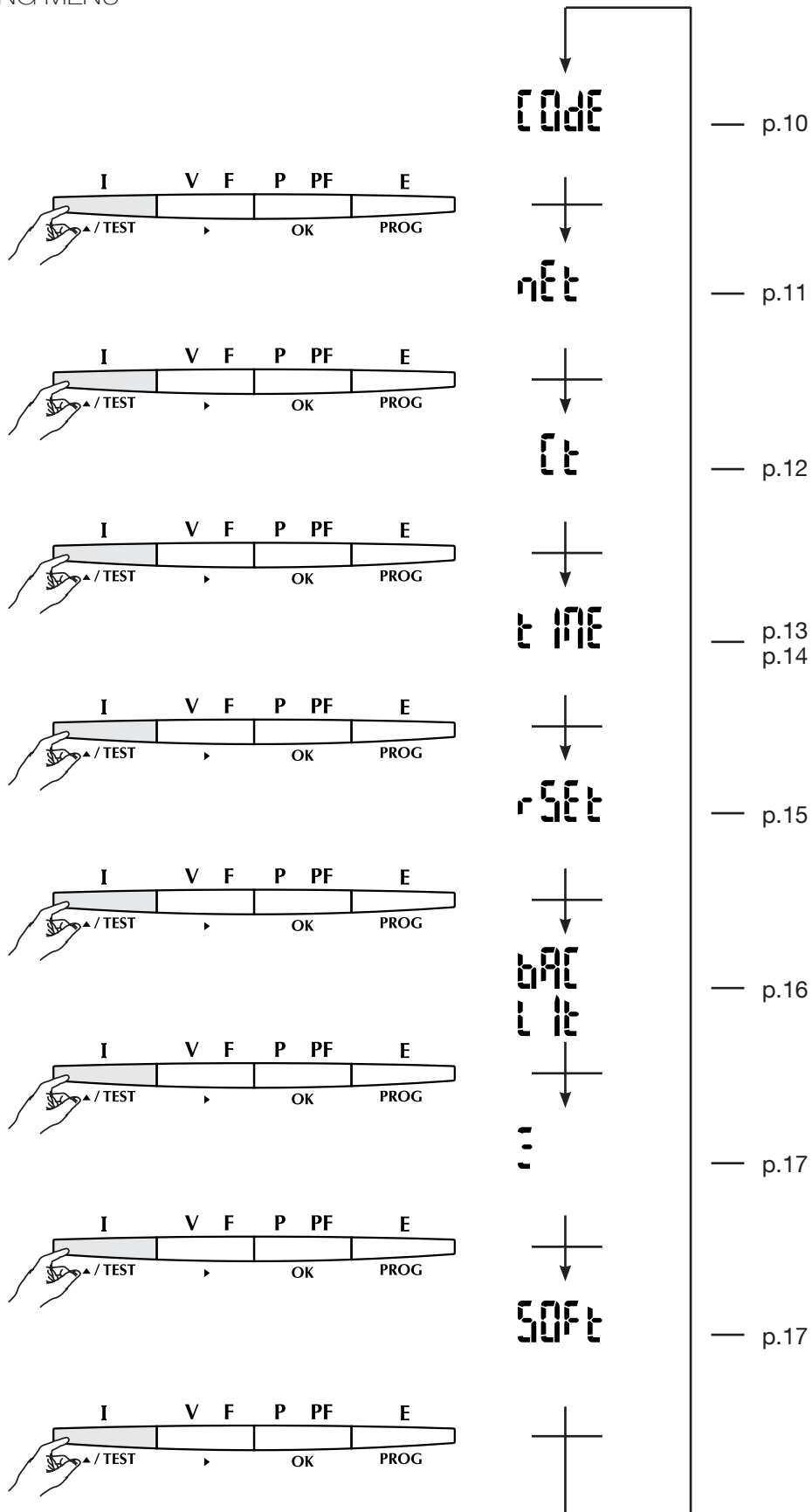

DIRIS A20

PROGRAMMING

ACCES TO PROGRAMMING MODE (example, COdE = 100)

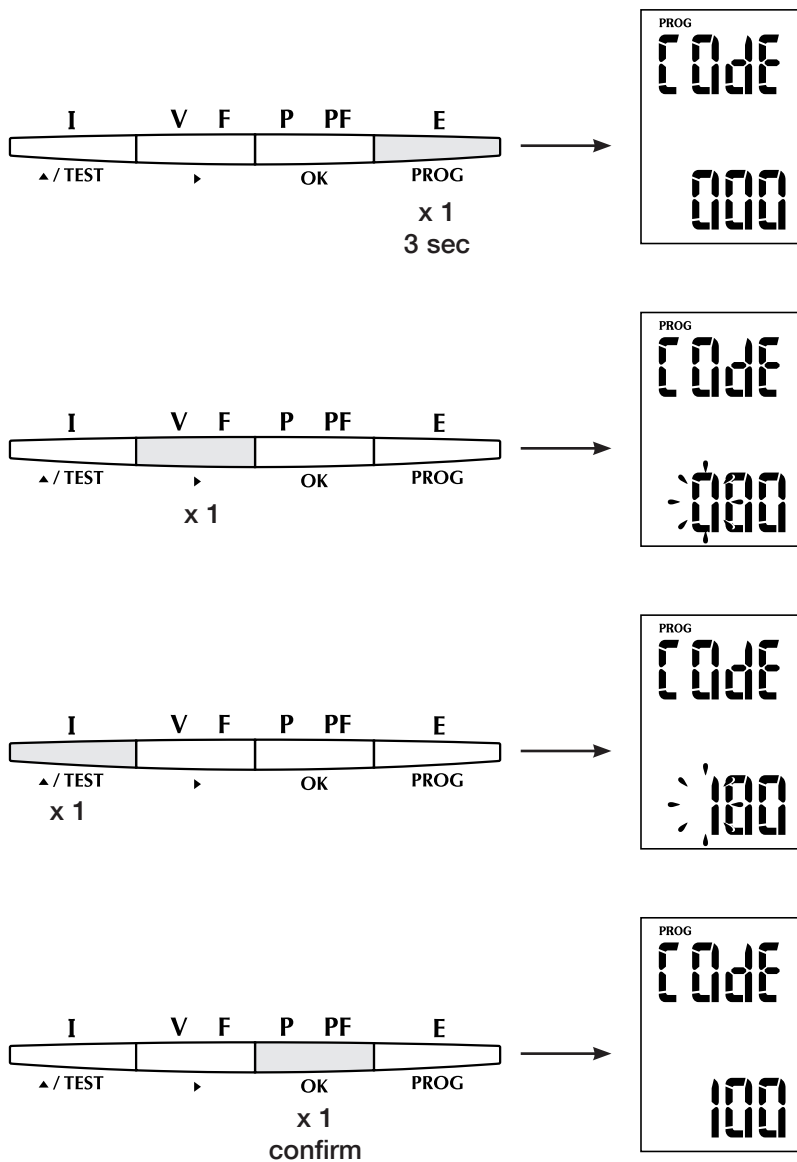

NETWORK (example, nEt = 3nbl)

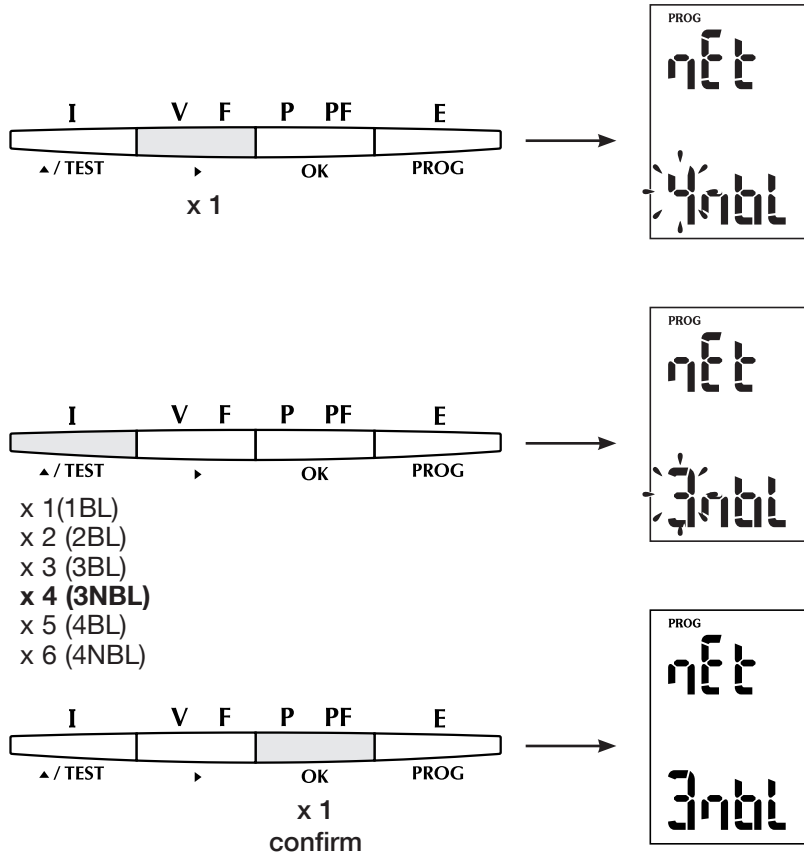

DIRIS A20

PROGRAMMING

CURRENT TRANSFORMERS (example, Ct = 1200 / 5A)

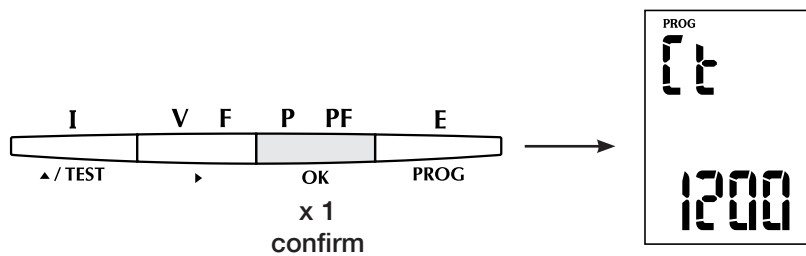
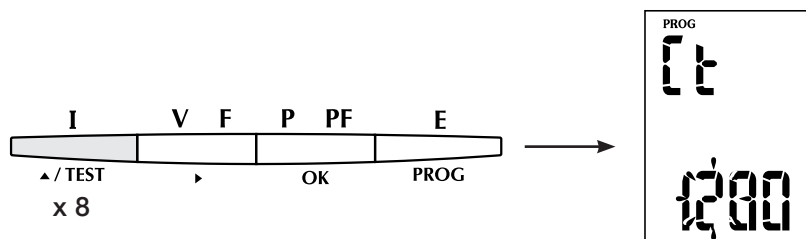
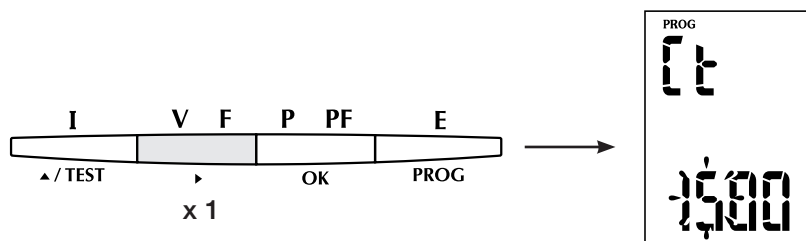
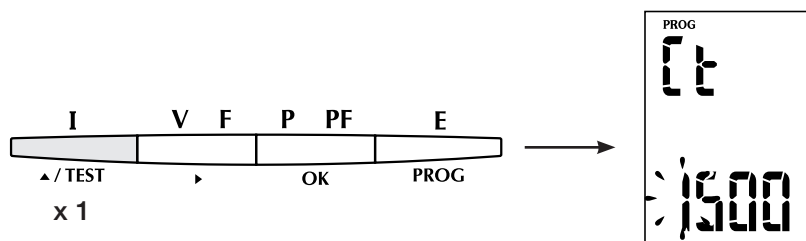
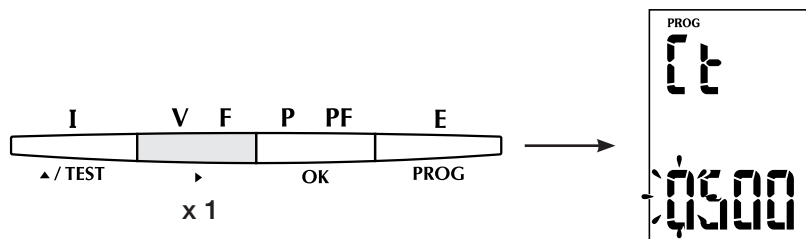

INTEGRATION TIME OF CURRENTS (example, tIME = 20 min)

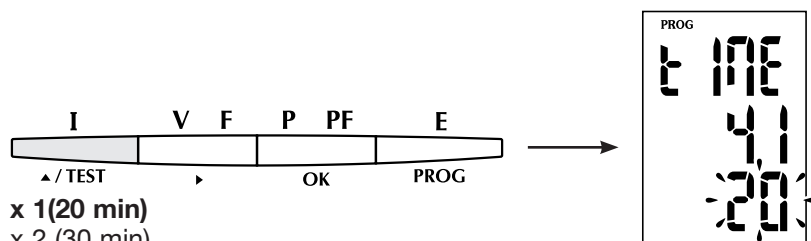
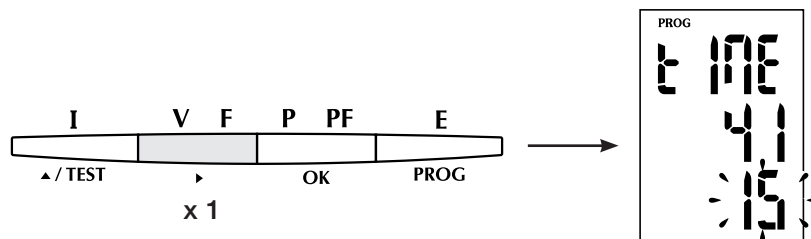

- x 1 (20 min)
- x 2 (30 min)
- x 3 (60 min)
- x 4 (2 sec)
- x 5 (5 min)
- x 6 (8 min)
- x 7 (10 min)
- x 8 (15 min)

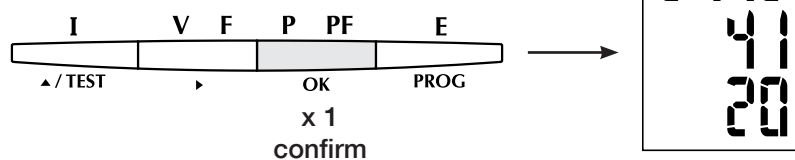

DIRIS A20

PROGRAMMING

INTEGRATION FOR ACTIVE POWER TIME (example, tIME = 20 min)

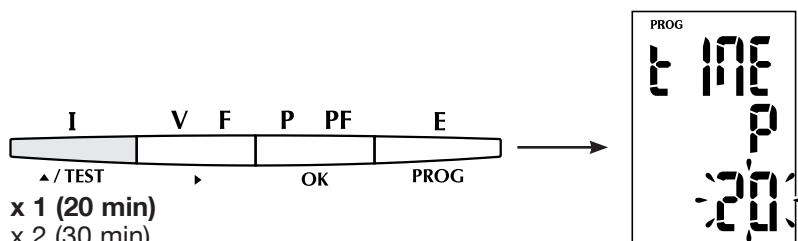
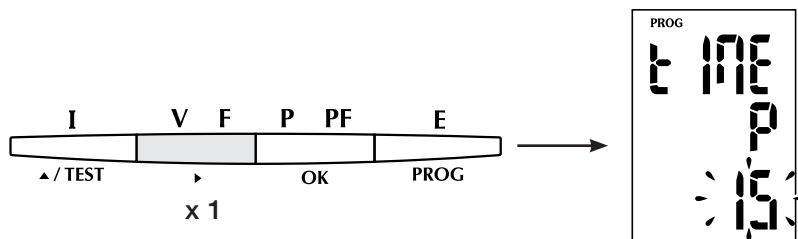

- x 1 (20 min)
- x 2 (30 min)
- x 3 (60 min)
- x 4 (2 sec)
- x 5 (5 min)
- x 6 (8 min)
- x 7 (10 min)
- x 8 (15 min)

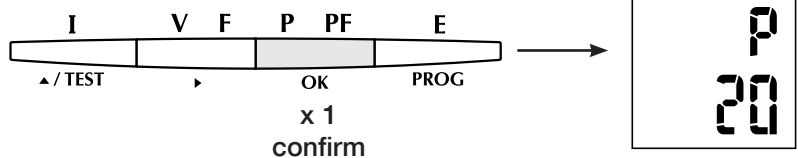

RESET TO ZERO (example, rSEt = Ea)

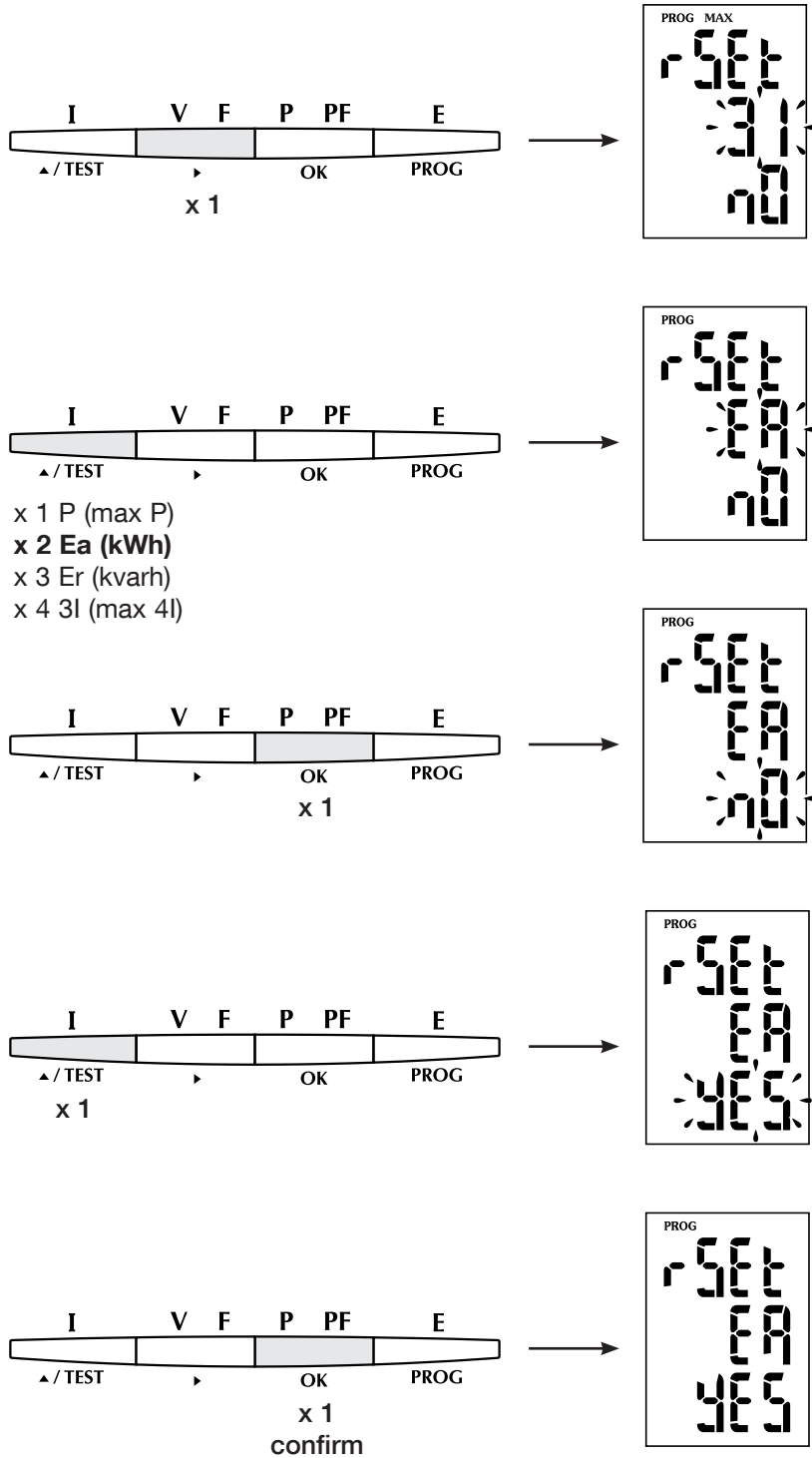

DIRIS A20

PROGRAMMING

BACKLIGHT LCD DISPLAY (example, bACLI_t = U)

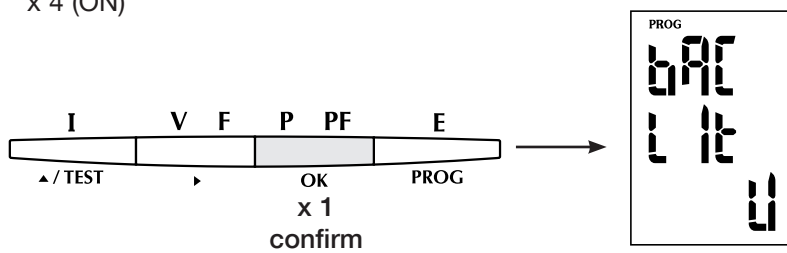
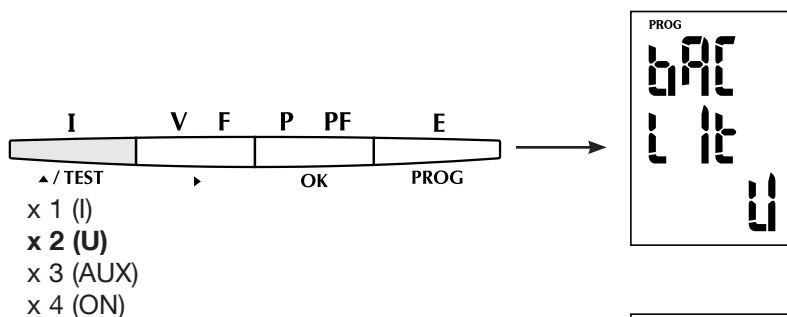
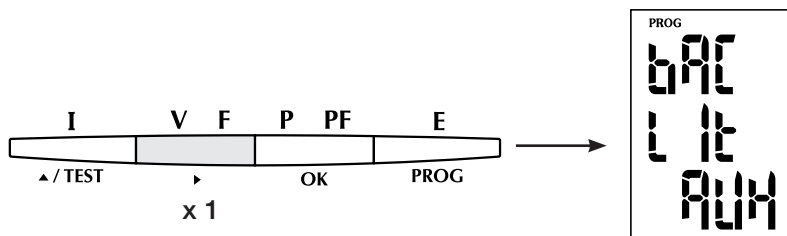

SERIAL NUMBER (example, 05312784623)

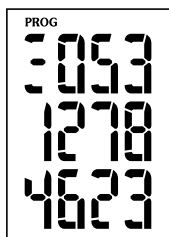

SOFTWARE VERSION



TO QUIT PROGRAMMING

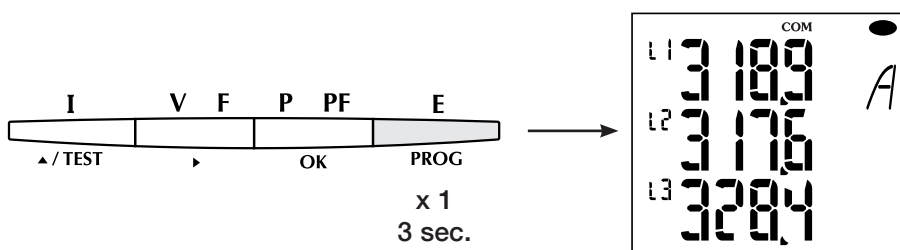

DIRIS A20

OPERATION

I - CURRENT

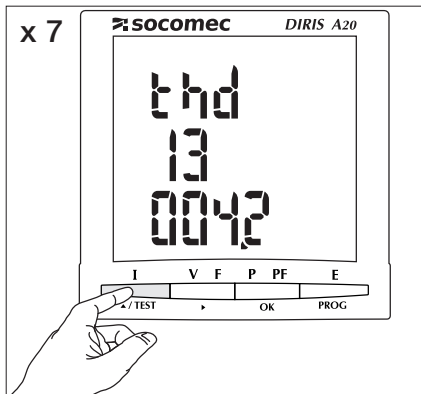
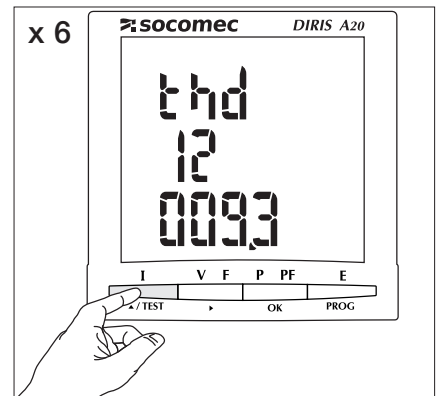
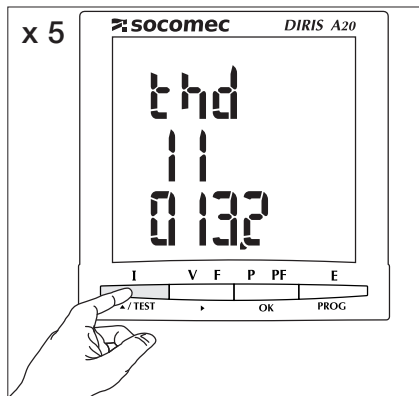
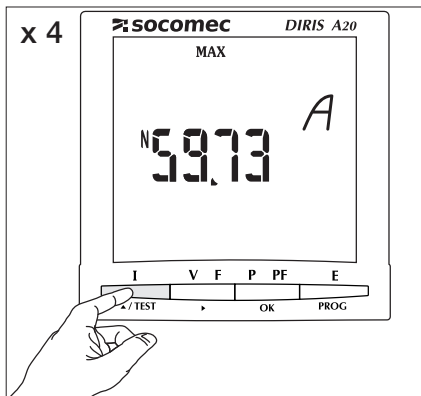
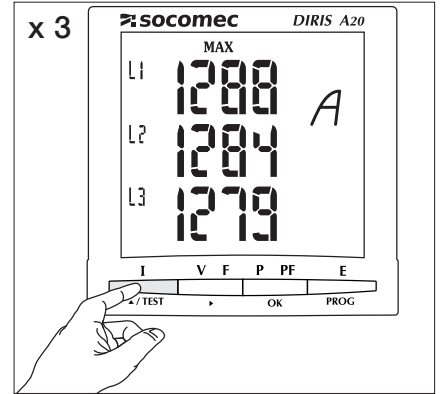
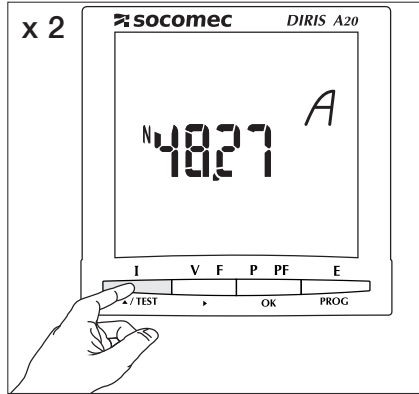
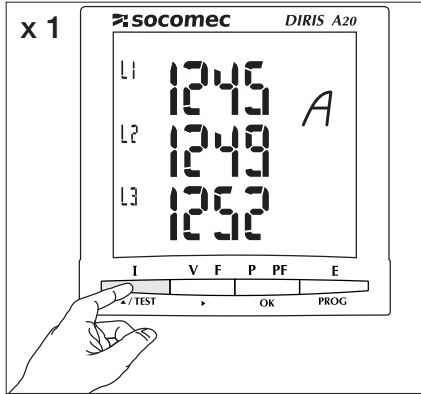

V/F - VOLTAGE/FREQUENCY

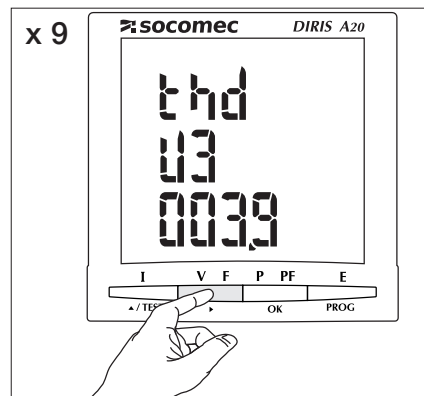
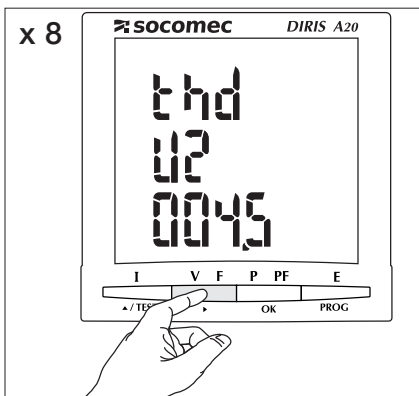
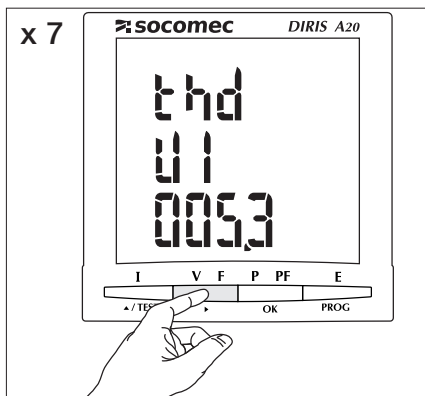
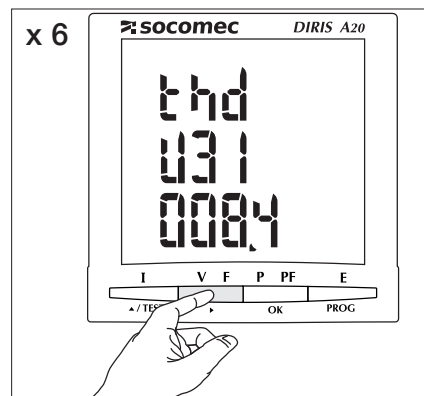
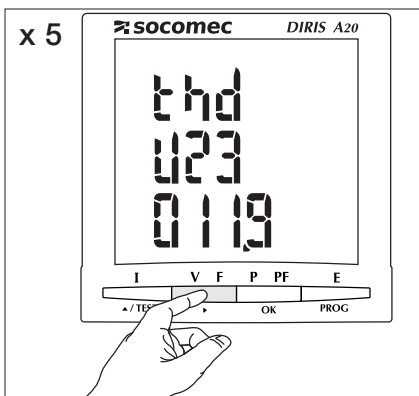
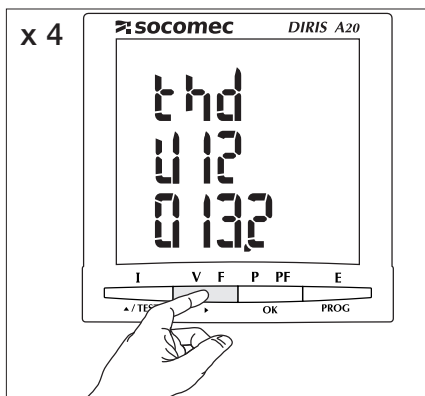
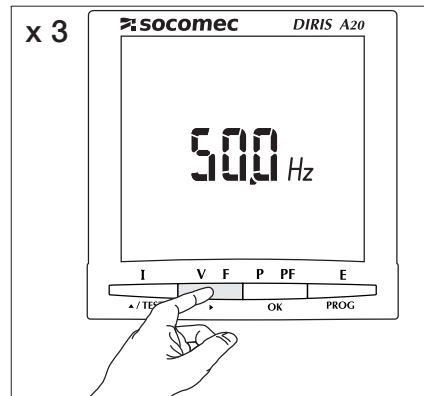
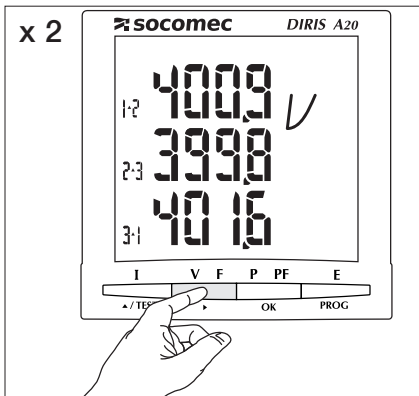
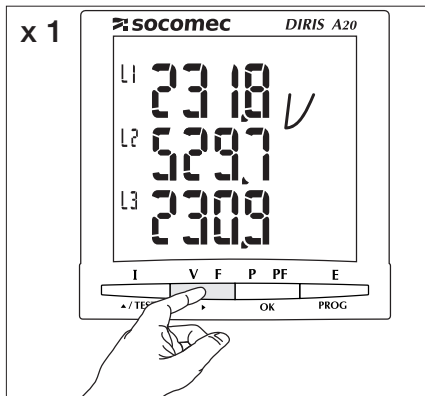

DIRIS A20

CONNECTION TEST FUNCTION

During the test, the **DIRIS** must have current and voltage for each of the phases.
 In addition to this, this function needs to have a load of at least 20% over the rated load with a power factor (PF) between 0.6 inductive $<PF < 1$.
 If these two criteria are not met, this function can not be used, and the test will not start.
 In 4BL / 3BL / 2BL / 1BL, only the CTs connection is controlled.
 In 4NBL and 3NBL, the entire connection is controlled.

Do check that these are the right conditions:

- Err 0 = no error
- Err 1 = CT phase 1 inverted
- Err 2 = CT phase 2 inverted
- Err 3 = CT phase 3 inverted
- Err 4 = V1 and V2 voltages inverted
- Err 5 = V2 and V3 voltages inverted
- Err 6 = V3 and V1 voltages inverted.

For the Err 1, Err 2 and Err 3, the modification can be performed automatically by the DIRIS or manually by correcting the current connections.

For the Err 4, Err 5 and Err 6 the modification must be performed manually by correcting the voltage connections.

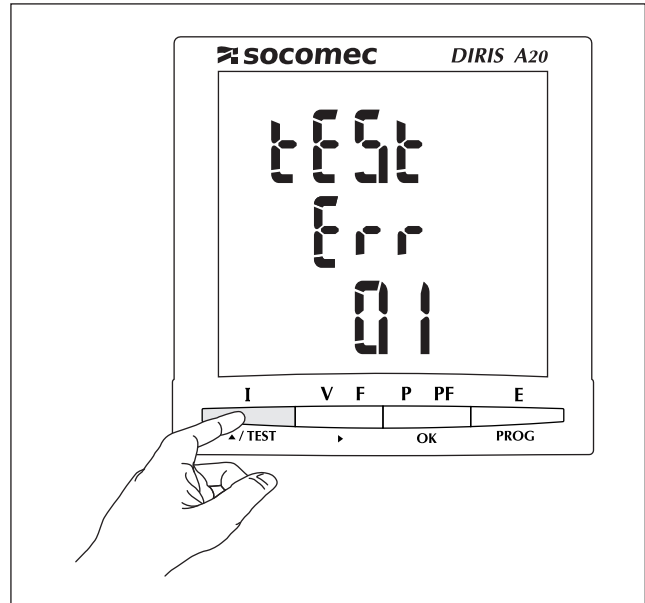

Example, tEst Err 0

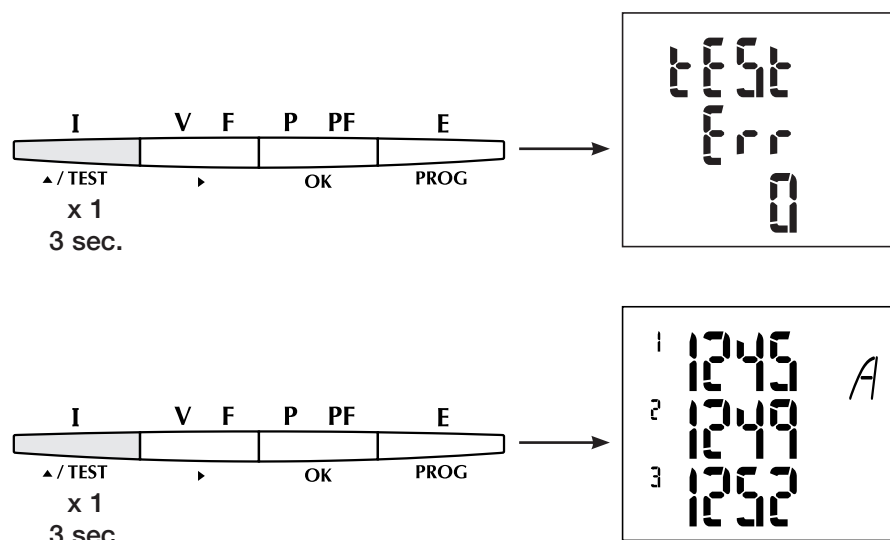

DIRIS A20

CONNECTION TEST FUNCTION

Example, tEst Err 1

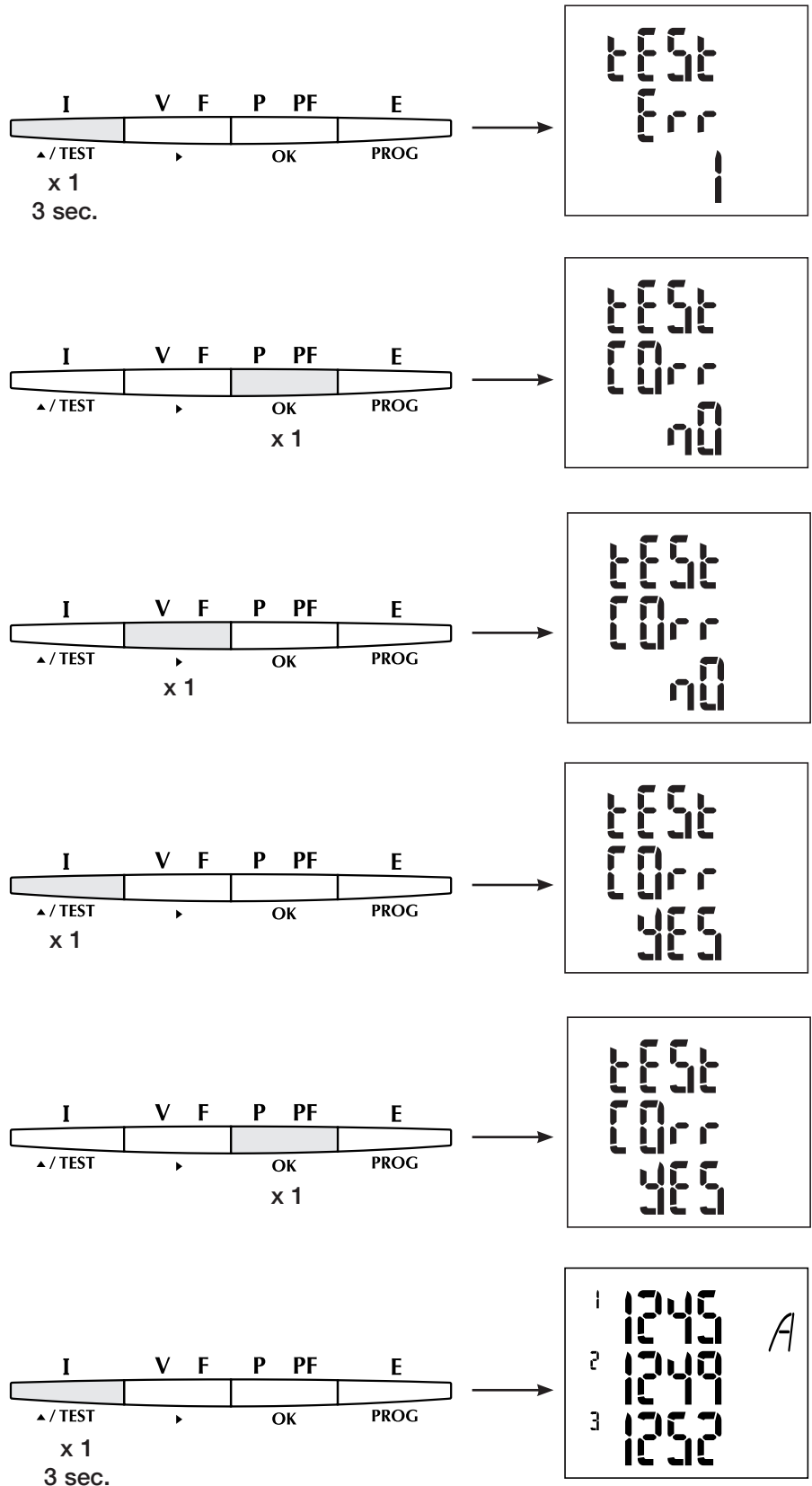

> **Second test operation**

This menu appears if the product has already been tested. This erases any changes made during the first test and retest can fully connect the product.

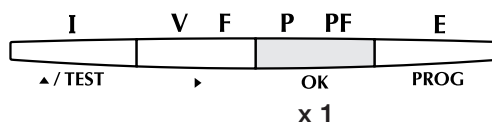
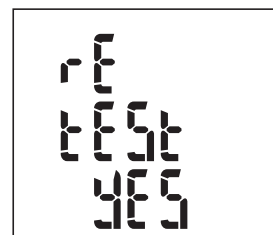
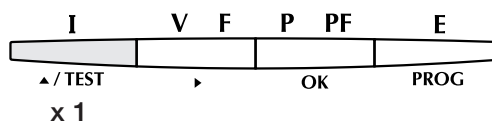
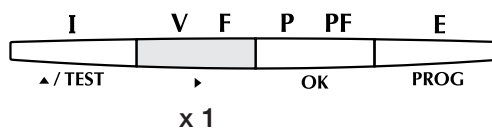
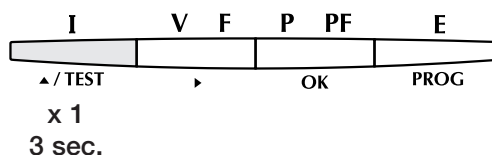

⋮
 ↓
Test operation

DIRIS A20

TECHNICAL CHARACTERISTICS

CASE

Dimensions:	96 x 96 x 60 mm or 96 x 96 x 80 mm with all optional modules (DIN 43700)
Connection:	via 2.5 mm ² disconnectable terminals (voltage and others) and 6 mm ² fixed terminals (current)
IP index:	IP52 (front panel) and IP30 (case)
Weight:	400 gr.

DISPLAY

Type :	backlit LCD display
--------	---------------------

MEASUREMENTS

Three-phase (3 or 4 wires), two-phase (2 wire) and single-phase networks

VOLTAGE (TRMS)

Direct measurement:	from 50 to 520 V AC (phase/phase) from 28 to 300 V AC (phase/neutral)
Permanent overload:	800 V AC
Update period:	1 second

CURRENT (TRMS)

Via CT with:	<ul style="list-style-type: none">• Primary: up to 9 999 A• Secondary: 5 A
Minimum measuring current	5 mA
Input consumption:	< 0.6 VA
Display:	from 0 to 11 kA (1.1 times the primary value)
Permanent overload:	6 A
Intermittent overload:	10 I _n / 1 second
Update period:	1 second

POWER

Total:	0 to 11 MW/Mvar/MVA
Update period:	1 second

FREQUENCY

	from 45,0 to 65,0 Hz
Update period:	1 second

MEASUREMENT ACCURACY

Current:	0.2 % from 10 to 110 % / I _n
Voltage:	0.2 % from 140 to 700 V AC
Power:	0.5 % of full scale (-90° à + 90°)
Power factor:	0.5 % for 0.5 < FP < 1
Frequency:	0.1 % from 45 to 65 Hz
Active energy metering:	± 0.5% from 0.02 to 1,2 I _n with PF = 0.5 L or 0.8 C (class 0.5S IEC 62053-22)
Reactive energy metering:	± 2% from 0.1 to 1,2 I _n with sinφ = 0.5 L or C (class 1 IEC 62053-23)

AUXILIARY SUPPLY IEC/CE

110 to 400 V AC 50/60 Hz	± 10 %
120 to 350 V DC	± 20 %
Consumption:	< 10 VA

ACCURACY

Accuracy on active energy:	IEC 62053-22 class 0.5S
Accuracy on reactive energy:	IEC 62053-23 class 2

CE MARKING

The **DIRIS A20** complies with:

- the requirements of the European EMC directive n°2004/108/CE dated 15.12.04;
- the European Low voltage directive n° 2006/95/CE dated 12.12.06.

ELECTROMAGNETIC COMPATIBILITY

Immunity to electrostatic discharges:	IEC 61000-4-2 - Level III
Immunity to radiated radio-frequency fields:	IEC 61000-4-3 - Level III
Immunity to electrical fast transients/bursts:	IEC 61000-4-4 - Level III
Immunity to impulse waves:	IEC 61000-4-5 - Level III
Immunity to conducted disturbances:	IEC 61000-4-6 - Level III
Immunity to power frequency magnetic fields:	IEC 61000-4-8 - Level III
Conducted and radiated emissions:	CISPR11 - Class A
Immunity to voltage dips and short interruptions:	IEC 61000-4-11

CLIMATE

Operating-temperature range:	IEC 60068-2-1/IEC 60068-2-2 -10 °C to +55°C (14° to 131°F)
Storage temperature range:	IEC 60068-2-1/IEC 60068-2-2 -20 °C to +85°C (-4° to 158°F)
Humidity:	IEC 60068-2-30 - 95 %
Saling fog:	IEC 60068-2-52 - 2,5 % NaCl

MECHANICAL CHARACTERISTICS

Vibration from 10 to 50 Hz:	IEC 60068-2-6 - 2g
-----------------------------	--------------------

INSULATION

Installation category:	III (480 VAC ph/ph)
Degree of pollution:	2
Rated impulse withstand voltage:	IEC 60947-1 - V imp: 4 kV
Front face:	Class II
Electric security:	IEC 61010-1

UL APPROVAL

Auxiliary supply	110 to 240 V AC 120 to 250 V DC
Standard	UL 61010-1 CSA-C22.2 No. 61010-1 (cULus)
Certificate	UL file No: E257746

Indoor use

Altitude up to 2000 m.

Temperature 0 to 40°C. Maximum relative humidity 80% for temperatures up to 31°C decreasing linearly to 50% relative humidity at 40°C

Transient overvoltages according to installations categories.

Overvoltage categories I,II and III.

For mains supply the minimum and normam category is II.

DIRIS A20

ASSISTANCE

-
- **Device switched off**
Check auxiliary supply.
 - **Backlight switched off**
Check backlight configuration in set up menu (p. 16).
 - **Voltage = 0**
Verify the connections.
 - **Current = 0 or incorrect**
Verify the connections.
Verify the configuration of CT's in set up.
 - **Powers and power-factor (PF)**
Use the test connection function (p. 21).
 - **Phases missing on display**
Check the network configuration (p. 11).

GLOSSARY OF ABBREVIATIONS

nEt	Network type
4NBL	Unbalanced three-phase network, 4 wires with 3 or 4 CT
4BL	Balanced three-phase network, 4 wires with 1 CT
3NBL	Unbalanced three-phase network, 3 wires with 2 or 3 CT
3BL	Balanced three-phase network, 3 wires with 1 CT
2BL	Two-phase network, 2 wires with 1 CT
1BL	Single-phase network, 2 wires with 1 CT
Ct	Current transformers
MAX	Maximum mean value
time I1	Integration times for maximum current values
time P	Integration times for maximum power values
rSET	Reset
MAX P	Active power maximum mean value
EA	Active energy (kWh)
ER	Reactive energy (kvarh)
AUX	Auxiliary supply
bACLI	LCD start-up (U or I or AUX or ON condition)
≡	Serial number
SOFT	Software version
THD I1, I2, I3	Current harmonic distortion rate
THD U12, U23, U31	Phase-to-phase voltage distortion rate
THD V1, V2, V3	Phase-to-neutral voltage distortion rate

DANGER ET AVERTISSEMENT	29
OPERATIONS PREALABLES	29
PRESENTATION.....	29
INSTALLATION.....	30
PROGRAMMATION.....	35
UTILISATION	44
FONCTION DE TEST DU RACCORDEMENT	47
CARACTERISTIQUES TECHNIQUES	50
ASSISTANCE	52
LEXIQUE DES ABREVIATIONS.....	52

DIRIS A20

DANGER ET AVERTISSEMENT

Le montage de ces matériels ne peut être effectué que par des professionnels.

Le non respect des indications de la présente notice ne saurait engager la responsabilité du constructeur.

Risque d'électrocution, de brûlures ou d'explosion

- L'installation et l'entretien de cet appareil ne doivent être effectués que par du personnel qualifié.
- Avant toute intervention sur l'appareil, couper les entrées tensions, court-circuitez le secondaire de chaque transformateur de courant (PTI SOCOMEC) et coupez l'alimentation auxiliaire de l'appareil.
- Utilisez toujours un dispositif de détection de tension approprié pour confirmer l'absence de tension.
- Remplacez tous les dispositifs, les portes et les couvercles avant de mettre cet appareil sous tension.
- Utilisez toujours la tension assignée appropriée pour alimenter cet appareil.

Si ces précautions n'étaient pas respectées, cela pourrait entraîner des blessures graves.

Risque de détérioration de l'appareil

Veillez à respecter :

- La plage de tension d'alimentation auxiliaire.
- La fréquence du réseau 50 ou 60 Hz.
- Une tension maximum aux bornes des entrées tension de 520 V AC phase/phase ou 300 V AC phase/neutre.
- Un courant maximum de 6 A aux bornes des entrées courants (I1, I2 et I3).

OPÉRATIONS PRÉALABLES

Pour la sécurité du personnel et du matériel, il est impératif de bien s'imprégner du contenu de cette notice avant la mise en service.

Au moment de la réception du colis contenant le **DIRIS A20**, il est nécessaire de vérifier les points suivants :

- l'état de l'emballage,
- le produit n'a pas eu de dommage pendant le transport,
- la référence de l'appareil est conforme à votre commande,
- l'emballage comprend le produit équipé d'un bornier débrochable,
- une notice d'utilisation.

PRÉSENTATION

Les **DIRIS A20** sont des centrales de mesures qui mettent à disposition de l'utilisateur, toutes les mesures nécessaires pour mener à bien les projets d'efficacité énergétique et assurer la surveillance de la distribution électrique.

1. Clavier 4 touches pour visualiser l'ensemble des mesures et modifier les paramètres de configuration
2. Afficheur LCD rétroéclairé
3. Phase
4. Valeurs
5. Unité
6. Indicateur d'activité sur les bus de communication
7. Indicateur de comptage de l'énergie active



DIRIS A20

INSTALLATION

RECOMMANDATIONS

- Éviter la proximité avec des systèmes générateurs de perturbations électromagnétiques.
- Éviter les vibrations comportant des accélérations supérieures à 1 g pour des fréquences inférieures à 60 Hz.

PLAN DE DÉCOUPE

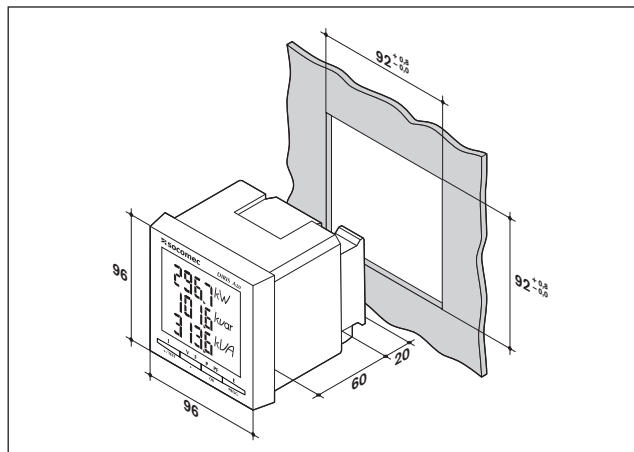

MONTAGE

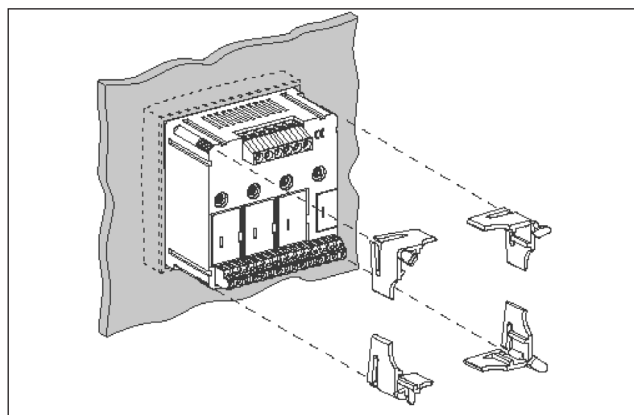

DIRIS A20

INSTALLATION

RACCORDEMENT

Le couple de serrage maximum de chaque vis est de 0,4 Nm.

Lors d'une déconnexion du **DIRIS**, il est indispensable de court-circuiter les secondaires de chaque transformateur de courant. Cette manipulation peut se faire automatiquement à partir d'un produit du catalogue SOCOMEC : le PTI. Pour plus d'informations sur ce produit, merci de nous consulter.

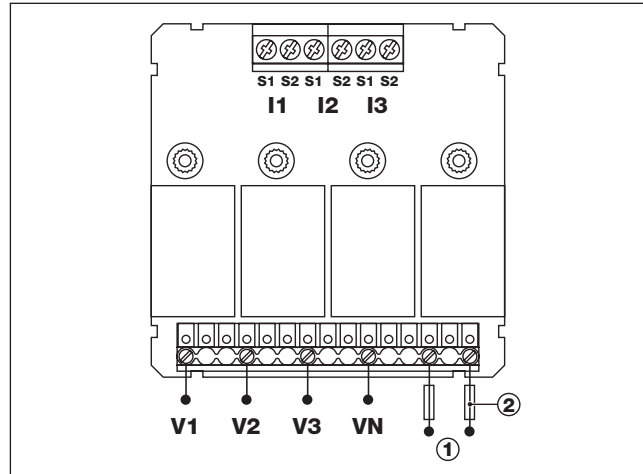

① Aux.:	IEC/CE	110... 400V AC 120... 350V DC
	UL	110... 240V AC 120... 250V DC

② Fus.: 0.5 A gG / BS 88 2A gG / 0.5 A class CC

MODUL ES OPTIONS

Les **DIRIS A20** peuvent être équipés de modules options :

- **Communication JBUS/MODBUS (réf : 48250082)**
Liaison série RS485 JBUS/MODBUS en mode RTU avec une vitesse de 2400 à 38400 bauds. (Notice d'utilisation réf : 536085).
- **Sortie impulsion (réf. 48250080)**
1 sortie qui peut être affectée en mode :
 - impulsionnelle : associé aux comptages des énergies kWh et kvarh ;
 - alarme : pour la surveillance des grandeurs électriques ;
 - commande : pour le pilotage à distance d'organe de coupure ou de commande. (Notice d'utilisation réf : 536037).

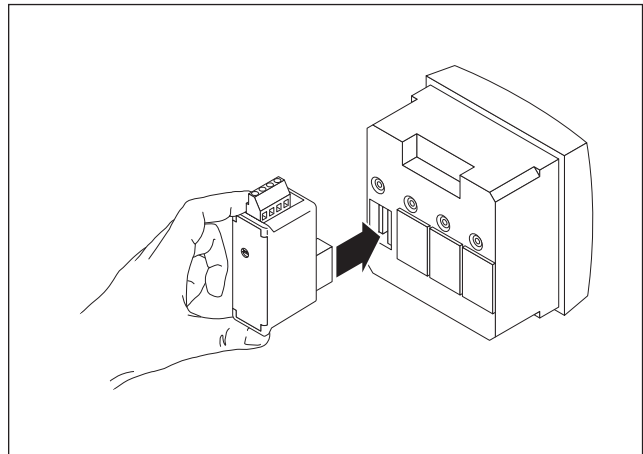

DIRIS A20

INSTALLATION

RÉSEAU TRIPHASÉ DÉSÉQUILIBRÉ (3NBL / 4NBL)

La solution avec 2 TC diminue de 0,5 % la précision de la phase dont le courant est déduit par calcul vectoriel.



En régime IT, ne pas raccorder les secondaires de TC à la terre.

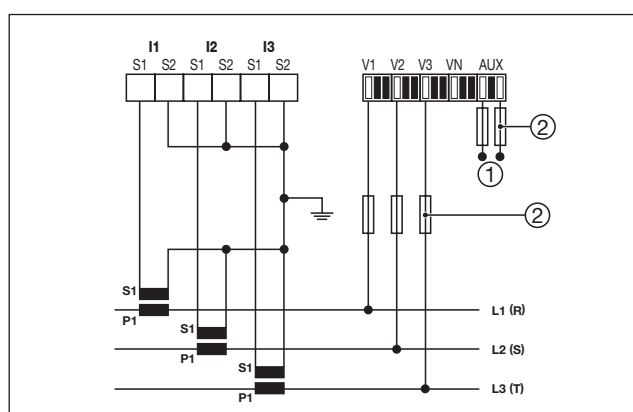
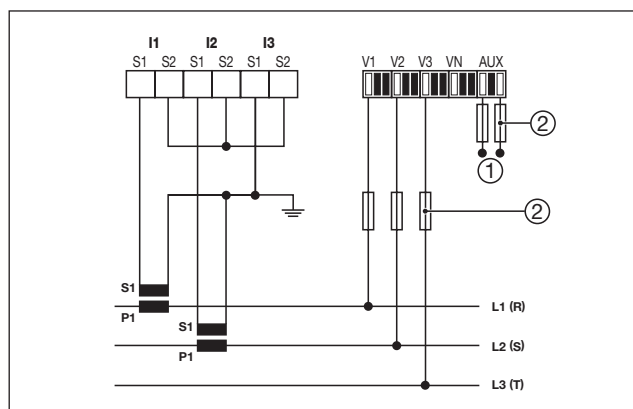
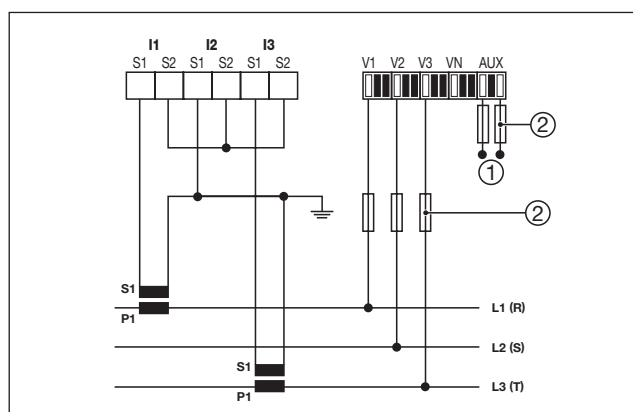
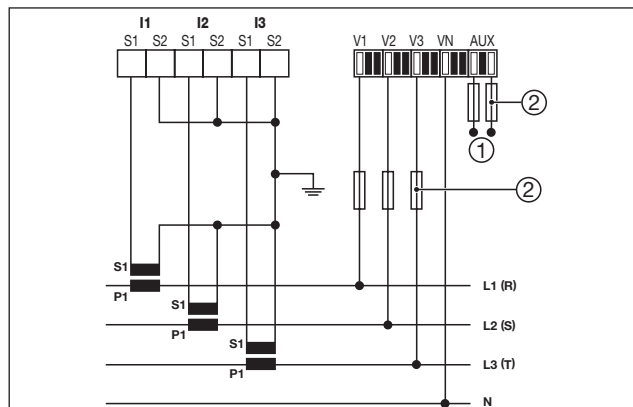

① Aux.: CEI/CE 110... 400V AC
120... 350V DC

UL 110... 240V AC
120... 250V DC

② Fus.: 0.5 A gG / BS 88 2A gG / 0.5 A class CC

RÉSEAU TRIPHASÉ ÉQUILIBRÉ (3BL/4BL)

La solution avec 1 TC diminue de 0,5 % la précision des phases dont le courant est déduit par calcul vectoriel.



En régime IT, ne pas raccorder les secondaires de TC à la terre.

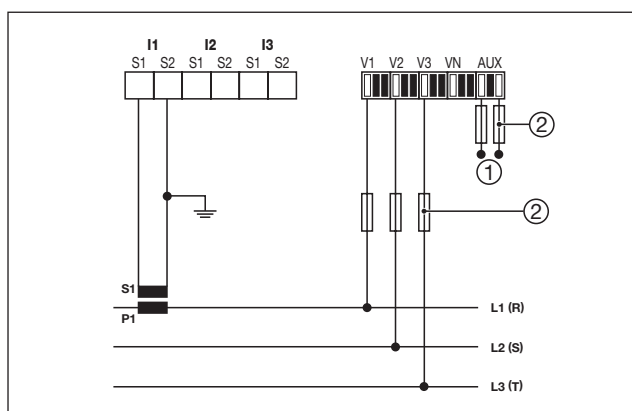
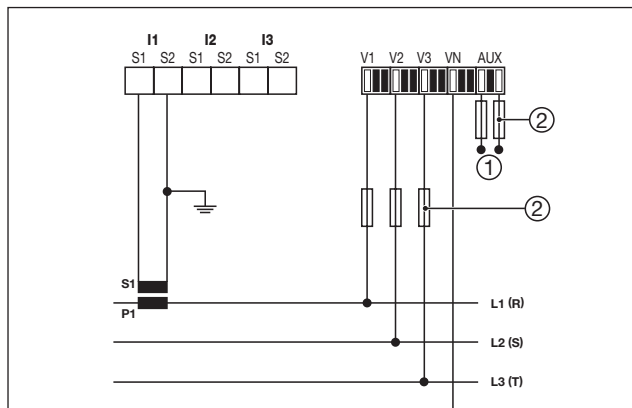

① Aux.: CEI/CE 110... 400V AC
120... 350V DC

UL 110... 240V AC
120... 250V DC

② Fus.: 0.5 A gG / BS 88 2A gG / 0.5 A class CC

DIRIS A20

INSTALLATION

RÉSEAU BIPHASÉ (2BL)



En régime IT, ne pas raccorder les secondaires de TC à la terre.

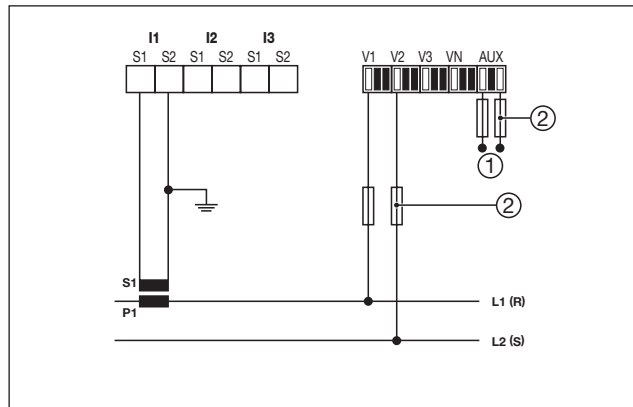

① Aux.: CEI/CE 110... 400V AC
120... 350V DC

UL 110... 240V AC
120... 250V DC

② Fus.: 0.5 A gG / BS 88 2A gG / 0.5 A class CC

RÉSEAU MONOPHASÉ (1BL)



En régime IT, ne pas raccorder les secondaires de TC à la terre.

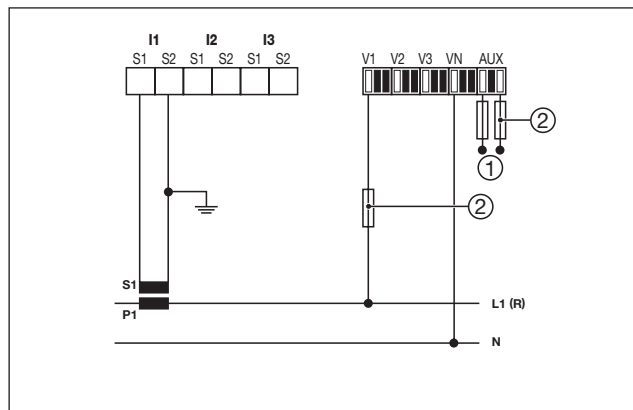

① Aux.: CEI/CE 110... 400V AC
120... 350V DC

UL 110... 240V AC
120... 250V DC

② Fus.: 0.5 A gG / BS 88 2A gG / 0.5 A class CC

MENU PROGRAMMATION

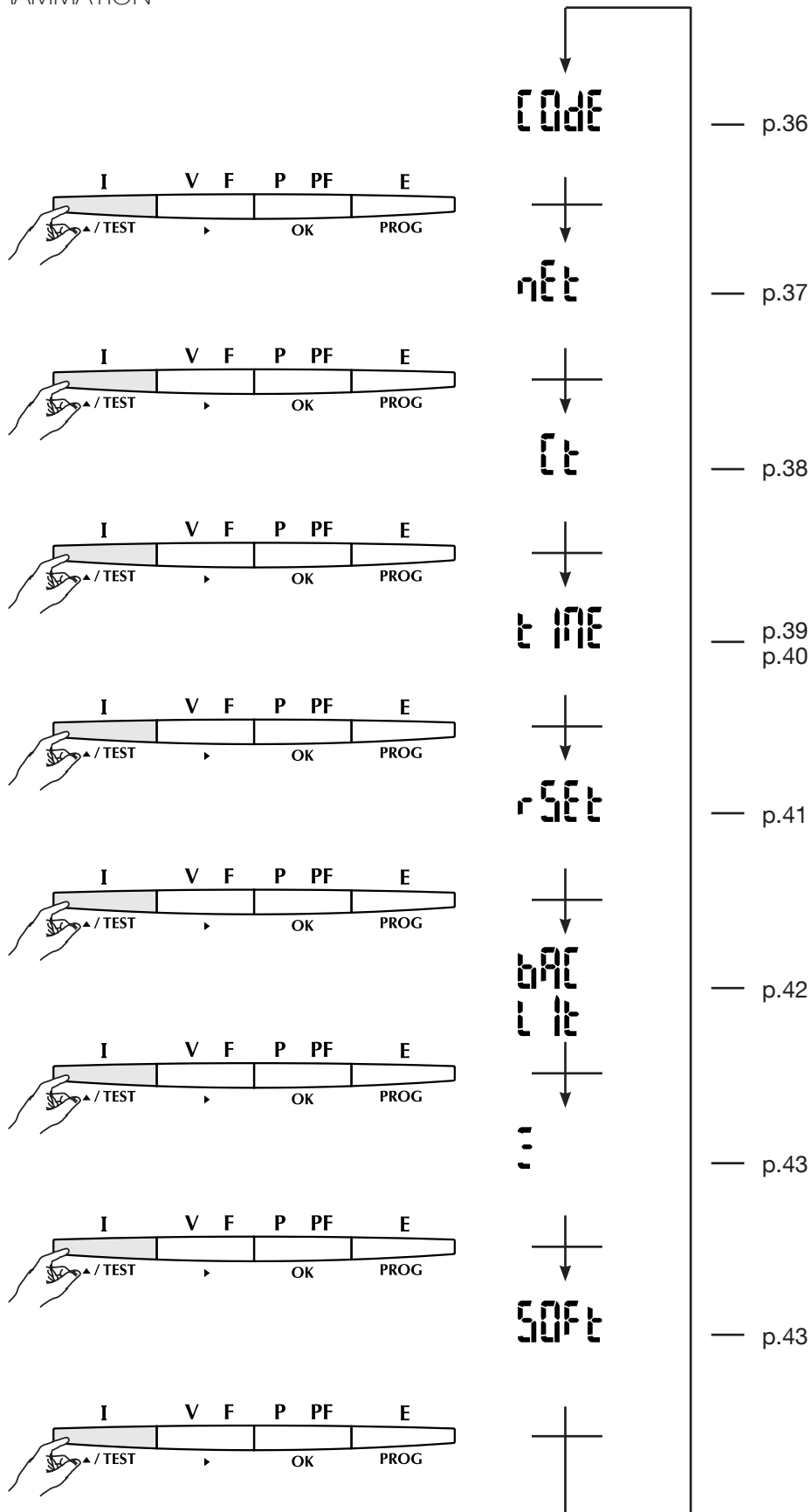

F

DIRIS A20

PROGRAMMATION

ENTRER EN PROGRAMMATION (exemple, COde = 100)

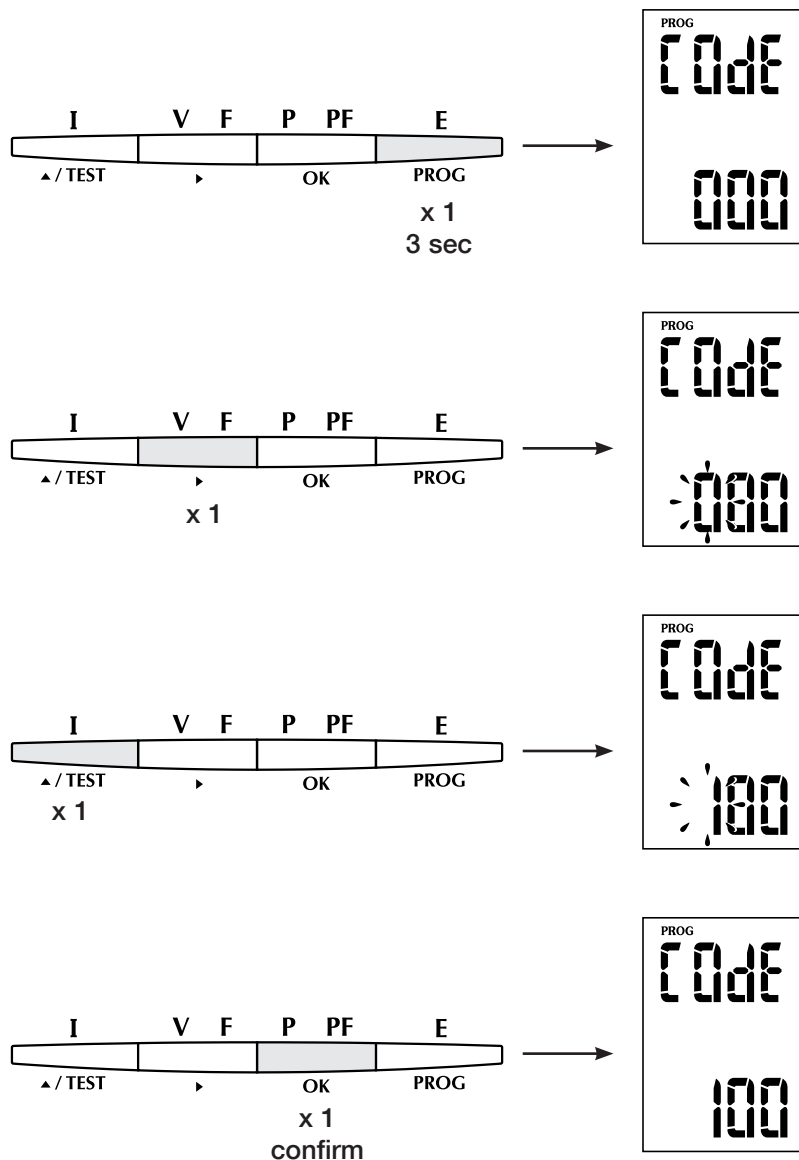

RÉSEAU (exemple, nEt = 3nbl)

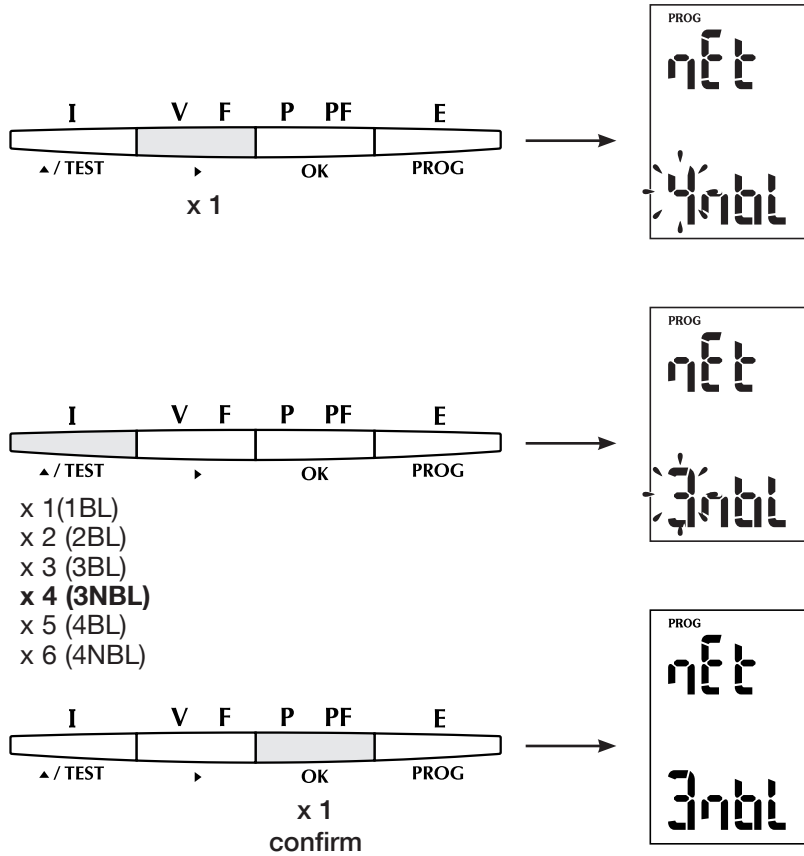

F

DIRIS A20

PROGRAMMATION

TRANSFORMATEURS DE COURANT (exemple, Ct = 1200 / 5A)

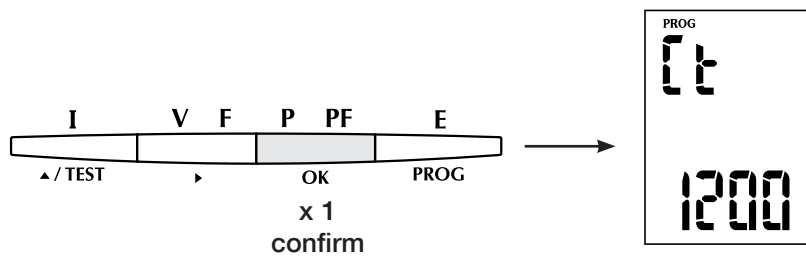
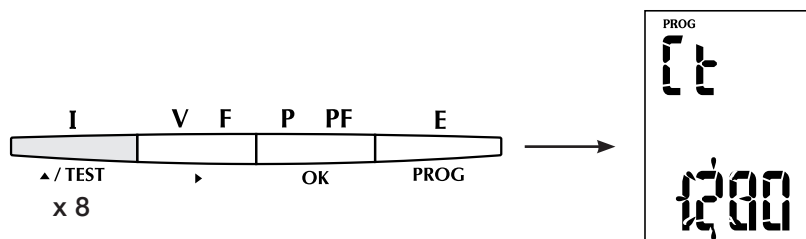
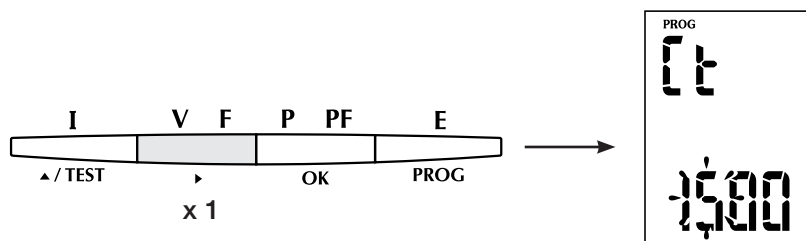
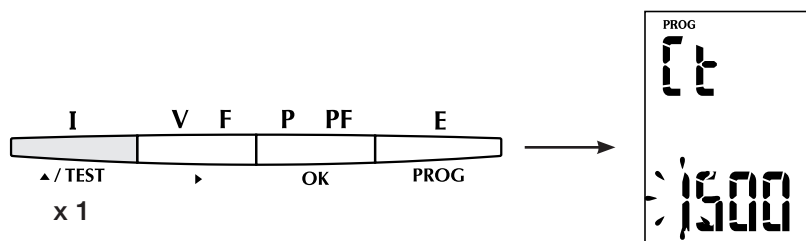
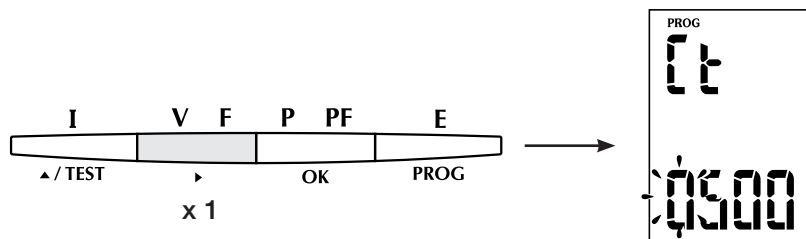

INTÉGRATION DES COURANTS (exemple, tIME = 20 min)

F

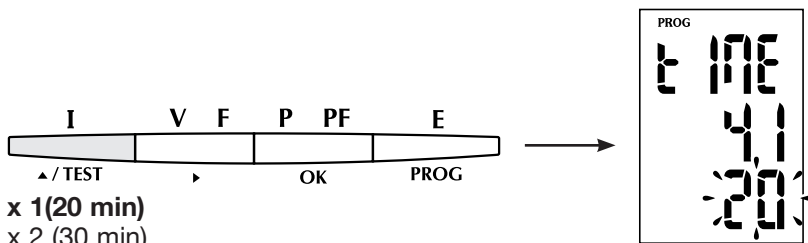
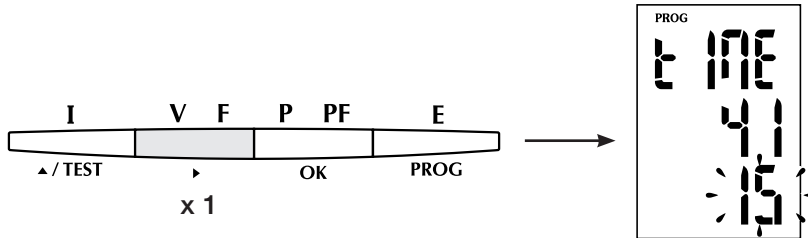

- x 1(20 min)
- x 2 (30 min)
- x 3 (60 min)
- x 4 (2 sec)
- x 5 (5 min)
- x 6 (8 min)
- x 7 (10 min)
- x 8 (15 min)

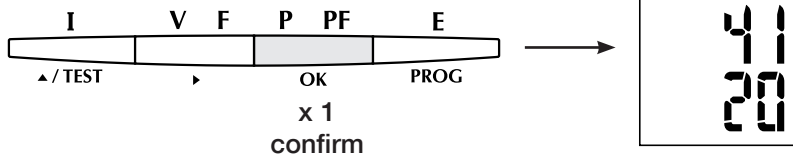

DIRIS A20

PROGRAMMATION

INTÉGRATION DE LA PUISSANCE ACTIVE (exemple, tIME = 20 min)

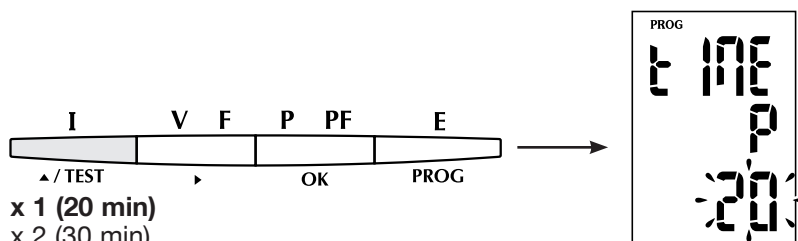
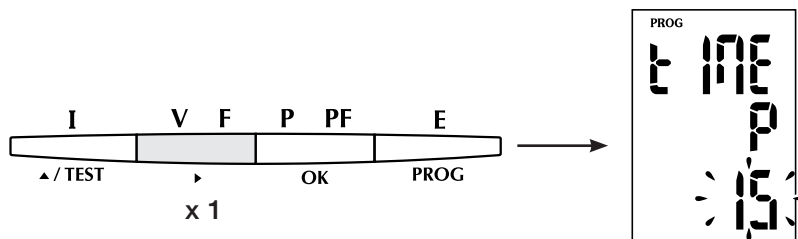

- x 1 (20 min)
- x 2 (30 min)
- x 3 (60 min)
- x 4 (2 sec)
- x 5 (5 min)
- x 6 (8 min)
- x 7 (10 min)
- x 8 (15 min)

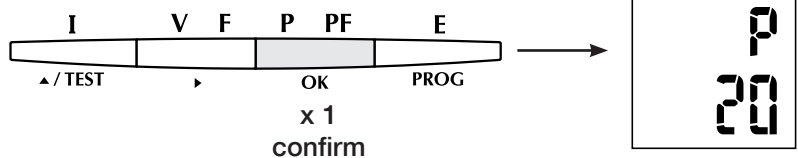

REMISE À ZÉRO (exemple, rSEt = Ea)

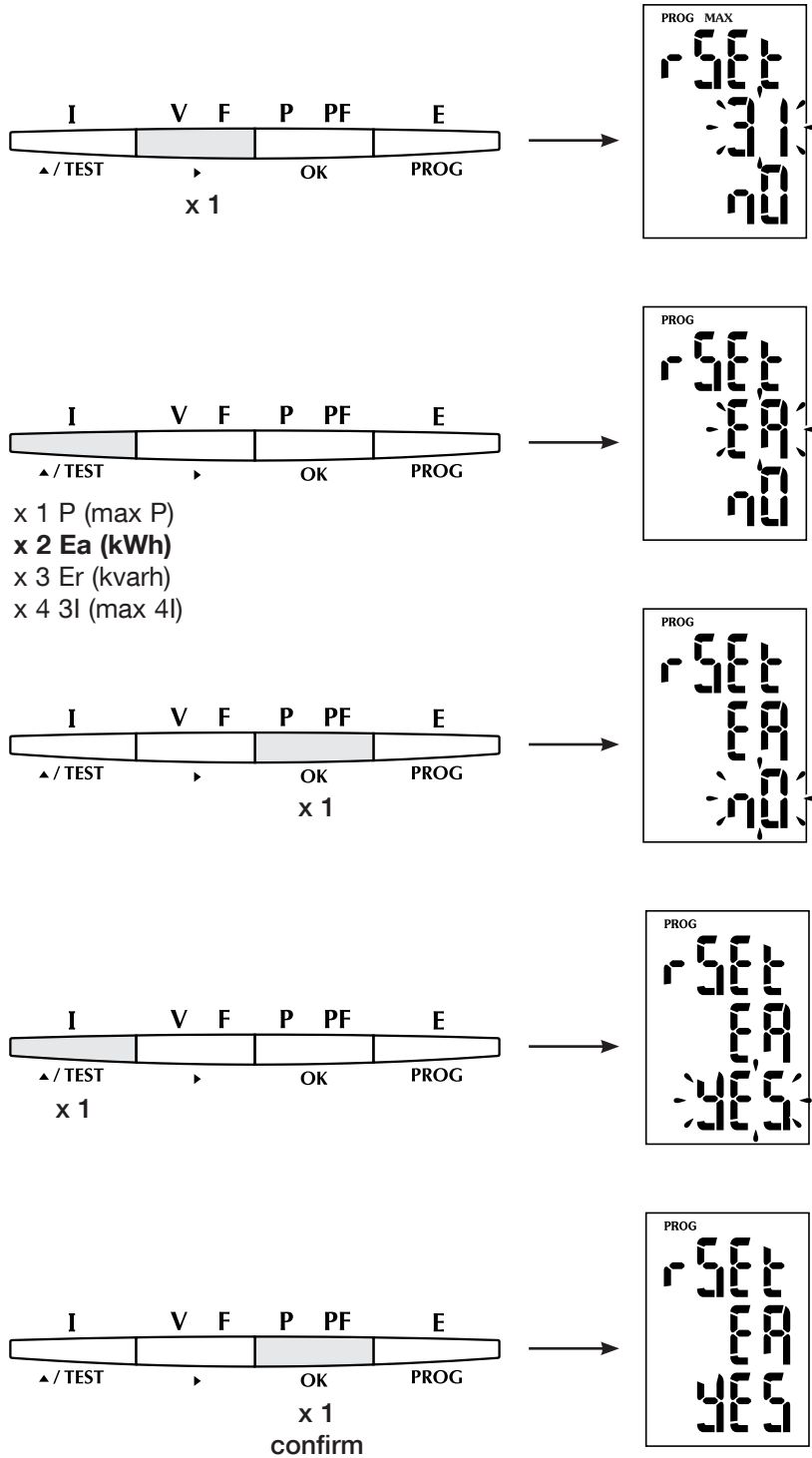

F

DIRIS A20

PROGRAMMATION

RÉTROÉCLAIRAGE (exemple, bACLIt = U)

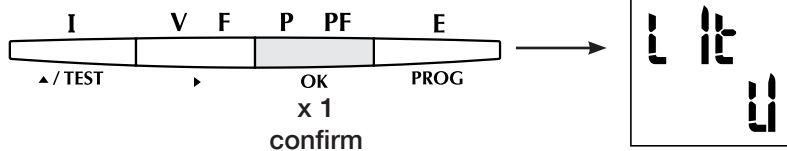
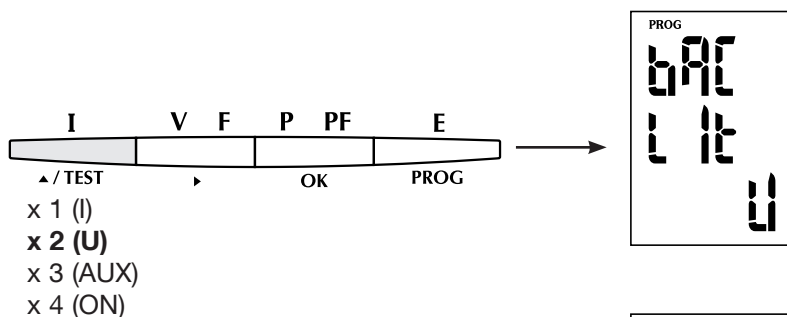
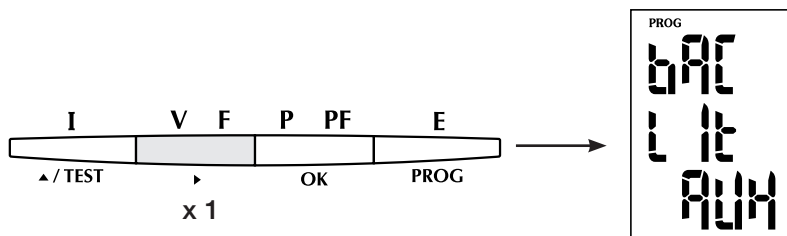

NUMÉRO DE SÉRIE (exemple, 05312784623)

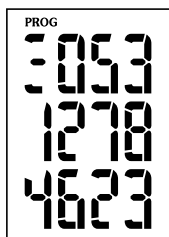

F

VERSION LOGICIEL



QUITTER LA PROGRAMMATION

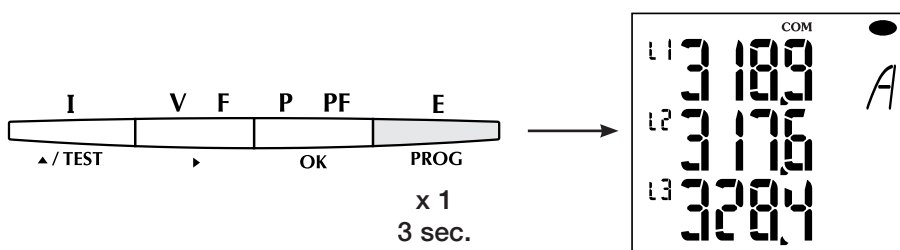

DIRIS A20

UTILISATION

I - CURRENT

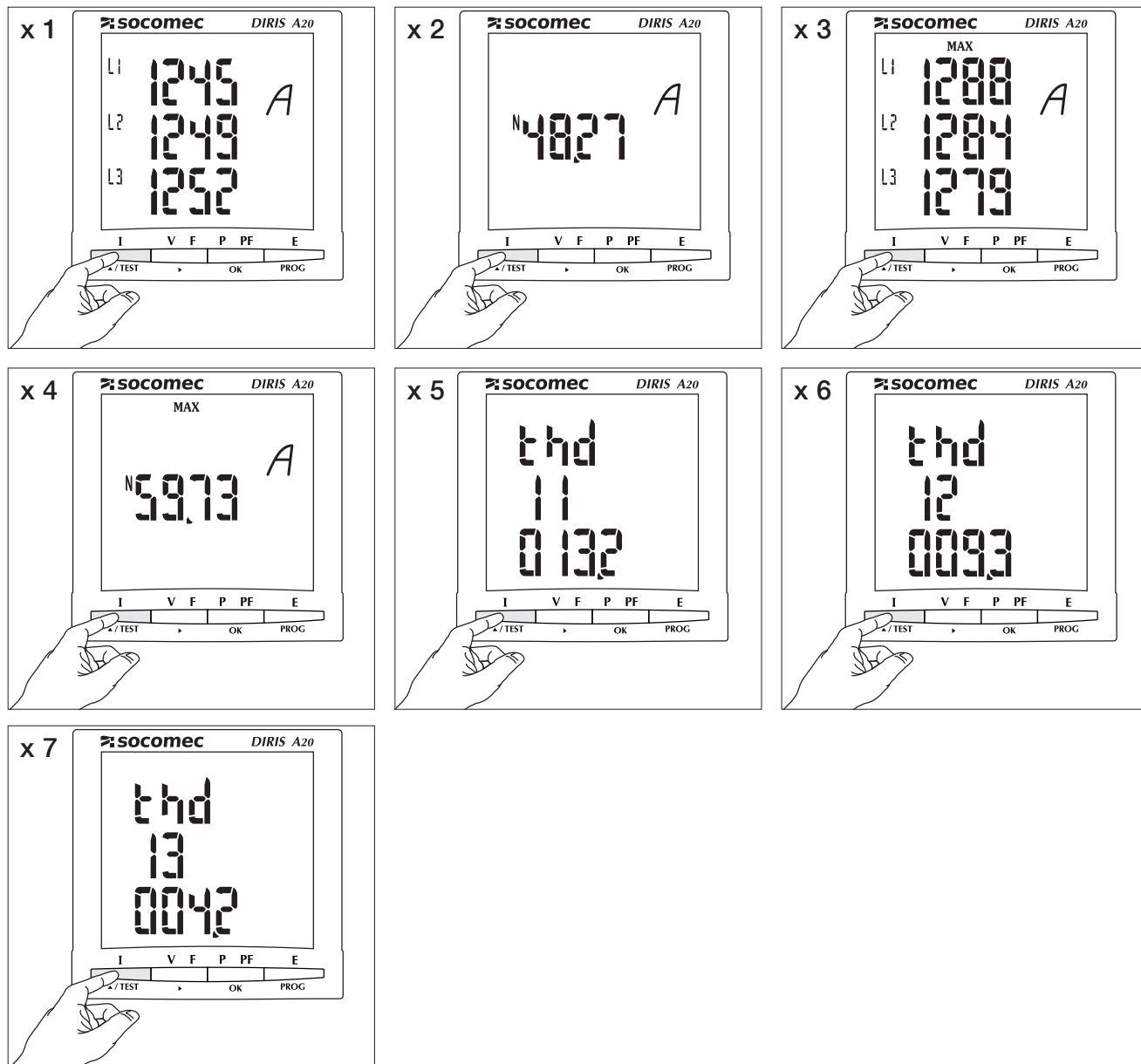

V/F - VOLTAGE/FREQUENCY

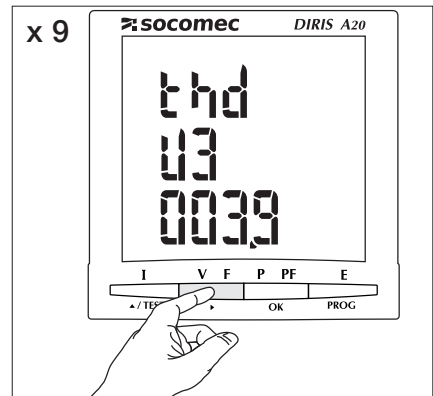
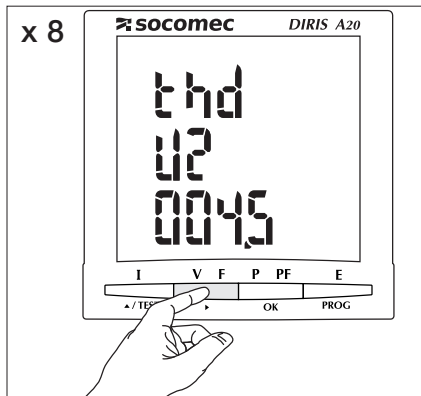
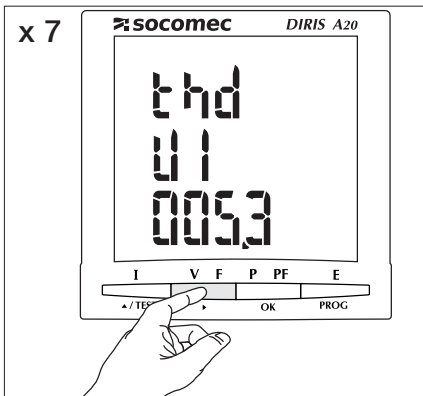
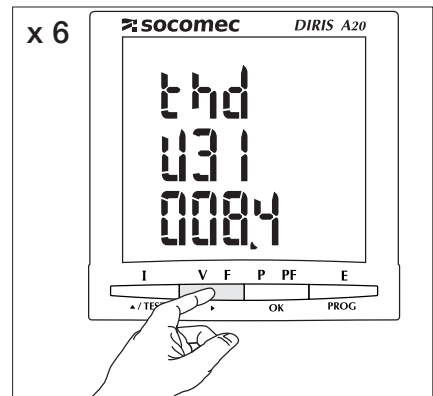
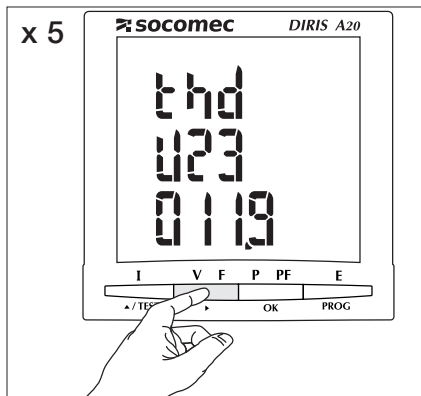
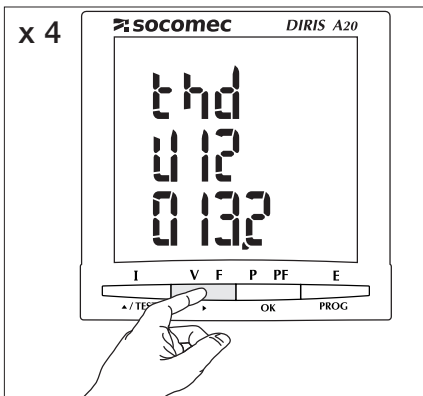
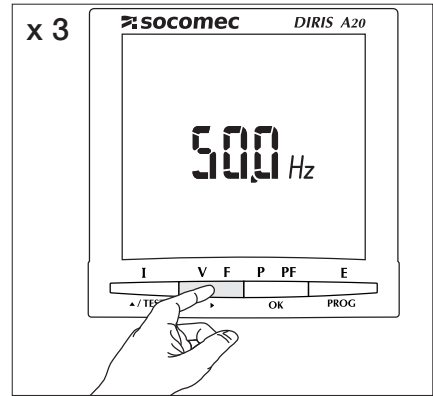
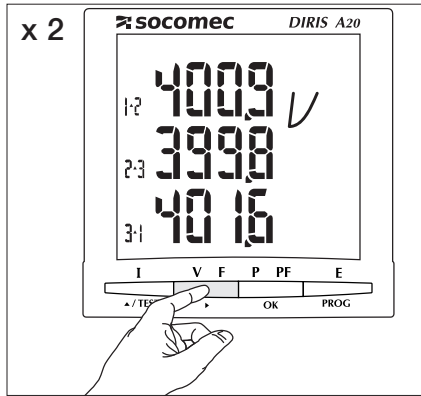
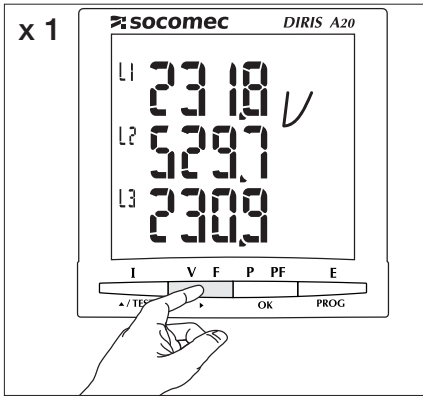

F

DIRIS A20

UTILISATION

P/PF - POWER/POWER FACTORY



E - ENERGY

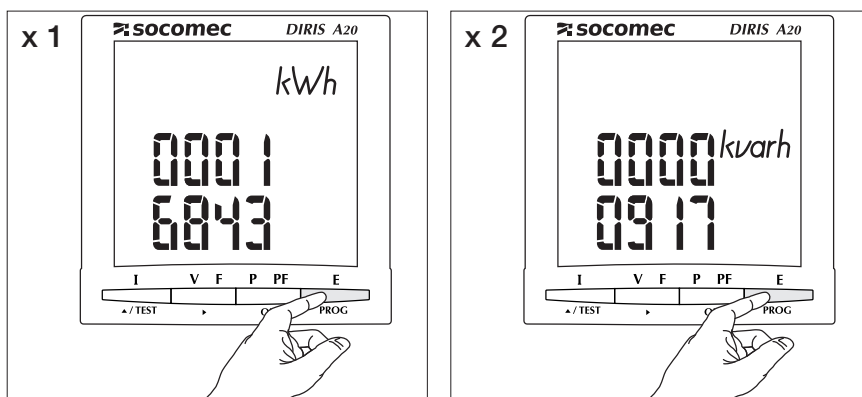

DIRIS A20

FONCTION DE TEST DU RACCORDEMENT

Lors du test, le **DIRIS** doit avoir du courant et de la tension sur chacune des phases.

De plus, cette fonction nécessite d'avoir une charge d'au moins 20% par rapport à la charge nominale, avec un facteur de puissance (FP) inductif compris entre $0,6 < FP < 1$.

Si ces deux critères ne sont pas respectés, cette fonction ne peut pas être utilisée, et le test ne démarra pas.

En 4BL / 3BL / 2BL / 1BL, seul le raccordement des TC est contrôlé.

En 4NBL et 3NBL, l'ensemble du raccordement est contrôlé.

Liste des erreurs affichées :

Err 0 = aucune erreur

Err 1 = inversion du raccordement du TC sur la phase 1

Err 2 = inversion du raccordement du TC sur la phase 2

Err 3 = inversion du raccordement du TC sur la phase 3

Err 4 = inversion en tension entre V1 et V2

Err 5 = inversion en tension entre V2 et V3

Err 6 = inversion en tension entre V3 et V1.

Pour les Err 1, Err 2 et Err 3, la modification peut se faire automatiquement via le DIRIS ou manuellement en corrigeant le raccordement des courants.

Pour les Err 4, Err5 et Err 6 la modification doit se faire manuellement en corrigeant le raccordement des tensions.

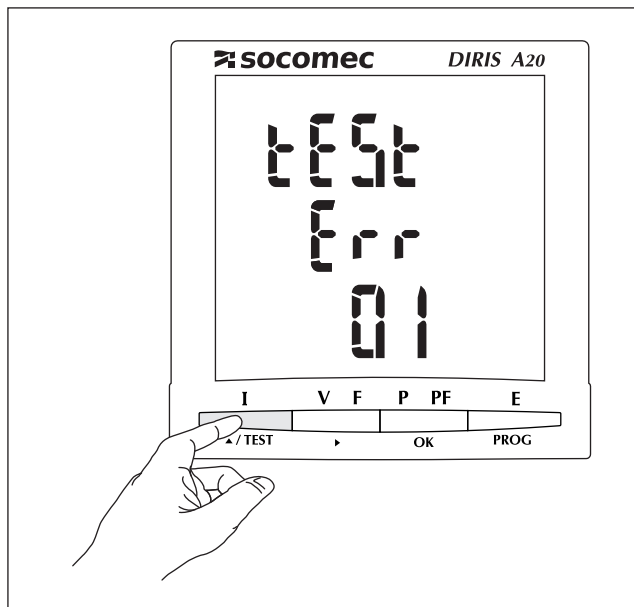

Exemple, tEST Err 0

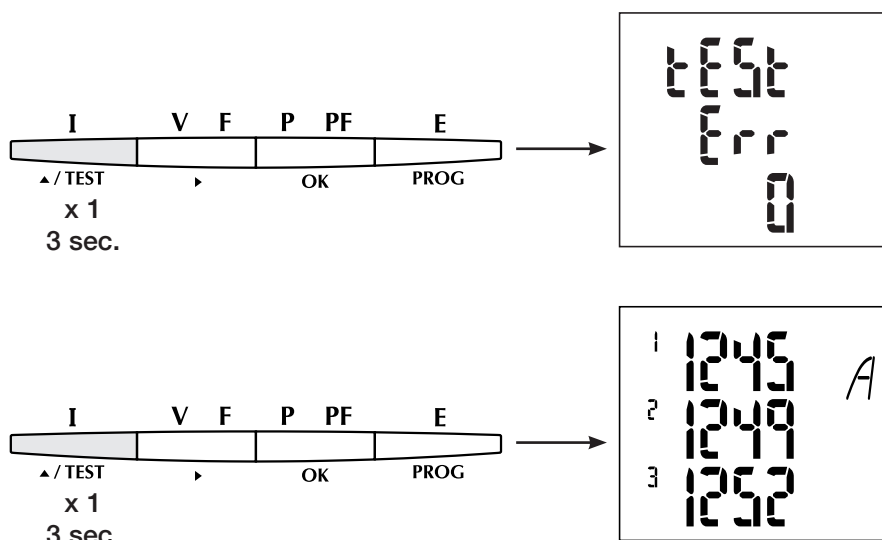

DIRIS A20

FONCTION DE TEST DU RACCORDEMENT

Exemple, tEst Err 1

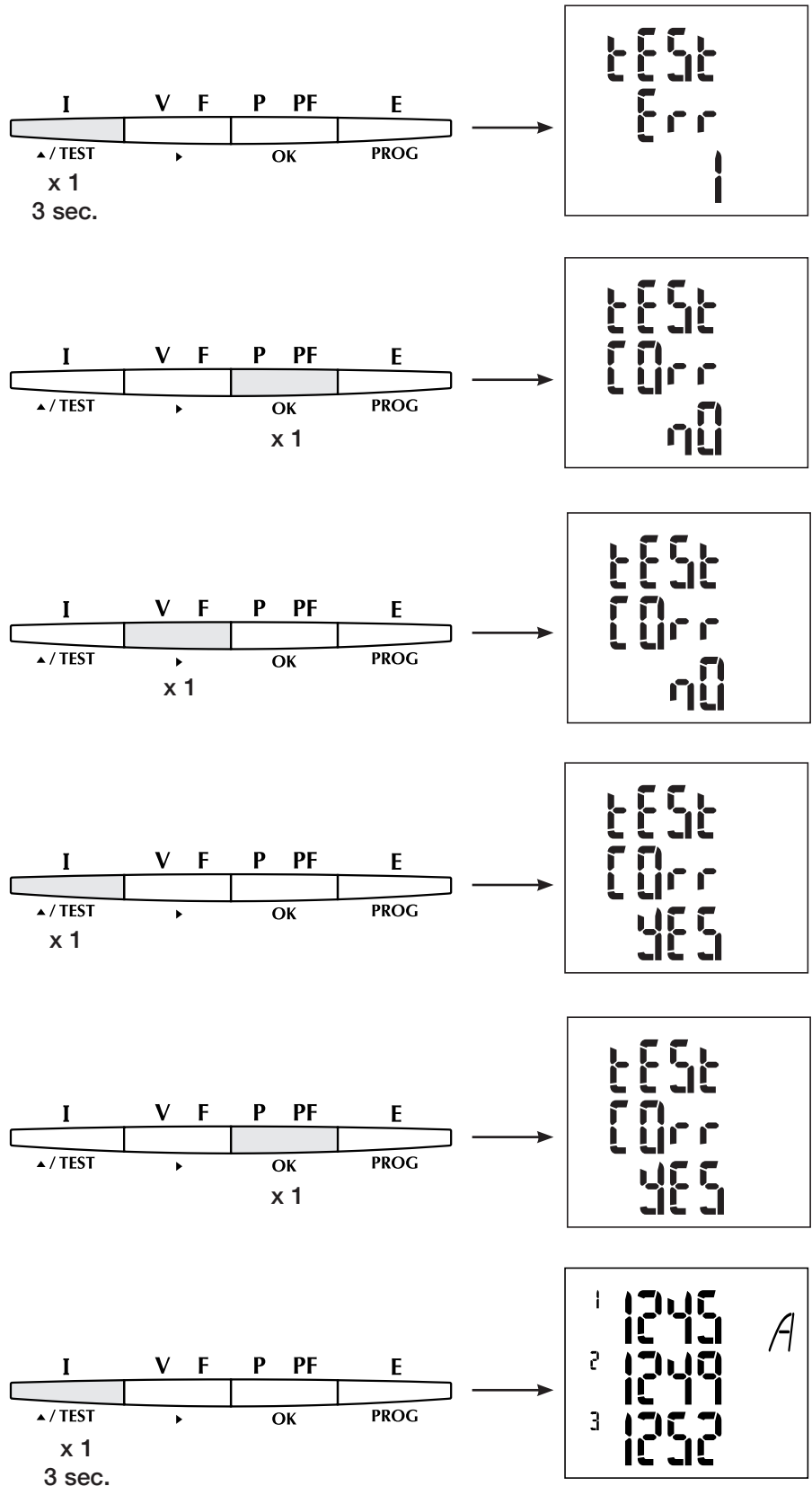

F

> 2^{ème} opération de test

Ce menu s'affiche si le produit a déjà été testé. Cette opération efface les modifications effectuées lors du premier test et permet de re-tester intégralement le raccordement du produit.

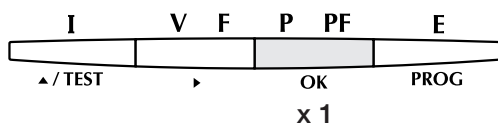
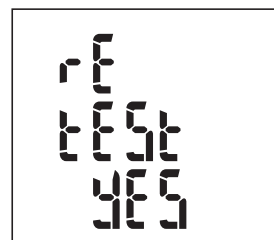
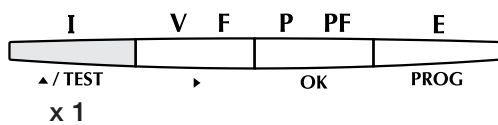
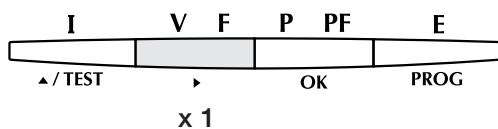
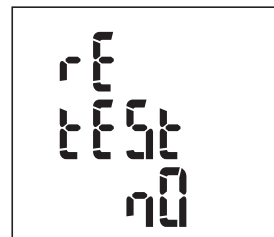
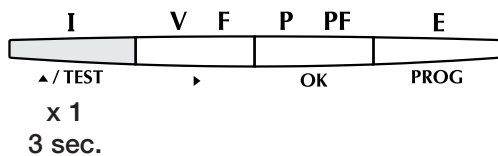

⋮
↓
Opération test

DIRIS A20

CARACTÉRISTIQUES TECHNIQUES

BOÎTIER

Dimensions :	96 x 96 x 60 mm 96 x 96 x 80 avec tous les modules d'options (DIN 43700)
Raccordement :	à partir de borniers débrochables 2,5 mm ² (tensions et autres) et fixes 6 mm ² (courants)
Indice de protection :	Face avant IP52 et boîtier IP30
Poids :	400 g

AFFICHEUR

Type :	LCD avec rétroéclairage
--------	-------------------------

MESURE

Réseau triphasé (3 ou 4 fils), biphasé (2 fils) et monophasé

TENSION (TRMS)

Mesure directe :	Phases/phases : de 50 à 520 V AC Phase/neutre : de 28 à 300 V AC
Surcharge permanente entre phases :	800 V AC
Période d'actualisation :	1 s

COURANT (TRMS)

A partir du TC avec un :	• Primaire : jusqu'à 9 999 A • Secondaire : 5 A
Courant minimum de mesure	5 mA
Consommation des entrées :	< 0,6 VA
Affichage :	de 0 à 11 kA (1,1 fois la valeur du primaire)
Surcharge permanente :	6 A
Surcharge intermittente :	10 In pendant 1 s
Période d'actualisation :	1 s

PUISSANCES

Totales :	0 à 11 MW/Mvar/MVA
Période d'actualisation :	1 s

FREQUENCE

	de 45,0 à 65,0 Hz
Période d'actualisation :	1 s

PRÉCISION DES MESURES

Courants :	0,2 % de 10 à 110 % de In
Tensions :	0,2 % de 140 à 700 V AC
Puissances :	0,5 % de la pleine échelle (-90° à + 90°)
Facteur de puissance :	0,5 % pour 0,5 < FP < 1
Fréquence :	0,1 % de 45 à 65 Hz
Comptage de l'énergie active :	± 0,5% de 0,02 à 1,2 In avec PF = 0,5 L ou 0,8 C (classe 0,5S CEI 62053-22)
Comptage de l'énergie réactive :	± 2% de 0,1 à 1,2 In avec sinφ = 0,5 L ou C (classe 2 CEI 62053-23)

ALIMENTATION AUXILIAIRE CEI/CE

110 à 400 V AC 50/60 Hz	± 10 %
120 à 350 V DC :	± 20 %
Consommation :	< 10 VA

PRÉCISION

Énergie active :	CEI 62053-22 classe 0,5S
Énergie réactive :	CEI 62053-23 classe 2

MARQUAGE CE

Le **DIRIS A20** satisfait aux :

- dispositions de la directive européenne Compatibilité Electromagnétique (CEM) 2004/108/CE du 15.12.04 ;
- à la directive basse-tension 2006/95/CE du 12.12.06.

COMPATIBILITÉ ÉLECTROMAGNÉTIQUE

Immunité aux décharges électrostatiques:	CEI 61000-4-2 - Niveau III
Immunité aux champs électromagnétiques rayonnés:	CEI 61000-4-3 - Niveau III
Immunité aux transitoires rapides en salve:	CEI 61000-4-4 - Niveau III
Immunité aux ondes de choc:	CEI 61000-4-5 - Niveau III
Immunité aux perturbations induites par les champs radioélectriques:	CEI 61000-4-6 - Niveau III
Immunité aux champs magnétiques à la fréquence réseau:	CEI 61000-4-8 - Niveau III
Emissions conduites et rayonnées:	CISPR11 - Classe A
Immunité aux creux et coupures brèves de tension:	CEI 61000-4-11

CLIMAT

Température de fonctionnement :	CEI 60068-2-1/CEI 60068-2-2 -10 °C à +55°C (14°F à 131°F)
Température de stockage :	CEI 60068-2-1/CEI 60068-2-2 -20 °C à +85°C (-4°F à 158 °F)
Humidité :	CEI 60068-2-30 - 95 %
Brouillards salins :	CEI 60068-2-52 - 2,5 % NaCl

CARACTERISTIQUES MECANIQUES

Vibration comprise entre 10 et 50 Hz :	CEI 60068-2-6 - 2 g
--	---------------------

ISOLATION

Catégorie d'installation :	III (480 VAC ph /ph)
Degré de pollution :	2
Tension de choc assignée :	CEI 60947-1 - V imp: 4 kV
Face avant :	Classe II
Sécurité électrique :	CEI 61010-1

CONFORMITE UL

Alimentation auxiliaire	110 à 240 V AC 120 à 250 V DC
Normes	UL 61010-1 CSA-C22.2 No. 61010-1 (cULus)
Certificat	N° de dossier UL: E257746

Utilisation Intérieure

Altitude jusqu'à 2000 m.

Température 0 à 40 °C. 80 % d'humidité relative maximum, pour une température supérieure à 31 °C l'humidité décroît linéairement pour atteindre 50 % à 40 °C

Surtension transitoire conformément à la catégorie d'installation.

Catégories de surtension I, II et III.

Pour la plupart des alimentations la catégorie minimum est la catégorie II.

DIRIS A20

ASSISTANCE

- **Appareil éteint**
Vérifiez l'alimentation auxiliaire.
- **Rétroéclairage éteint**
Vérifiez la configuration du rétroéclairage (p. 42).
- **Tensions = 0**
Vérifiez le raccordement.
- **Courants = 0 ou erronés**
Vérifiez le raccordement.
Vérifiez la configuration du TC.
- **Puissances et facteurs de puissance (PF) erronés**
Lancez la fonction de test du raccordement (p. 47).
- **Phases manquantes sur l'afficheur**
Vérifiez la configuration du réseau (p. 37).

LEXIQUE DES ABRÉVIATIONS

nEt	Type de réseau
4NBL	Réseau triphasé non équilibré, 4 fils avec 3 ou 4 TC
4BL	Réseau triphasé équilibré, 4 fils avec 1 TC
3NBL	Réseau triphasé non équilibré, 3 fils avec 2 ou 3 TC
3BL	Réseau triphasé équilibré, 3 fils avec 1 TC
2BL	Réseau biphasé, 2 fils avec 1 TC
1BL	Réseau monophasé, 2 fils avec 1 TC
Ct	Transformateur de courant
MAX	Valeurs maximales moyennes
tIME 4I	Temps d'intégrations des valeurs maximales en courant
tIME P	Temps d'intégrations des valeurs maximales en puissances
rSET	Reset
MAX P	Valeur maximale de la puissance active moyenne
EA	Energie active (kWh)
ER	Energie réactive (kvarh)
AUX	Alimentation auxiliaire
bACLIt	Démarrage du rétro éclairage sur présence U ou I ou AUX ou ON
≡	Numéro de série
SOft	Version logicielle
THD I1, I2, I3	Taux de distorsion harmonique des courants
THD U12, U23, U31	Taux de distorsion harmonique des tensions composées
THD V1, V2, V3	Taux de distorsion harmonique des tensions simples

ADVERTENCIA	55
OPERACIONES PREVIAS	55
PRESENTACIÓN	55
INSTALACIÓN	56
PROGRAMACIÓN	61
UTILIZACIÓN.....	70
CONEXIÓN PRUEBA FUNCIÓN	73
CARACTERÍSTICAS TÉCNICAS	76
ASISTENCIA.....	78
LÉXICO DE LAS ABREVIACIONES.....	78

DIRIS A20

ADVERTENCIA

El montaje de estos materiales sólo puede ser efectuado por profesionales.
No respetar las indicaciones del presente manual exime de responsabilidad al fabricante.

Riesgo de electrocución, de quemaduras o de explosión

- La instalación y mantenimiento de este aparato debe ser efectuado por personal cualificado.
- Antes de cualquier intervención en el aparato, cortar sus entradas de tensión, corto-circuitar el secundario de cada transformador de intensidad (PTI SOCOMEC) y cortar la alimentación auxiliar de aparato.
- Utilizar siempre un dispositivo de detección de tensión apropiado para asegurar la ausencia de tensión.
- Volver a colocar todos los dispositivos, tapas y puertas antes de poner el aparato en tensión.
- Utilizar siempre la tensión asignada apropiada para alimentar el aparato.

No respetar estas precauciones podría entrañar un serio riesgo de producir heridas graves.

Riesgo de deterioros de aparato

Veáse por respetar:

- La tensión de alimentación auxiliar.
- La frecuencia de la red 50 o 60 Hz.
- Una tensión máxima en las bornas de entradas de tensión (V1, V2, V3 y VN) de 520 V AC fase/fase o de 300 V AC entre fase/neutro.
- Intensidad máxima de 6 amperios en bornas de las entradas de intensidad (I1, I2, I3).

OPERACIONES PREVIAS

Para la seguridad del personal y del material, será imperativo conocer perfectamente el contenido de este manual antes de su puesta en funcionamiento.

Al recibir el paquete que contiene el **DIRIS A20**, será necesario verificar los aspectos siguientes:

- estado del embalaje,
- que el producto no se haya dañado durante el transporte,
- que la referencia del Aparato esté conforme con su pedido,
- el embalaje incluye el producto equipado con una caja de bornes desenchufable,
- el manual de utilización.

PRESENTACIÓN

Los **DIRIS A20** son dos analizadores de redes que ponen a disposición del usuario todas las medidas necesarias para llevar a buen término todo tipo de proyectos de eficacia energética y garantizar la supervisión de la distribución eléctrica.

1. Teclado compuesto por 4 teclas de doble función (visualización o configuración)
2. Indicador LCD retroiluminado
3. Fase
4. Valores
5. Unidad
6. Indicador de actividad en el bus de comunicación
7. Indicador de conteo de energía



DIRIS A20

INSTALACIÓN

RECOMENDACIONES

- Evitar la proximidad con los sistemas generadores de perturbaciones electromagnéticas.
- Evitar las vibraciones que provocan aceleraciones superiores a 1 g para frecuencias inferiores a 60 Hz.

DIMENSIONES

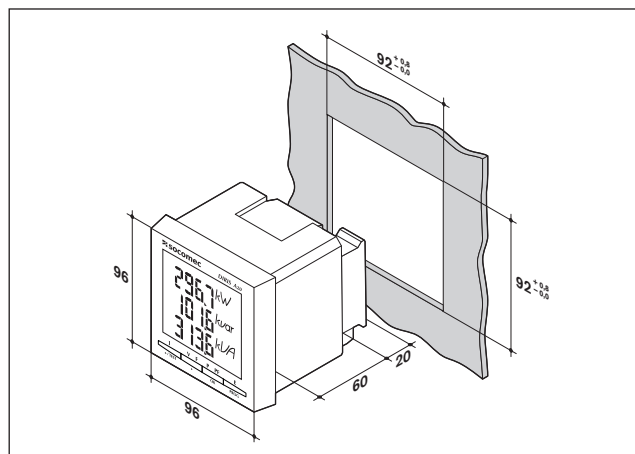

MONTAJE

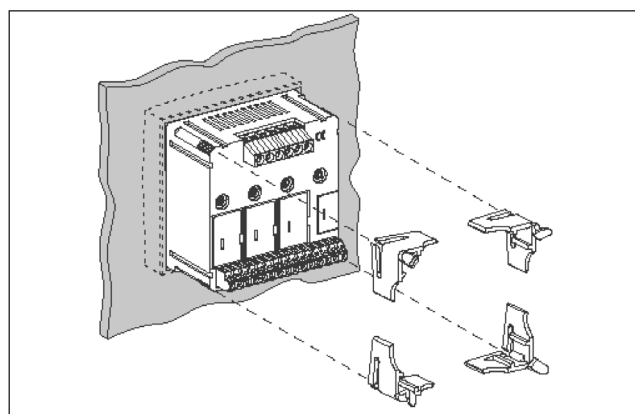

PARTE TRASERA

El par de apriete máximo para cada tornillo es de 0,4 Nm. En caso de desconexión del **DIRIS**, es indispensable cortocircuitar los secundarios de cada transformador de intensidad. Esta manipulación puede hacerse automáticamente a partir de un producto del catálogo de SOCOMEC: el PTI. Para mayor información sobre este producto, le agradeceremos consultarnos.

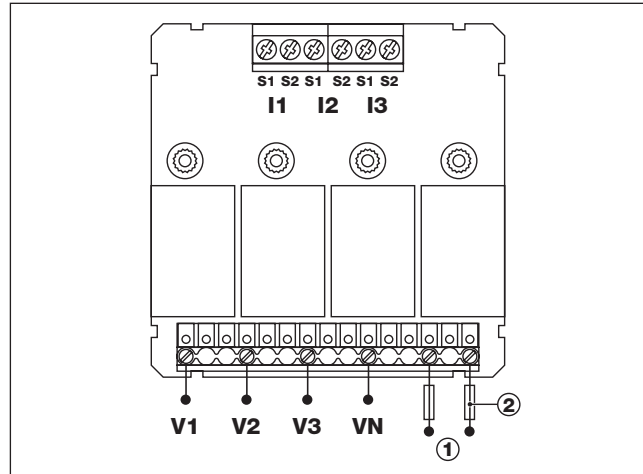

① Aux.:	IEC/CE	110... 400V AC 120... 350V DC
	UL	110... 240V AC 120... 250V DC

② Fus.: 0.5 A gG / BS 88 2A gG / 0.5 A class CC

MODULOS OPCIONES

Los **DIRIS A20** pueden estar equipados con distintos módulos opcionales:

- **Comunicación JBUS/MODBUS (ref.: 48250082)**
Enlace de serie RS485 JBUS/MODBUS en modo RTU con una velocidad comprendida entre 2.400 y 38.400 baudios.
(Instrucciones de servicio ref.: 536085).
- **Salida de impulsos (ref.: 48250080)**
1 salida configurable:
 - impulsos: configurable para las energías kWh y kvarh;
 - alarma: vigilancia de los parámetros;
 - control remoto: para el mando a distancia del aparato de corte.
 (Instrucciones de servicio ref.: 536037).

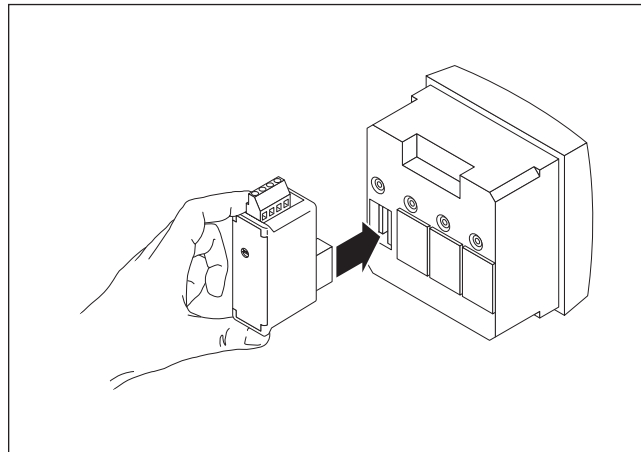

DIRIS A20

INSTALACIÓN

RED TRIFÁSICA DESEQUILIBRADA (3NBL / 4NBL)

La solución con 2 TI disminuye de 0,5 % la precisión de las mediciones de las fases sin transformador ya que el valor de la intensidad se deduce vectorialmente.



En esquema IT, no conectar los secundarios de los TI a tierra.

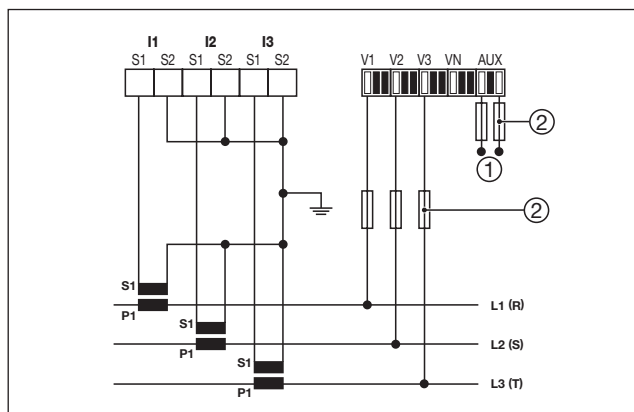
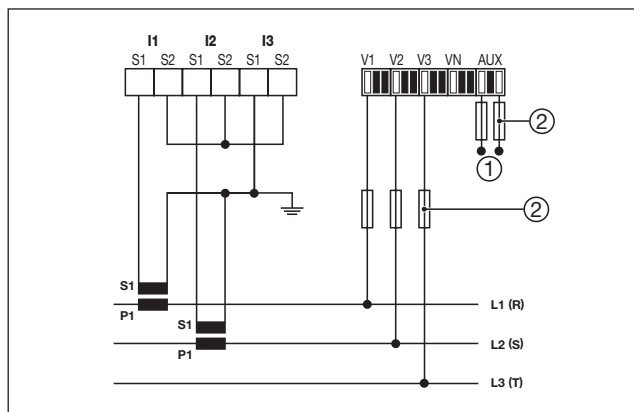
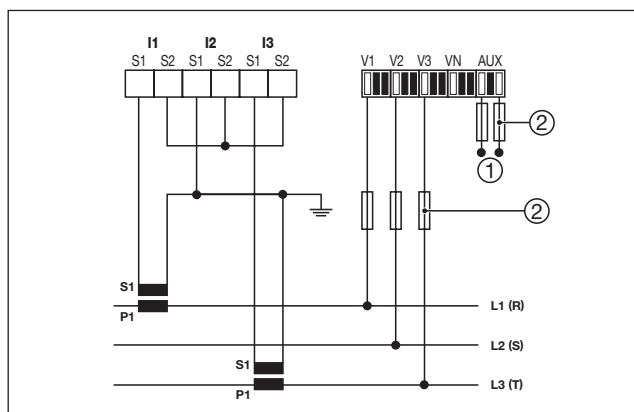
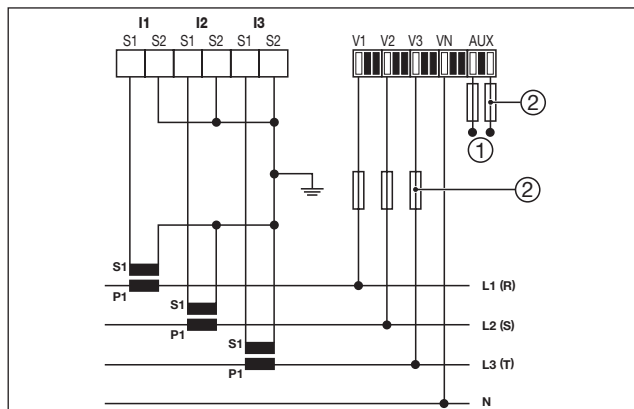

① Aux.: IEC/CE 110... 400V AC
120... 350V DC

UL 110... 240V AC
120... 250V DC

② Fus.: 0.5 A gG / BS 88 2A gG / 0.5 A class CC

RED TRIFÁSICA EQUILIBRADA (3BL/4BL)

La solución con 1 TI disminuye de 0,5 % la precisión de las medición de las fases sin transformador ya que el valor de la intensidad se deduce vectorialmente

 En esquema IT, no conectar los secundarios de los TI a tierra.

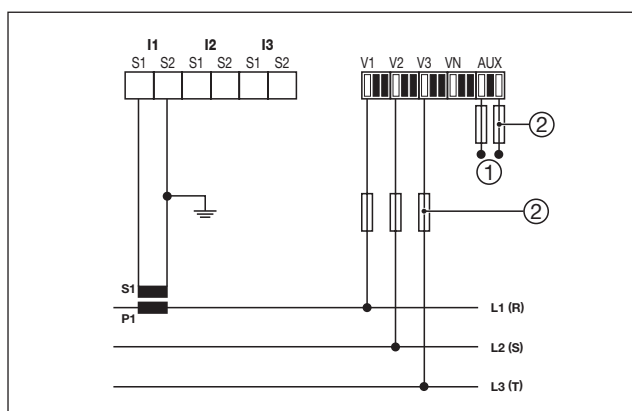
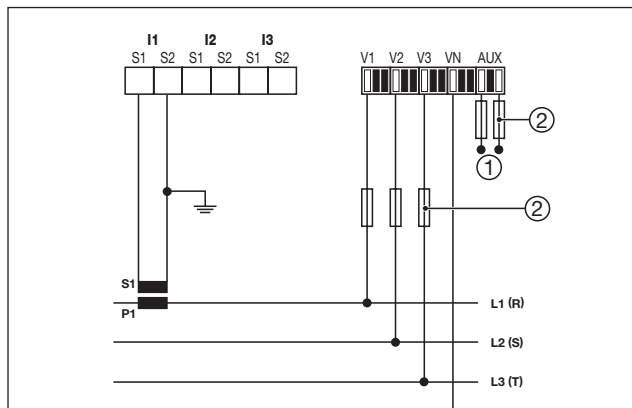

① Aux.: IEC/CE 110... 400V AC
120... 350V DC

UL 110... 240V AC
120... 250V DC

② Fus.: 0.5 A gG / BS 88 2A gG / 0.5 A class CC

DIRIS A20

INSTALACIÓN

RED BIFÁSICA (2BL)



En esquema IT, no conectar los secundarios de los TI a tierra.

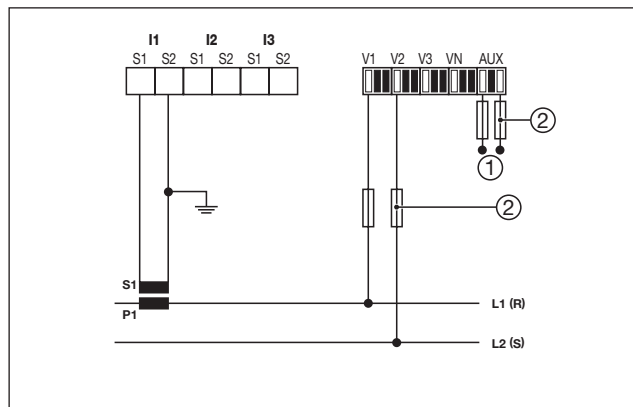

① Aux.: IEC/CE 110... 400V AC
120... 350V DC
UL 110... 240V AC
120... 250V DC

② Fus.: 0.5 A gG / BS 88 2A gG / 0.5 A class CC

RED MONOFÁSICA (1BL)



En esquema IT, no conectar los secundarios de los TI a tierra.

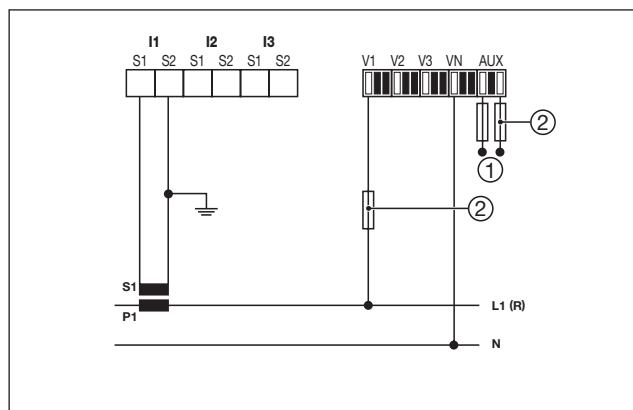

① Aux.: IEC/CE 110... 400V AC
120... 350V DC
UL 110... 240V AC
120... 250V DC

② Fus.: 0.5 A gG / BS 88 2A gG / 0.5 A class CC

DIRIS A20

PROGRAMACIÓN

PROGRAMACIÓN MENÚ

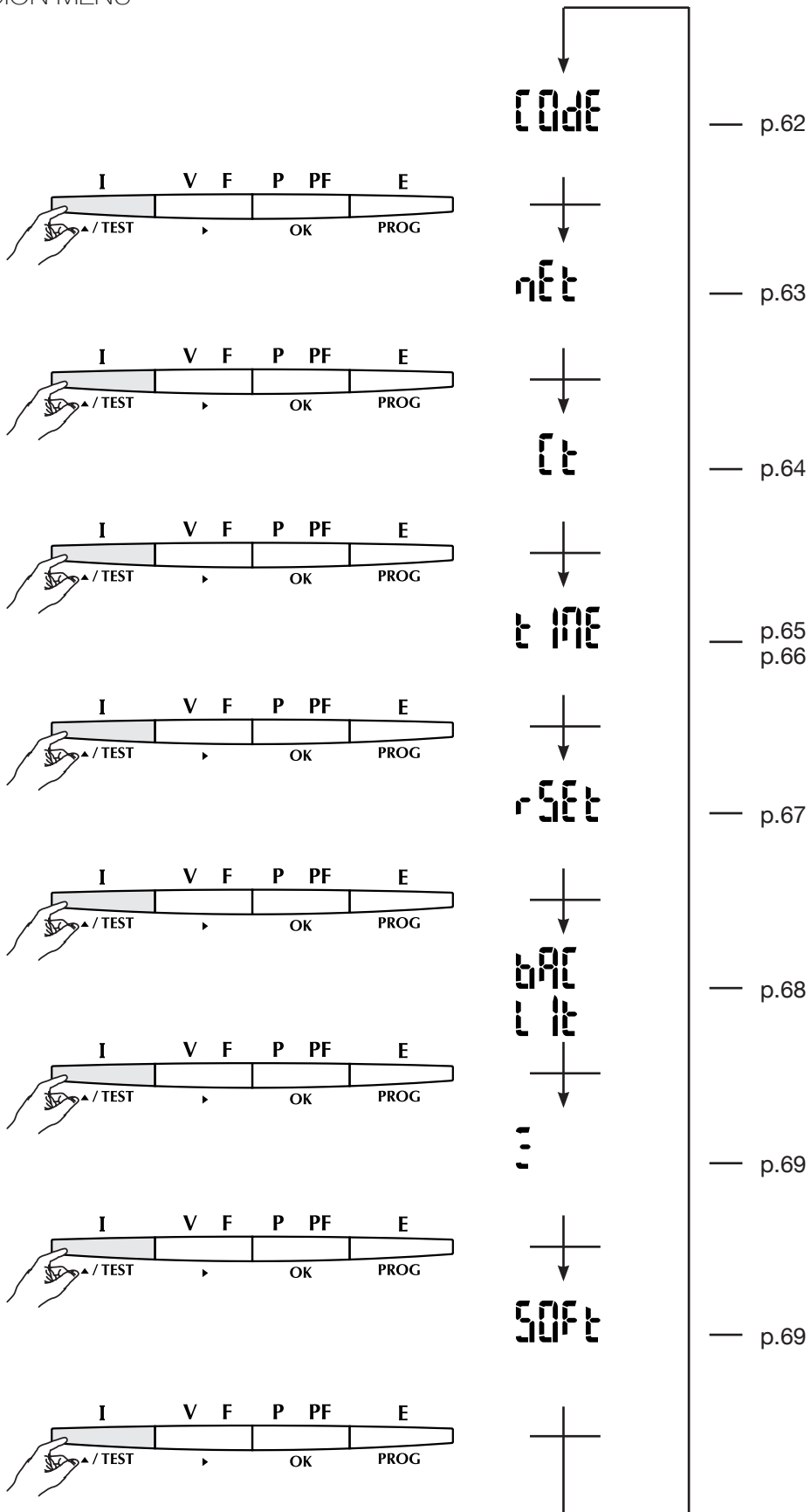

E

DIRIS A20

PROGRAMACIÓN

ENTRAR EN MODO PROGRAMACIÓN (ejemplo, CODE = 100)

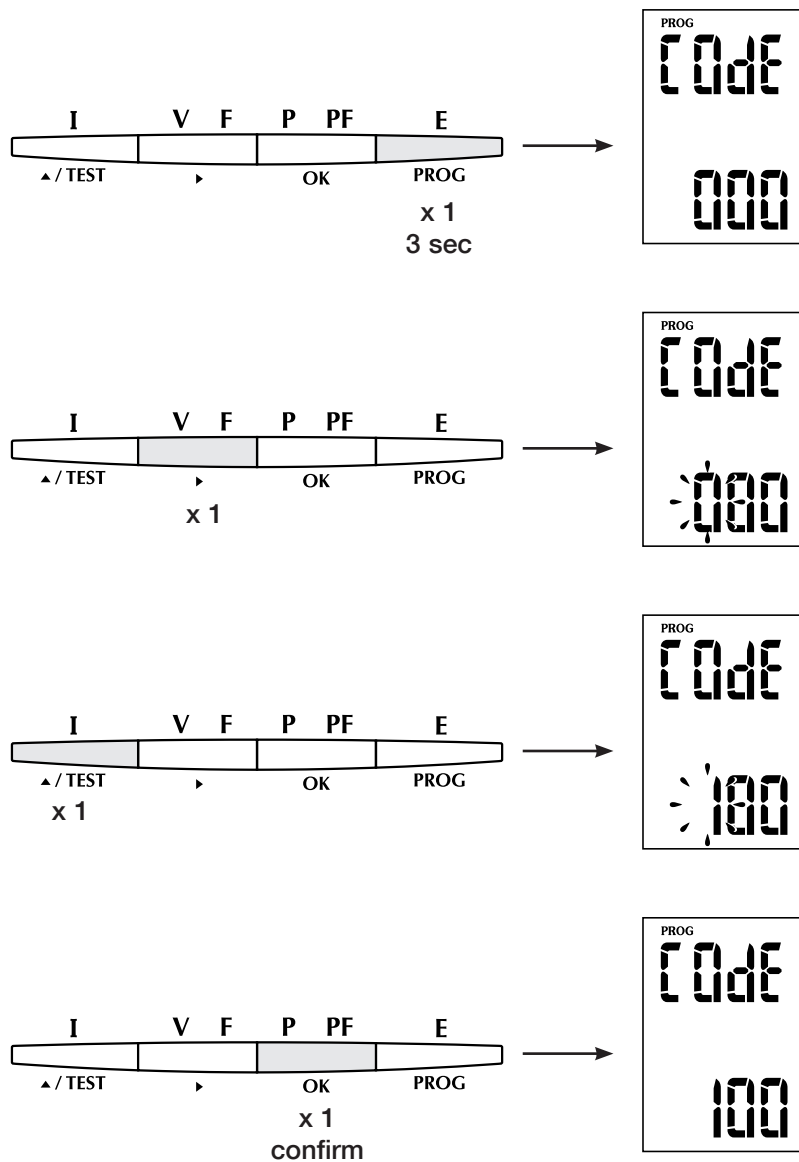

FRECUENCIA (ejemplo, nEt = 3nbl)

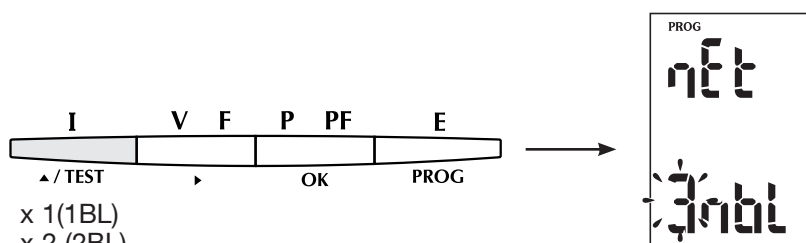
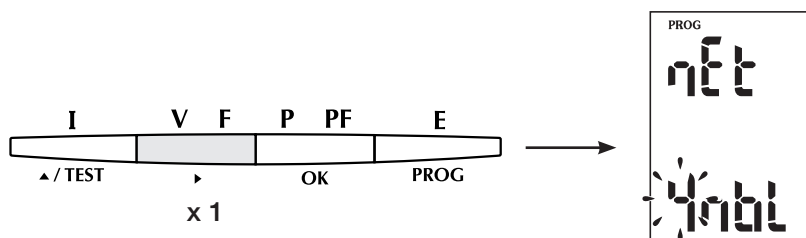

- x 1(1BL)
- x 2 (2BL)
- x 3 (3BL)
- x 4 (3NBL)**
- x 5 (4BL)
- x 6 (4NBL)

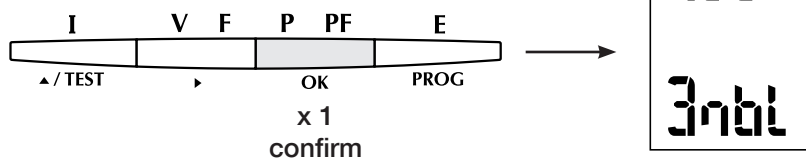

DIRIS A20

PROGRAMACIÓN

TRANSFORMADOR DE CORRENTE (ejemplo, Ct = 1200 / 5A)

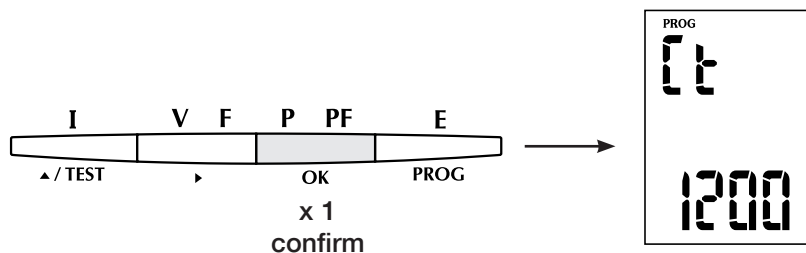
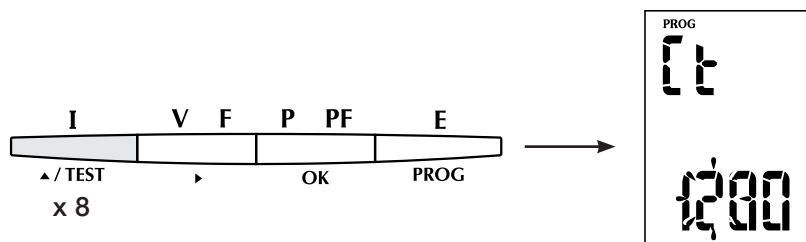
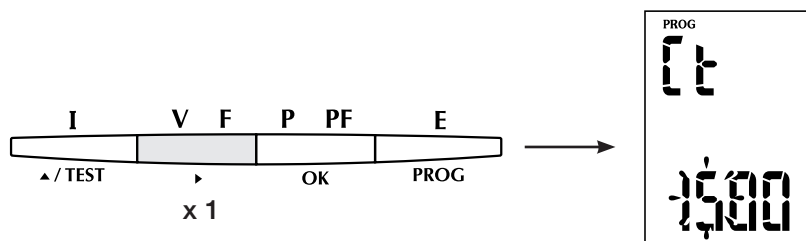
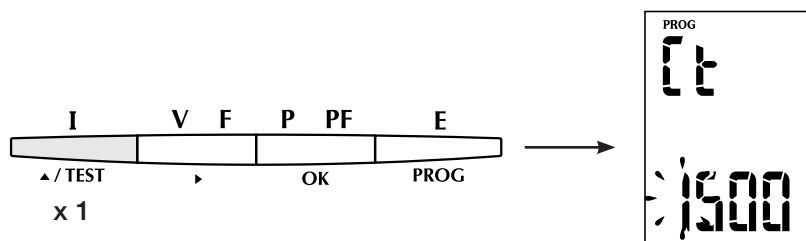
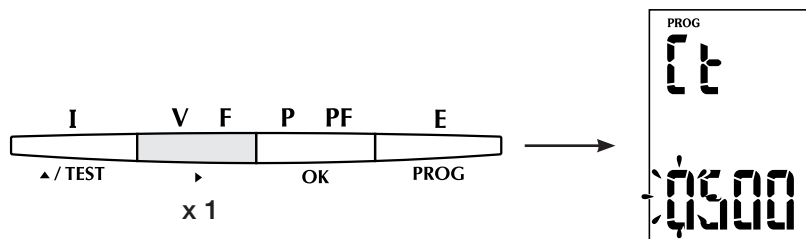

INTEGRACIÓN DE LAS INTENSIDADES (ejemplo, tIME = 20 min)

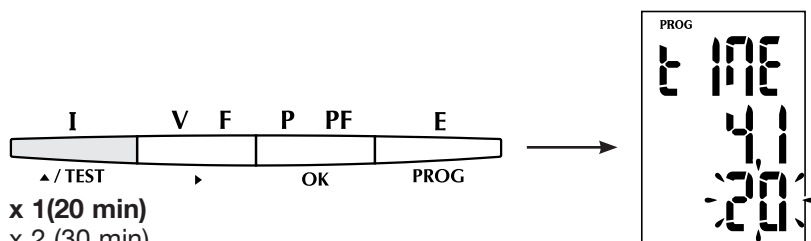
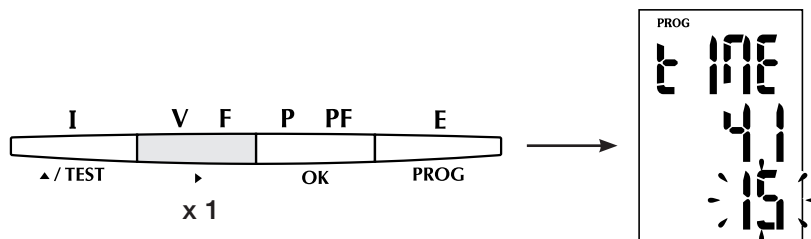

- x 1 (20 min)
- x 2 (30 min)
- x 3 (60 min)
- x 4 (2 sec)
- x 5 (5 min)
- x 6 (8 min)
- x 7 (10 min)
- x 8 (15 min)

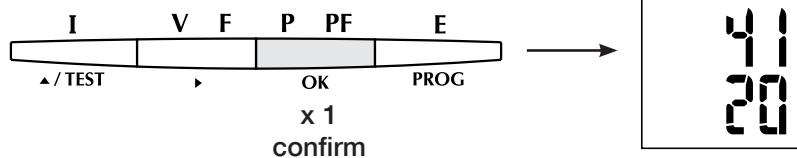

E

DIRIS A20

PROGRAMACIÓN

INTEGRACIÓN DE LAS POTENCIA ACTIVA (ejemplo, tIME = 20 min)

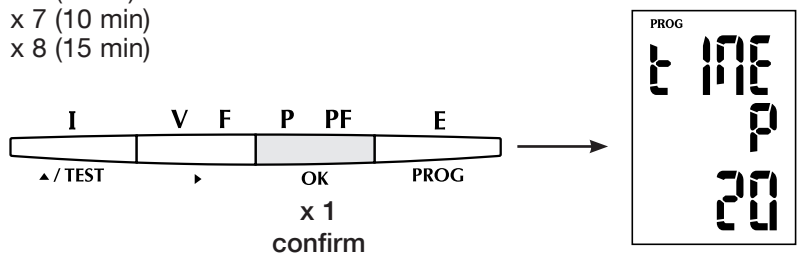
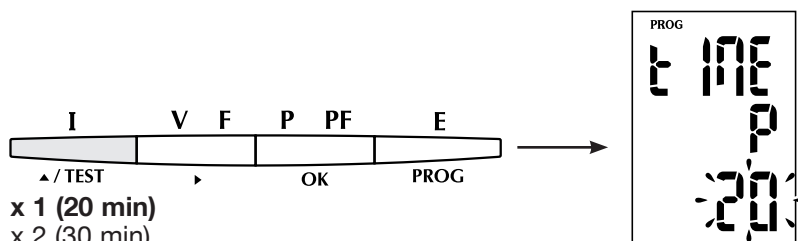
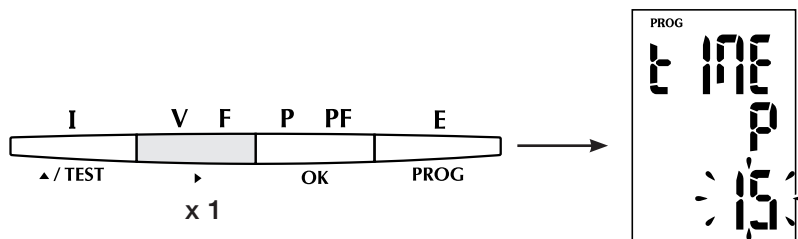

VOLVER A CERO (ejemplo, rSEt = Ea)

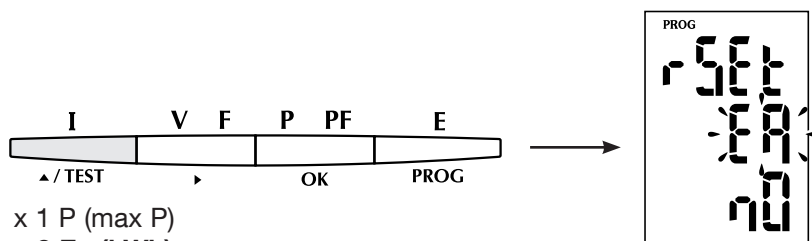
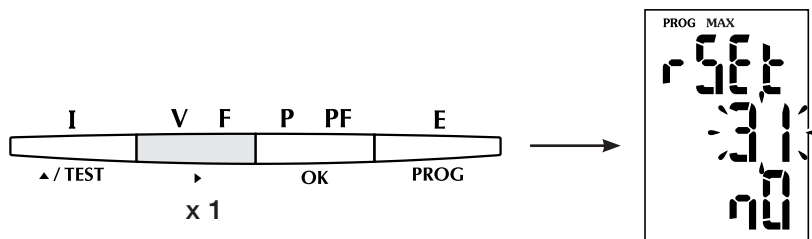

- x 1 P (max P)
- x 2 Ea (kWh)**
- x 3 Er (kvarh)
- x 4 3I (max 4I)

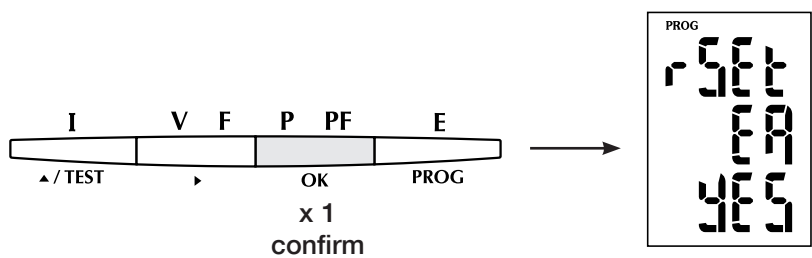
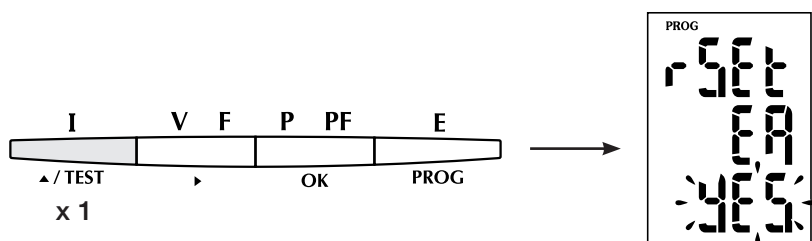
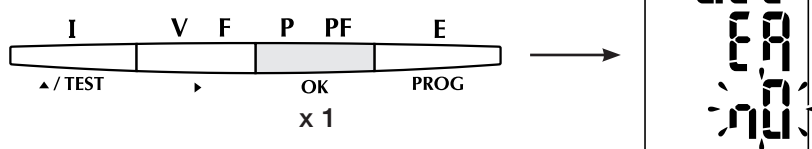

DIRIS A20

PROGRAMACIÓN

RETROILUMINACIÓN (ejemplo, bACLIt = U)

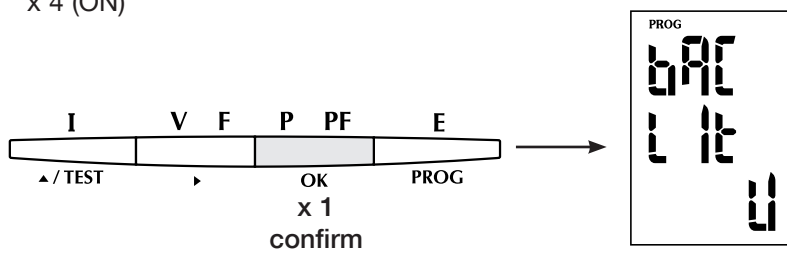
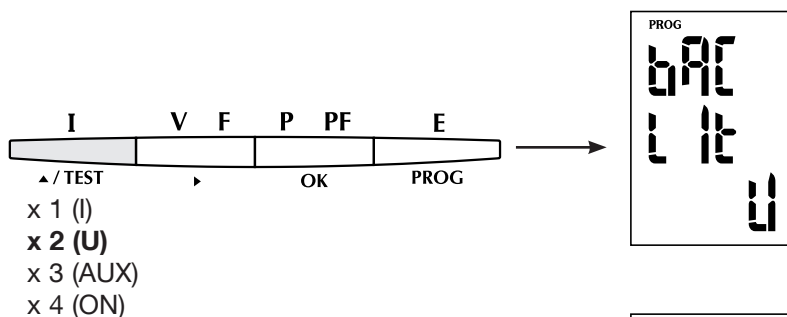
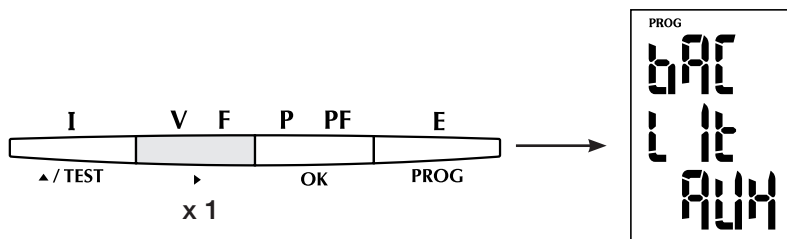

NÚMERO DE SERIE (ejemplo, 05312784623)

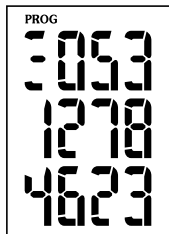

VERSIÓN DE SOFTWARE



PARA SALIR DE LA PROGRAMACIÓN

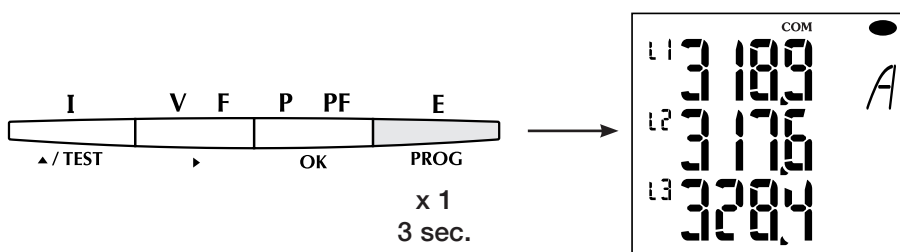

DIRIS A20

UTILIZACIÓN

I - CURRENT

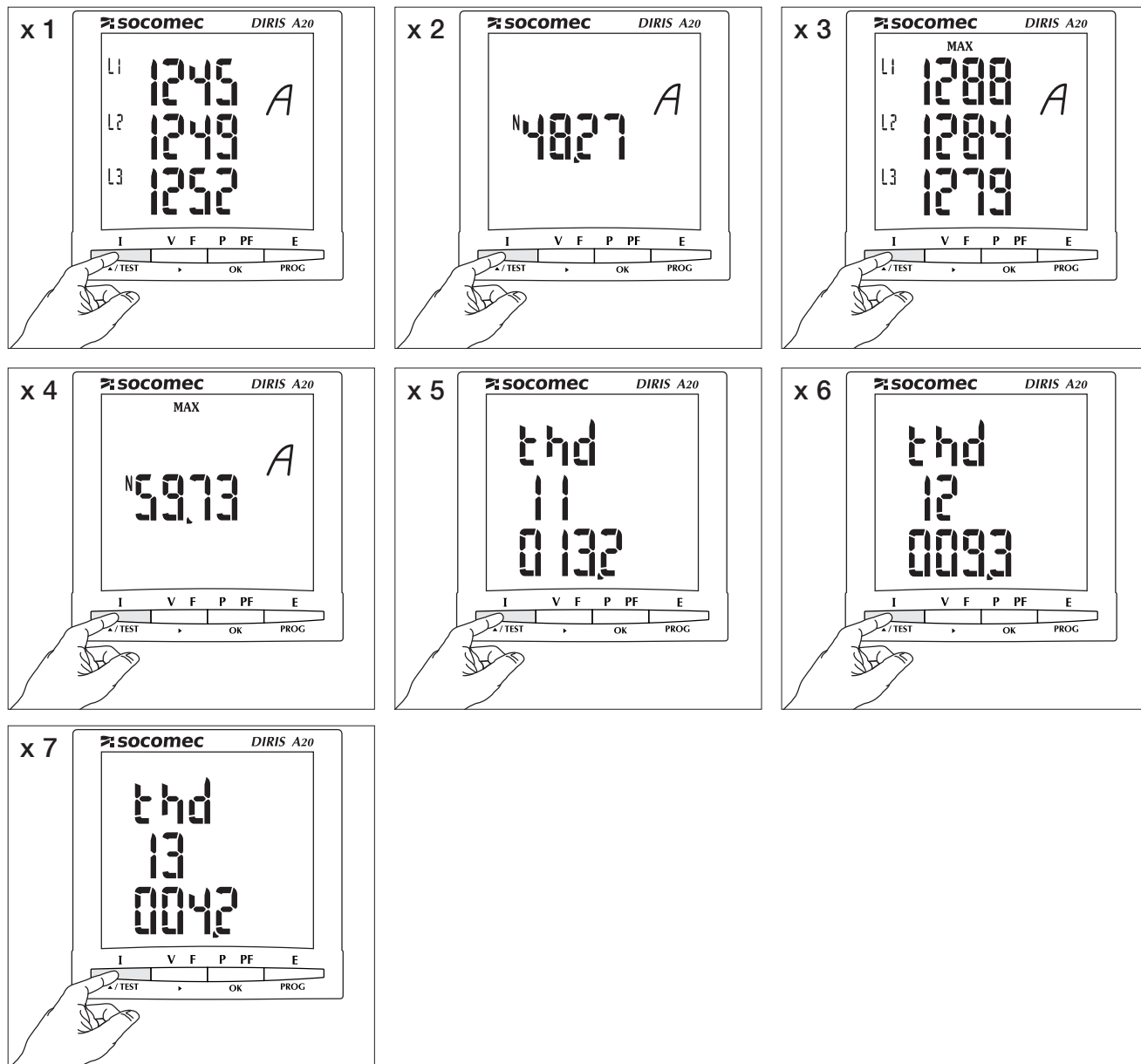

V/F - VOLTAGE/FREQUENCY

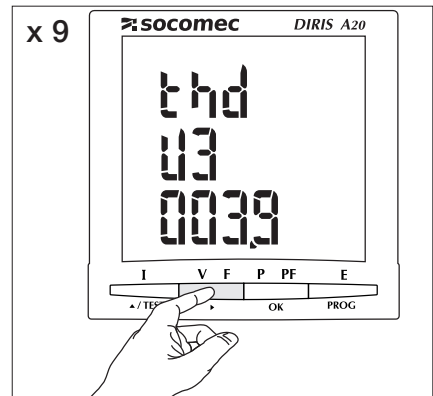
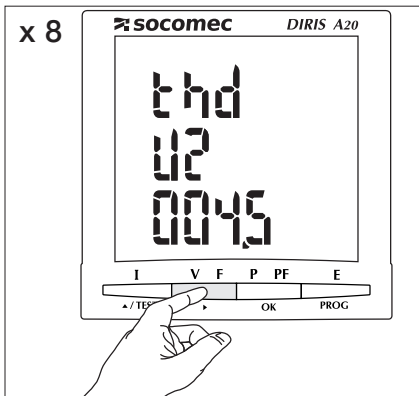
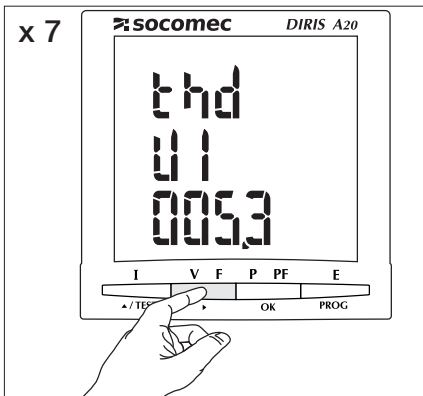
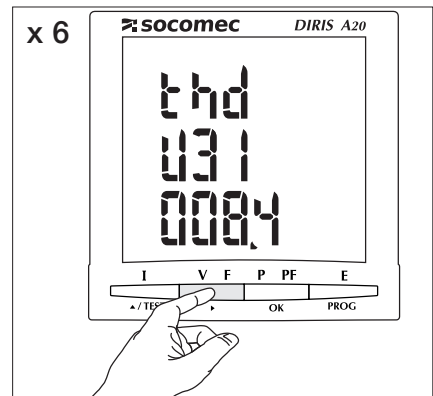
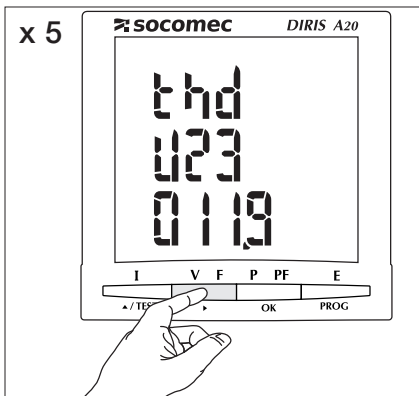
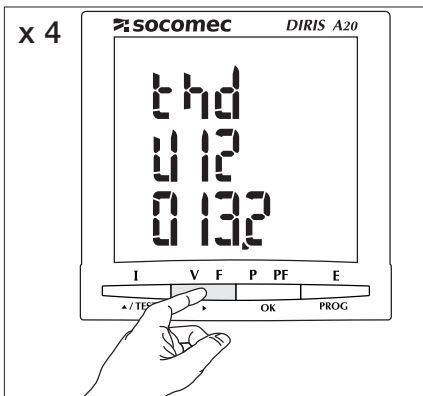
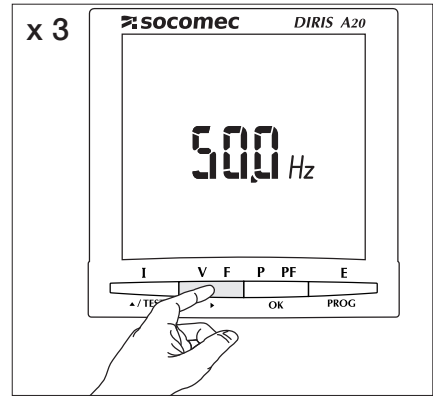
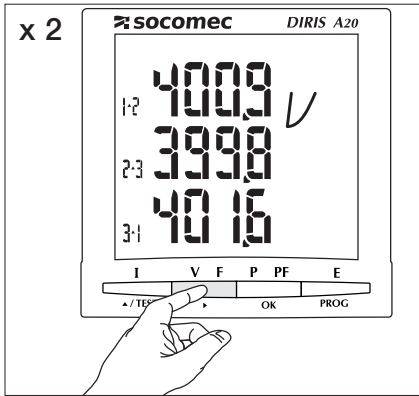
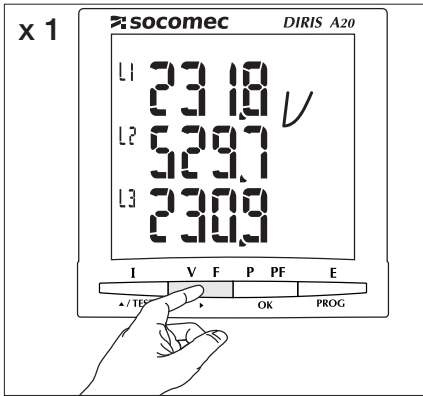

DIRIS A20

UTILIZACIÓN

P/PF - POWER/POWER FACTORY



E - ENERGY

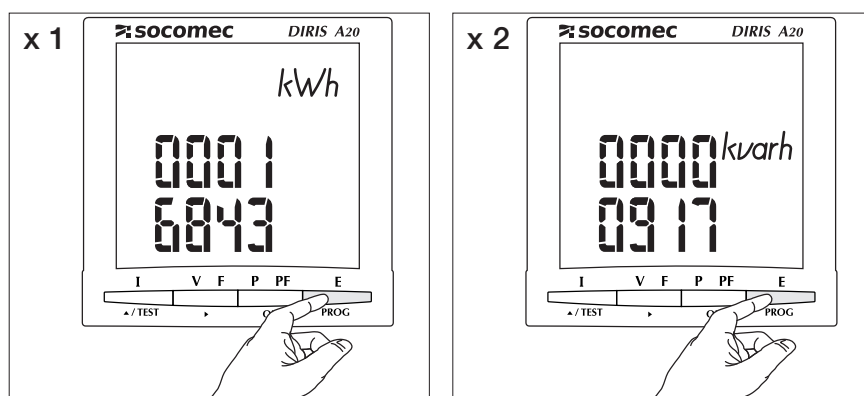

DIRIS A20

CONEXIÓN PRUEBA FUNCIÓN

Durante la prueba, el **DIRIS** debe recibir corriente y tensión en cada una de las fases.

Además, esta función debe tener una carga de al menos 20% más de la carga nominal con un factor de potencia (FP), entre 0,6 inductivo $<FP < 1$.

Si estos dos criterios no se cumplen, esta función no se puede utilizar, y la prueba no se iniciará.

En los modelos 4BL / 3BL / 2BL / 1BL, sólo la conexión TI está controlado.

En los modelos 4NBL y 3NBL, toda la conexión está controlada.

A lista de erros:

Err 0 = ningún error

Err 1 = inversión de la conexión TI fase 1

Err 2 = inversión de la conexión TI fase 2

Err 3 = inversión de la conexión TI fase 3

Err 4 = inversión intensidad entre V1 e V2

Err 5 = inversión intensidad entre V2 e V3

Err 6 = inversión intensidad entre V3 e V1.

En el caso de los modelos Err 1, Err 2 y Err 3, la modificación puede realizarse de forma automática a través del DIRIS o manual por medio de la corrección de la conexión de la corriente.

En el caso de los modelos Err 4, Err5 y Err 6, la modificación puede realizarse de forma manual por medio de la corrección de la conexión de la tensión.

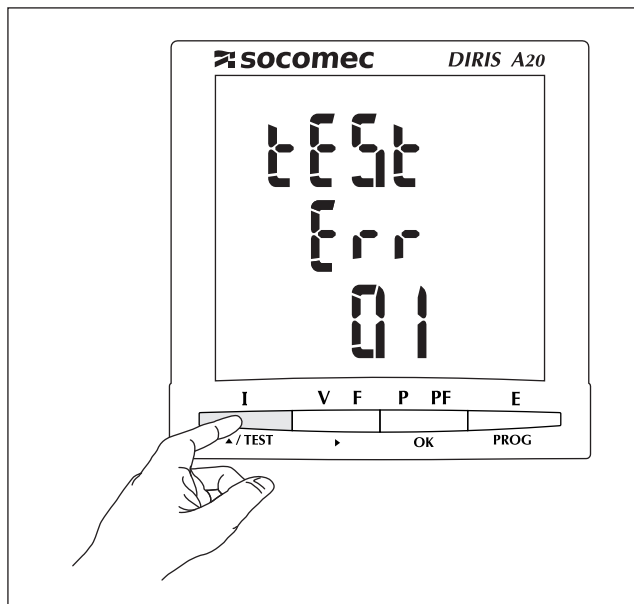

Ejemplo, tEst Err 0

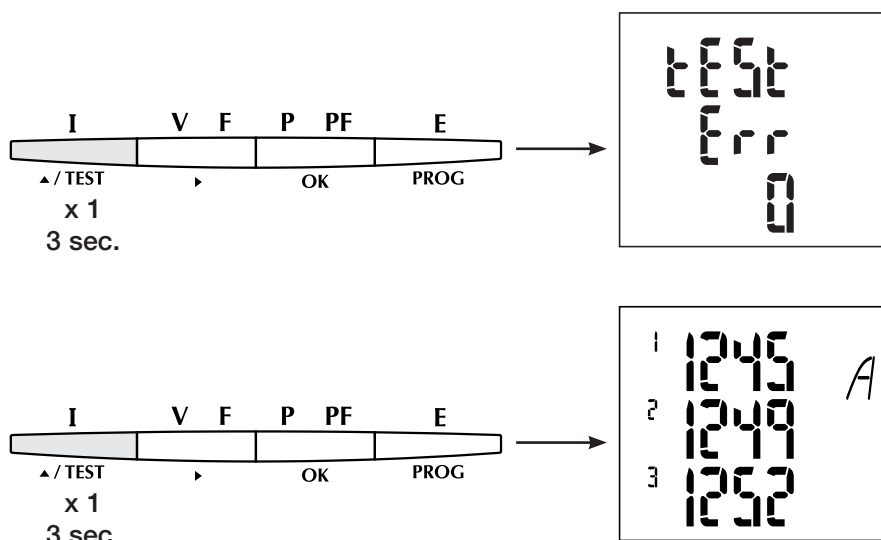

DIRIS A20

CONEXIÓN PRUEBA FUNCIÓN

Ejemplo, tEst Err 1

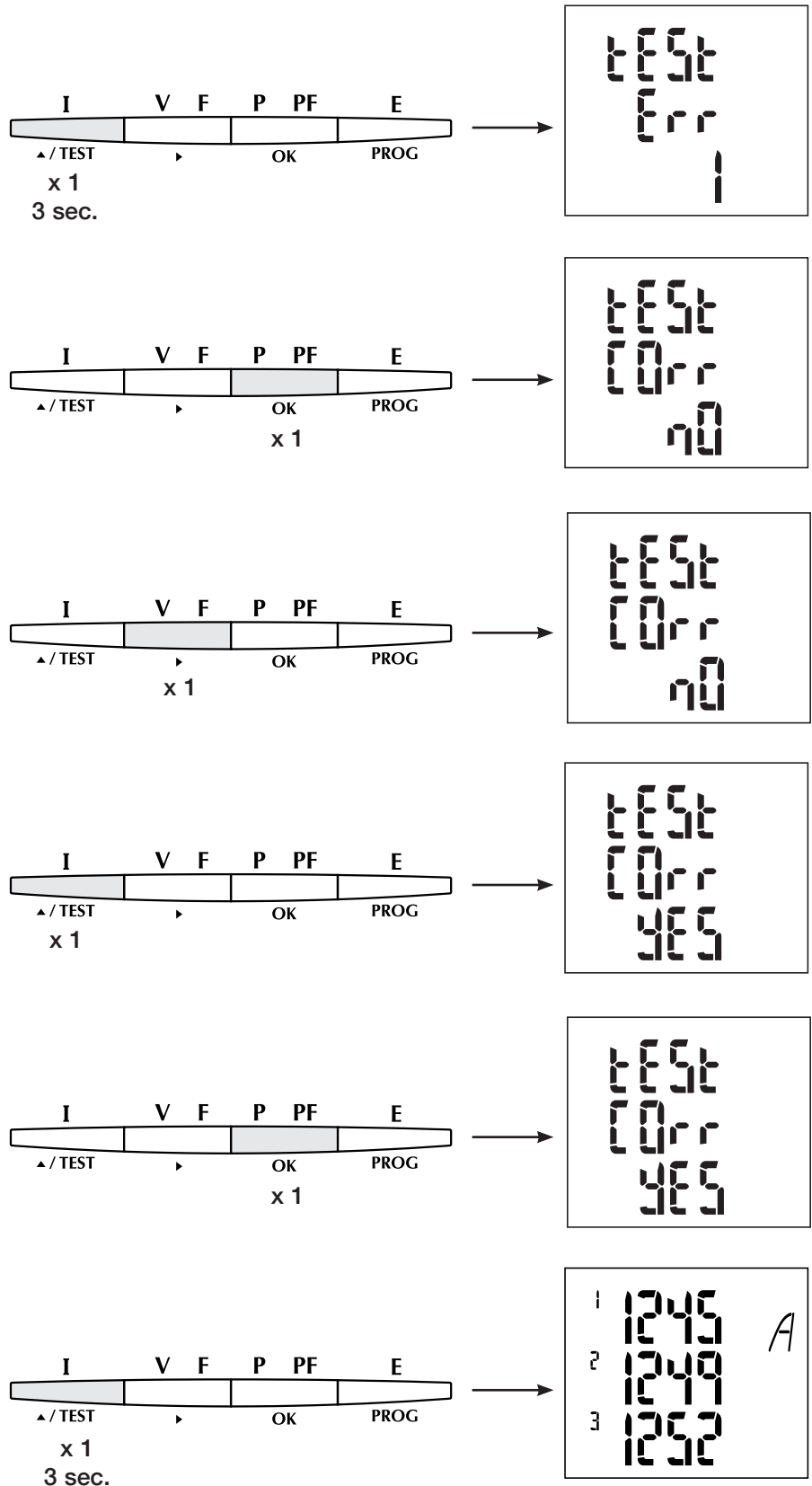

> Segunda operación de prueba

Este menú aparece si el producto ya ha sido probado. Esto borra todos los cambios realizados durante la primera prueba y vuelve a probar plenamente puede conectar el producto.

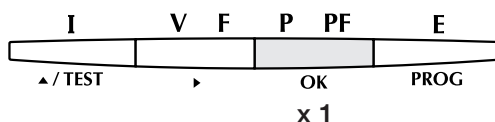
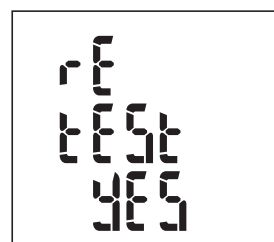
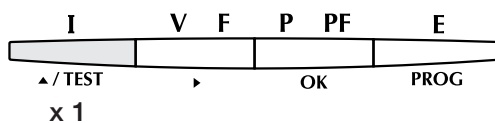
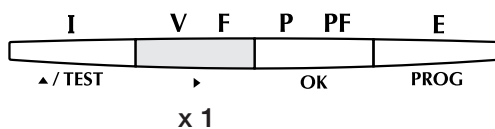
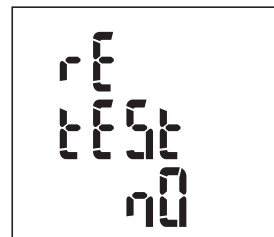
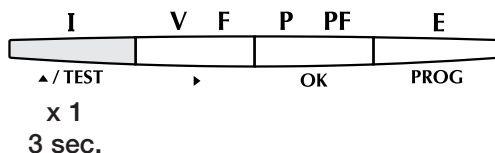

⋮
 ↓
 Segunda operación de prueba



DIRIS A20

CARACTERÍSTICAS TÉCNICAS

CAJA

Dimensiones:	96x96x60 o 80 con todos los módulos de opciones (DIN 43700)
Conexión:	a partir de las cajas de bornes móviles 2,5 mm ² (tensiones y otros) y fijas 6 mm ² (intensidades)
Índice de protección:	Cara frontal IP52 y caja IP30
Peso:	400 gr

VISUALIZADOR

Type:	LCD con retroiluminación
-------	--------------------------

MEDIDAS

Red trifásica (3 o 4 hilos), bifásica (2 hilos) y monofásica
--

TENSIÓN (TRMS)

Medida directa:	Fase/fase	de 50 a 520 V AC
	Fase/neutro	de 28 a 300 V AC
Sobrecarga permanente:	800 V AC	
Periodo de actualización:	1 segundo	

INTENSIDAD (TRMS)

A partir de transformador de intensidad con un:	• Primario	hasta 9 999 A
	• Secundario	5 A
Corriente mínima de medida	5 mA	
Consumo de entradas:	< 0,6 VA	
Visualización	de 0 a 11 kA (1,1 veces el valor del primario)	
Sobrecarga permanente:	6 A	
Sobrecarga intermitente:	10 I _n durante 1 segundo	
Periodo de actualización:	1 segundo	

POTENCIAS

Totales:	0 a 11 MW/Mvar/MVA
Periodo de actualización:	1 segundo

FRECUENCIA

	de 45,0 a 65,0 Hz
Periodo de actualización:	1 segundo

PRECISIÓN DE LAS MEDIDAS

Intensidades:	0,2 % de 10 a 110 % de I _n
Tensiones:	0,2 % de 140 a 700 V AC
Potencias:	0,5 % de la plena escala (-90° a + 90°)
Factor de potencia:	0,5 % para 0,5 < FP < 1
Frecuencia:	0,1 % de 45 a 65 Hz
Recuento de la energía activa:	± 0,5 % de 0,02 a 1,2 I _n con PF = 0,5 L o 0,8 C (clase 0,5S IEC 62053-22)
Recuento de la energía reactiva:	± 2% de 0,1 a 1,2 I _n con sinφ = 0,5 L o C (clase 1 IEC 62053-23)

ALIMENTACIÓN AUXILIAR IEC/CE

110 a 400 V AC	en 50/60 Hz ± 10 %
120 a 350 V DC	± 20 %
Consumo	< 5 VA

PRECISIÓN

Precisión en la energía activa:	IEC 62053-22 classe 0,5S
Precisión en la energía reactiva:	IEC 62053-23 classe 2

MARCADO CE

The **DIRIS A20** complies with:

- the requirements of the European EMC directive n°2004/108/CE dated 15.12.04;
- the European Low voltage directive n° 2006/95/CE dated 12.12.06.

COMPATIBILIDAD ELECTROMAGNÉTICA

Immunity to electrostatic discharges:	IEC 61000-4-2 - Level III
Immunity to radiated radio-frequency fields:	IEC 61000-4-3 - Level III
Immunity to electrical fast transients/bursts:	IEC 61000-4-4 - Level III
Immunity to impulse waves:	IEC 61000-4-5 - Level III
Immunity to conducted disturbances:	IEC 61000-4-6 - Level III
Immunity to power frequency magnetic fields:	IEC 61000-4-8 - Level III
Conducted and radiated emissions:	CISPR11 - Class A
Immunity to voltage dips and short interruptions:	IEC 61000-4-11

CLIMAT

Operating-temperature range:	IEC 60068-2-1/IEC 60068-2-2 -10 °C to +55°C (14° to 131°F)
Storage temperature range:	IEC 60068-2-1/IEC 60068-2-2 -20 °C to +85°C (-4° to 158°F)
Humidity:	IEC 60068-2-30 - 95 %
Saling fog:	IEC 60068-2-52 - 2,5 % NaCl

CARACTERÍSTICAS MECÁNICAS

Vibration from 10 to 50 Hz:	IEC 60068-2-6 - 2g
-----------------------------	--------------------

AI SLAM IENTO

Installation category:	III (480 VAC ph/ph)
Degree of pollution:	2
Rated impulse withstand voltage:	IEC 60947-1 - V imp: 4 kV
Front face:	Class II
Electric security:	IEC 61010-1

UL APPROVAL

Auxiliary supply	110 to 240 V AC 120 to 250 V DC
Standard	UL 61010-1 CSA-C22.2 No. 61010-1 (cULus)
Certificate	UL file No: E257746

Indoor use

Altitude up to 2000 m.

Temperature 0 to 40°C. Maximum relative humidity 80% for temperatures up to 31°C decreasing linearly to 50% relative humidity at 40°C

Transient overvoltages according to installations categories.

Overvoltage categories I,II and III.

For mains supply the minimum and normam category is II.

DIRIS A20

ASISTENCIA

- **Aparato apagado**
Verificar la alimentación auxiliar.
- **Retroiluminación apagada**
Verificar la configuración del display retroiluminado (p. 68).
- **Tensiones = 0**
Verificar las conexiones.
- **Intensidades = 0 o erróneas**
Verificar las conexiones.
Verificar la configuración del TI.
- **Potencias y factor de potencia (PF) erróneos**
Ejecutar la función test de conexión (p. 73).
- **Ausencia de fases en el display**
Verificar la configuración de la red (p. 63).

LÉXICO DE LAS ABREVIACIONES

nEt	Tipo de red
4NBL	Red trifásica desequilibrada, 4 hilo con 3 o 4 TI
4BL	Red trifásica equilibrada, 4 hilo con 1 TI
3NBL	Red trifásica desequilibrada, 3 hilo con 2 o 3 TI
3BL	Red trifásica equilibrada, 3 hilo con 1 TI
2BL	Red bifásica, 2 hilo con 1 TI
1BL	Red monofásica , 2 hilo con 1 TI
Ct	Transformador de intensidad
MAX	Valores máximos medios
tIME 4I	Tiempo de integración de los valores máximos en intensidad
tIME P	Tiempo de integración de los valores máximos en potencias
rSET	Reset
MAX P	Valor máximo de la potencia activa media
EA	Energía activa (kWh)
ER	Energía reactiva (kvarh)
AUX	Alimentación auxiliar
bACLIt	Configuración de la retroiluminación sobre presencia U o I o AUX o ON
≡	Número de serie
SOft	Versión de software
THD I1, I2, I3	Grado de distorsión armónico (thd) de las intensidades
THD U12, U23, U31	Grado de distorsión armónico (thd) de las tensiones compuestas
THD V1, V2, V3	Grado de distorsión armónico (thd) de las tensiones simples

HEAD OFFICE

SOCOMEK GROUP

S.A. SOCOMEK capital 11 149 200 €
R.C.S. Strasbourg B 548 500 149
B.P. 60010 - 1, rue de Westhouse
F-67235 Benfeld Cedex - FRANCE

INTERNATIONAL SALES DEPARTMENT

SOCOMEK

1, rue de Westhouse - B.P. 60010
F - 67235 Benfeld Cedex - FRANCE
Tel. +33 (0)3 88 57 41 41 - Fax +33 (0)3 88 74 08 00
info.scp.isd@socomec.com

www.socomec.com

Non contractual document. © 2012, Socomec SA. All rights reserved.

